

Assembly Instruction

42941934 6 DRAWER CHEST WHITE

CARE INSTRUCTIONS:



WIPE CLEAN WITH A DRY CLOTH.DO NOT USE ABRASIVE MATERIALS AND SOLVENTS.CHECK AND TIGHTEN ALL PARTS REGULARLY.DO NOT PLACE HOT ITEMS SUCH AS COFFEE CUPS DIRECTLY ON THE SURFACE.KEEP AWAY FROM WATER AND DIRECT SUNLIGHT.STORE IN A DRY PLACE.FOR DOMESTIC USE ONLY.FOR INDOOR USE ONLY.A MILD ODOUR MAY BE PRESENT WHEN FIRST OPENING THIS CARTON.SIMPLY ALLOW TO AIR OUTSIDE AND THIS WILL FADE.



WARNING:

DO NOT STAND OR SIT ON THIS UNIT.DO NOT USE THIS UNIT UNLESS ALL BOLTS AND SCREWS ARE FIRMLY SECURED.DO NOT KNOCK OR DRAG THIS UNIT.USE ONLY ON A FLAT SURFACE.ADLT ASSEMBLY REQUIRED.FAILURE TO FOLLOW THESE WARNING COULD RESULT IN SERIOUS INJURY.LOAD DRAWER EVENLY TO PREVENT FROM TIPPING OVER.THIS PACKAGE CONTAINS SMALL PARTS AND SHARP POINTS.KEEP AWAY FROM CHILDREN AND BABIES.

MAXIMUM SAFE LOAD:15KGS FOR TOP PANEL,13KGS FOR BIG DRAWER,5KGS FOR SMALL DRAWER.

Hardware List



	a	6x35mm	54pcs
	b	15x9.5mm	54pcs
	c	6x30mm	50pcs

	d	4x30mm	36pcs
	e		22pcs
	f	4x12mm	2pcs

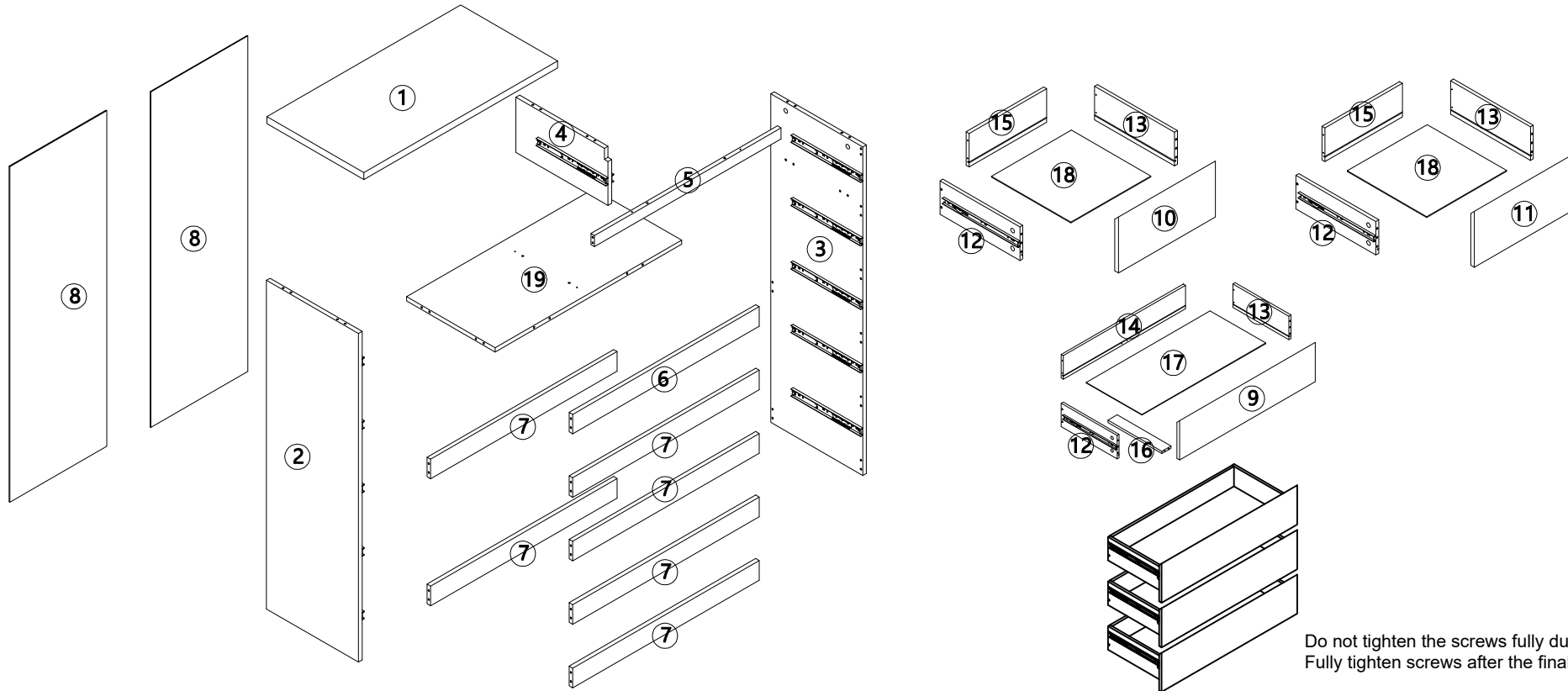

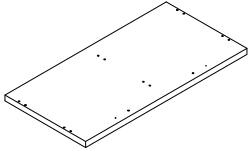
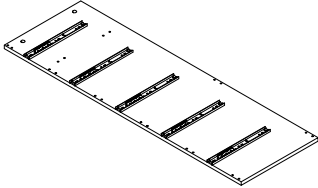
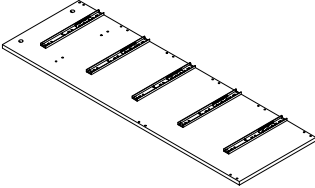
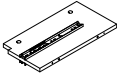
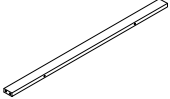
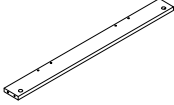
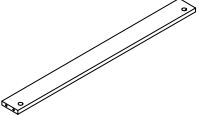
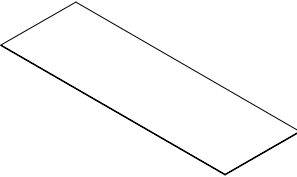
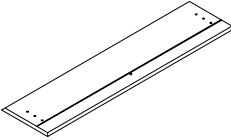
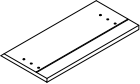
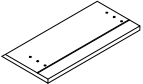
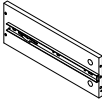
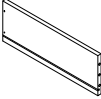
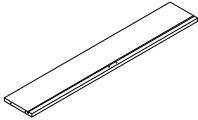
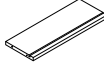

	g	4x35mm	2pcs
---	---	--------	------

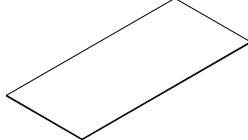
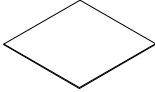
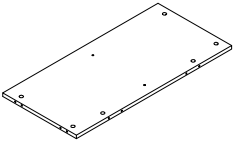

Do not tighten the screws fully during assembly.
Fully tighten screws after the final assembly steps.

					
① 1PC	② 1PC	③ 1PC	④ 1PC	⑤ 1PC	⑥ 1PC
					
⑦ 6PCS	⑧ 2PCS	⑨ 4PCS	⑩ 1PC	⑪ 1PC	⑫ 6PCS
					
⑬ 6PCS	⑭ 4PCS	⑮ 2PCS	⑯ 4PCS	⑰ 4PCS	⑱ 2PCS
					
⑲ 1PC					

Step 1:

 x 28  x 28  x 16  x 32

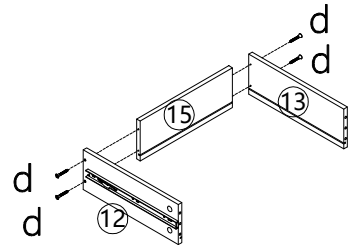

X 2

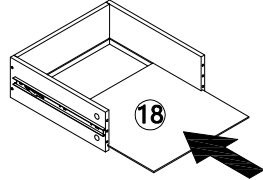

X 2

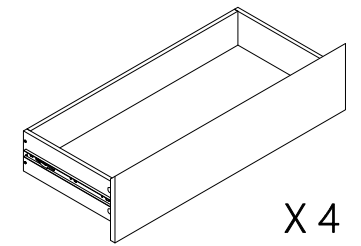
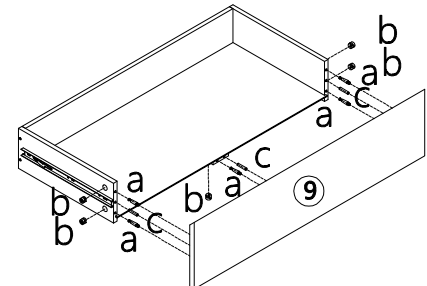
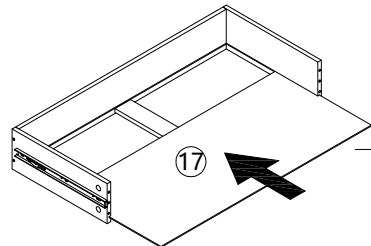
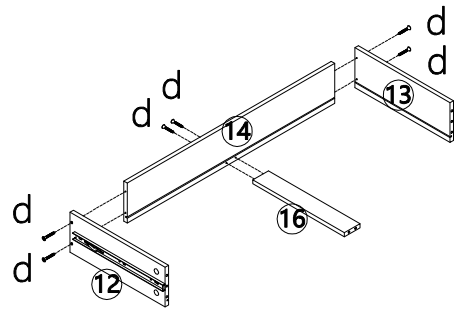
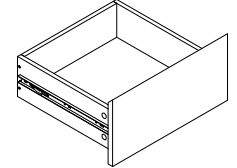
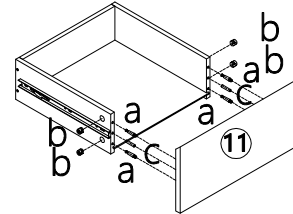
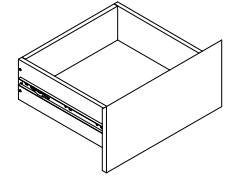
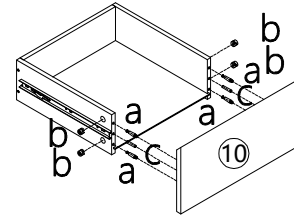

X 4

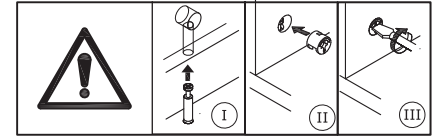
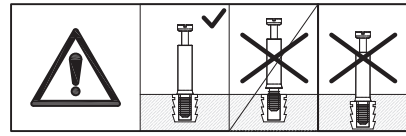

Step 2:

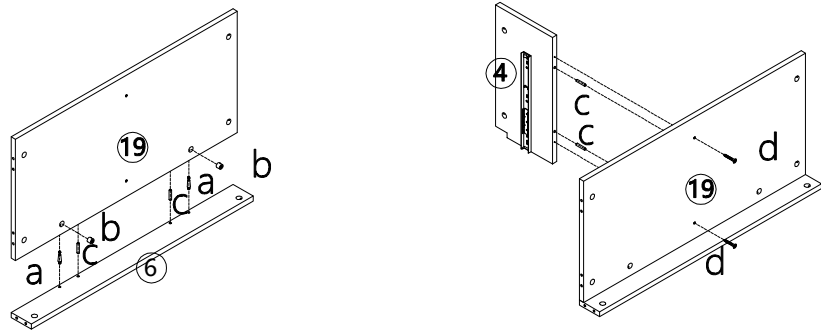
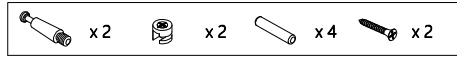

Step 3:

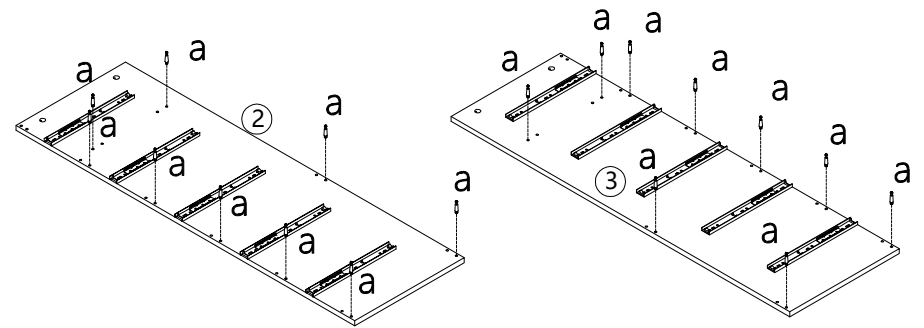
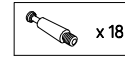

Step 4:

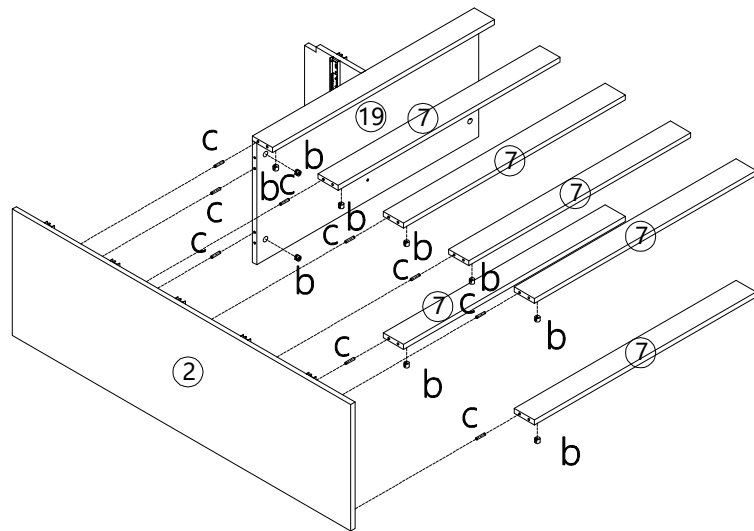
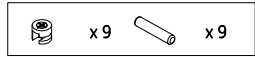

Step 5:

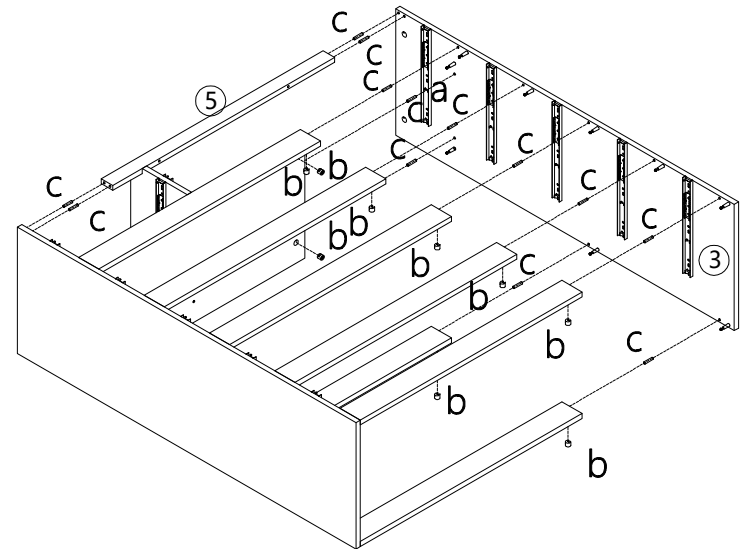
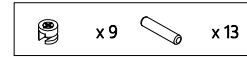

Step 6:

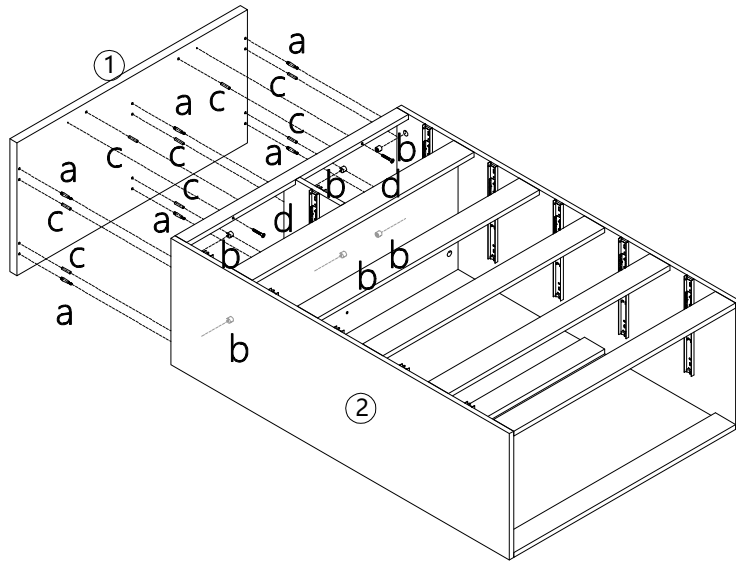
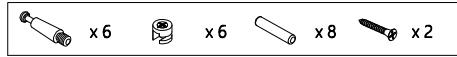

Step 7:

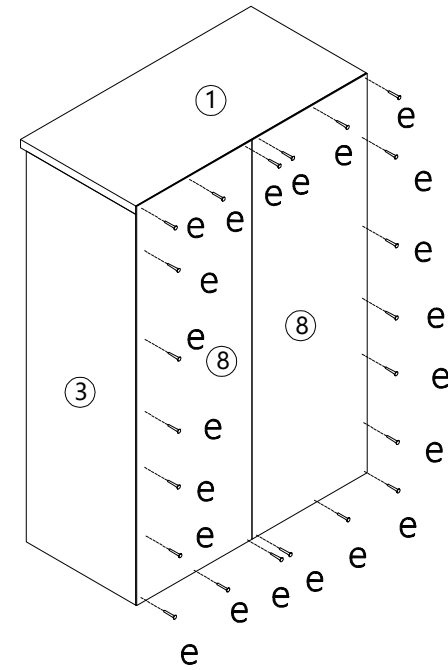

Step 8:

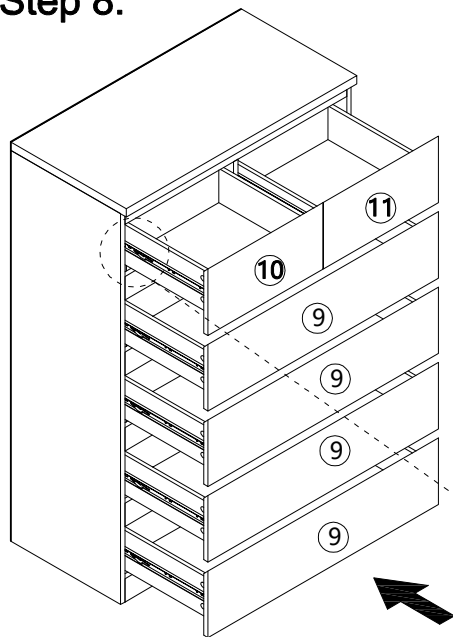

Slide ball bearing slide part to top of rail when assembling the drawer.

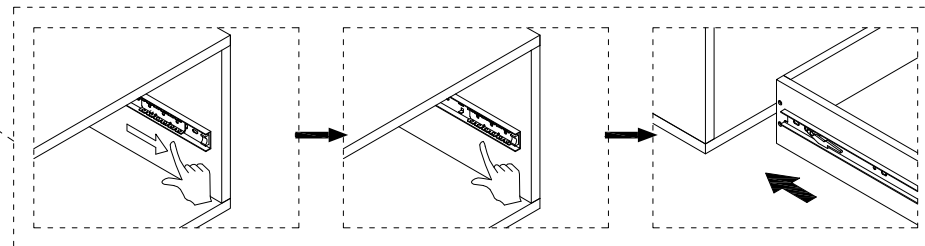

Step 9:

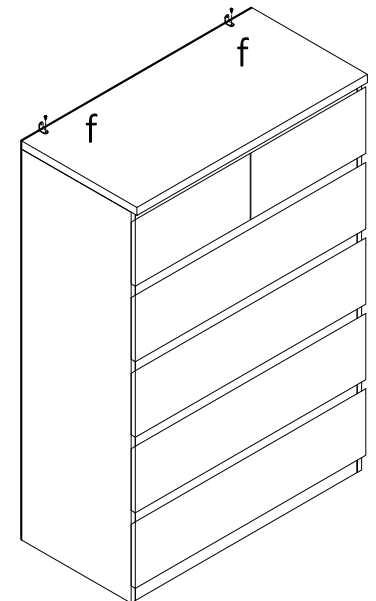
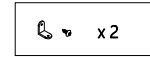

Step 10:  x2

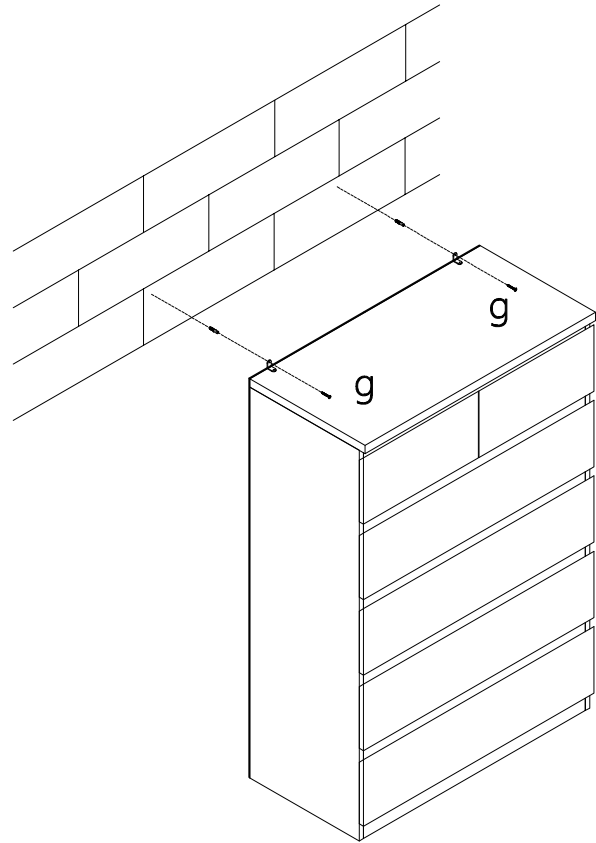

It is strongly recommended that this product is permanently fixed to the wall. Please seek professional advice if you are in doubt of what fixing device to use.

Regularly check that anchors are securely maintained.

CAUTION: for your safety when attaching the anchor fixings, please note the following: Check any electrical wires or plumbing inside the wall before drilling any holes

(if you are unsure please seek professional advice from a qualified tradesperson).

