

# Assembly Instruction

## 42942023 STEWART ENT UNIT

### CARE INSTRUCTIONS:







WIPE CLEAN WITH A DRY CLOTH. DO NOT USE ABRASIVE MATERIALS AND SOLVENTS. CHECK AND TIGHTEN ALL PARTS REGULARLY. DO NOT PLACE HOT ITEMS SUCH AS COFFEE CUPS DIRECTLY ON THE SURFACE. KEEP AWAY FROM WATER AND DIRECT SUNLIGHT. STORE IN A DRY PLACE. FOR DOMESTIC USE ONLY. FOR INDOOR USE ONLY. A MILD ODOUR MAY BE PRESENT WHEN FIRST OPENING THIS CARTON. SIMPLY ALLOW TO AIR OUTSIDE AND THIS WILL FADE.





### WARNING:

DO NOT STAND OR SIT ON THIS UNIT. DO NOT USE THIS UNIT UNLESS ALL BOLTS AND SCREWS ARE FIRMLY SECURED. DO NOT KNOCK OR DRAG THIS UNIT. USE ONLY ON A FLAT SURFACE. ADULT ASSEMBLY REQUIRED. FAILURE TO FOLLOW THESE WARNING COULD RESULT IN SERIOUS INJURY. THIS PACKAGE CONTAINS SMALL PARTS AND SHARP POINTS. KEEP AWAY FROM CHILDREN AND BABIES.

**MAXIMUM SAFE LOAD: 25KGS FOR TOP PANEL, 5KGS FOR EACH LAYER.**



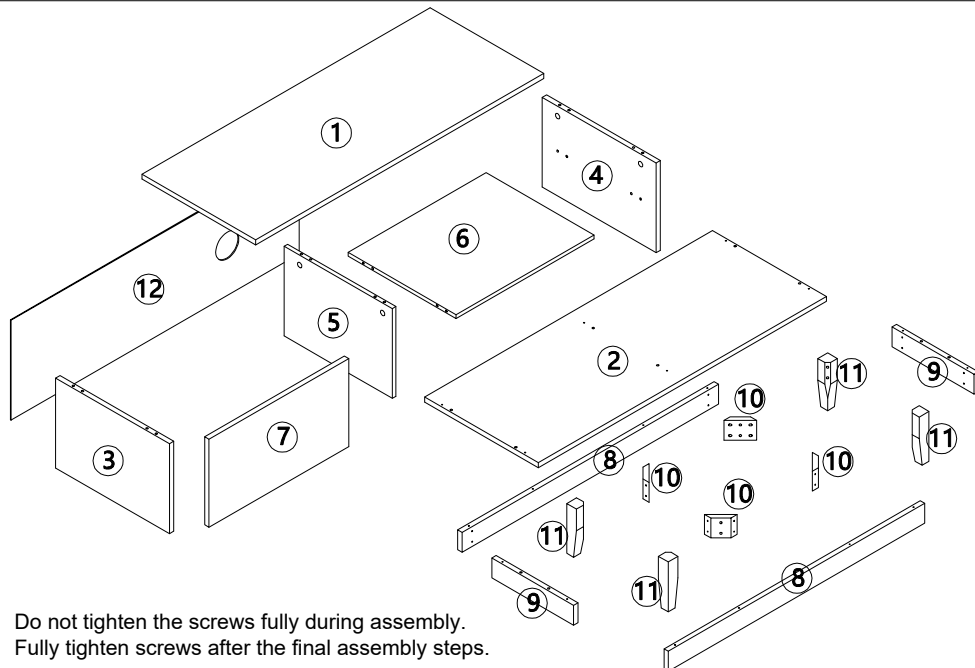

## Hardware List

	a	6x35mm	10pcs
	b	15x9.5mm	10pcs
	c	6x30mm	24pcs
	d	4x35mm	6pcs
	e		2pcs
	f	4x14mm	12pcs
	g		12pcs

	h	4x55mm	12pcs
	i	4x25mm	16pcs
	j	6x55mm	8pcs
	k		1pc
	l	4x12mm	2pcs

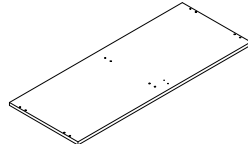
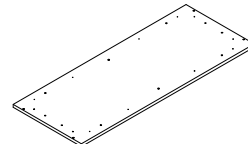
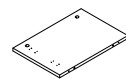
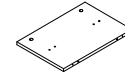
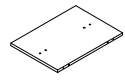
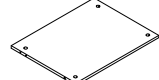
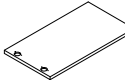
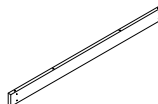

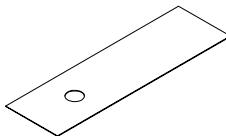

Do not tighten the screws fully during assembly.  
Fully tighten screws after the final assembly steps.

	①	1PC		②	1PC		③	1PC
	④	1PC		⑤	1PC		⑥	1PC
	⑦	1PC		⑧	2PCS		⑨	2PCS
	⑩	4PCS		⑪	4PCS		⑫	1PC

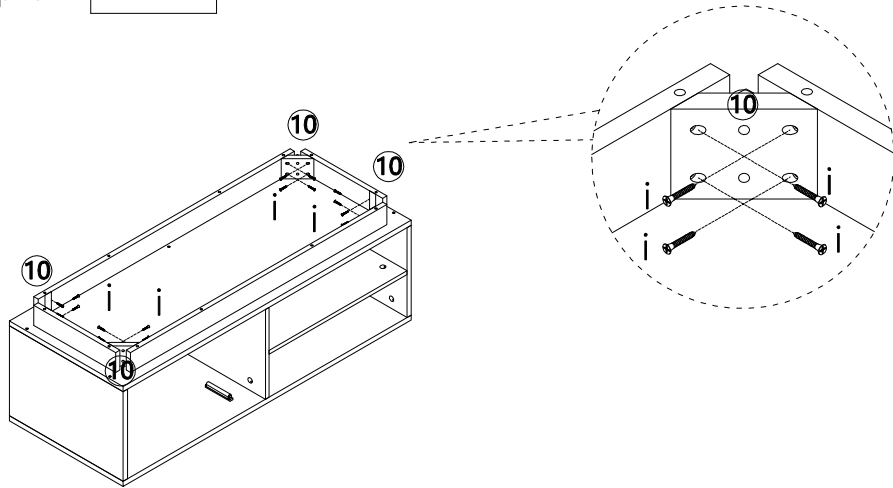

Step 5:  x16



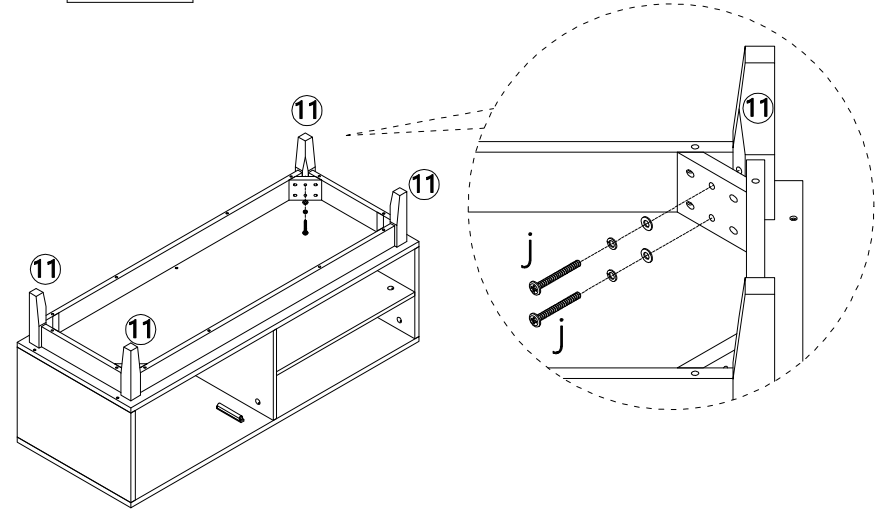

Step 6:  x8

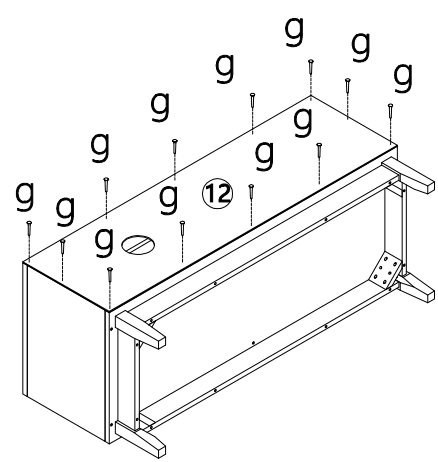

Step 7:  x12



Step 8:  x2  x12

