



# britax

## safe·n·sound

### CONVERTIBLE CAR SEAT

WITH OPTIONAL ISOFIX COMPATIBILITY  
Suitable for Birth to 4 years (approx)

Instructions for Installation & Use



#### REARWARD FACING

Birth to 2-3  
years (approx)



#### FORWARD FACING

12 months to  
4 years (approx)

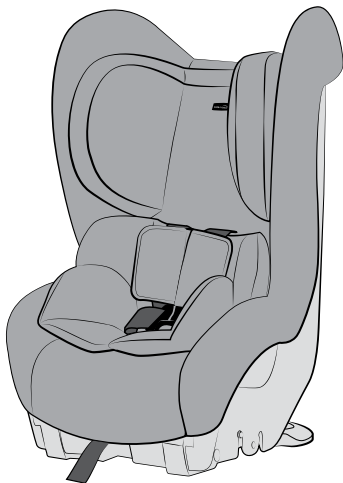

Series No. BS0072E-i20133  
Series No. BS0072E-020133  
Series No. BS0072K-020133

**ISOFIX**  
COMPATIBLE

If you have purchased an  
ISOFIX compatible version  
then ISOFIX compatible  
straps are fitted to the seat.



**IMPORTANT:**

**KEEP THIS BOOKLET IN THE PLACE PROVIDED ON THE CHILD RESTRAINT**

# SEATBELT QUICK SETUP REARWARD FACING

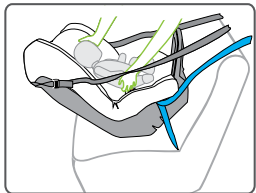
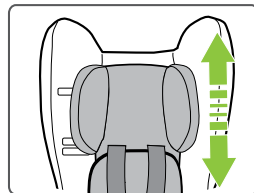
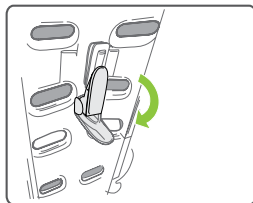
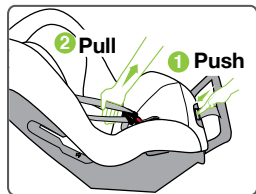
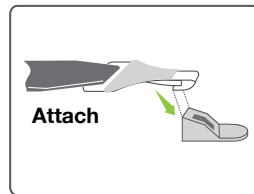
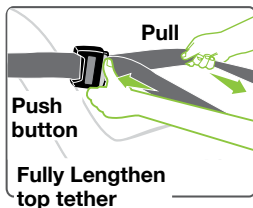
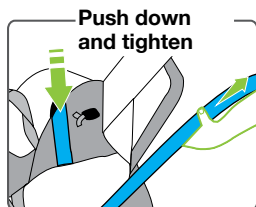
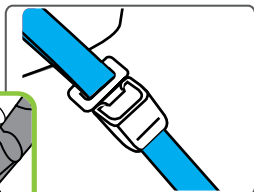
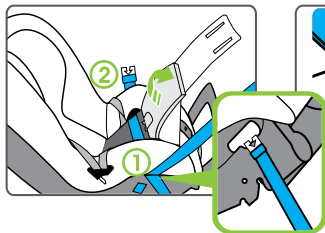
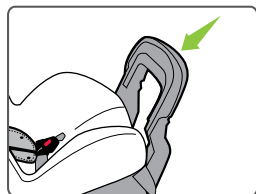
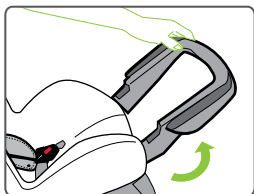
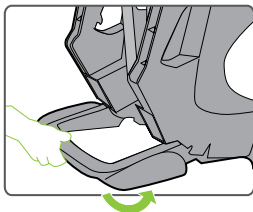

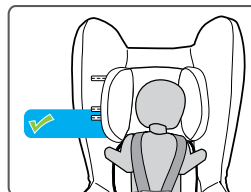
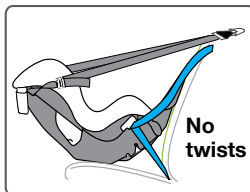
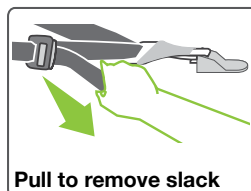
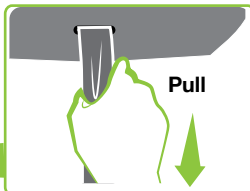
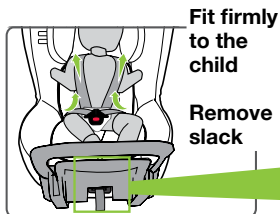
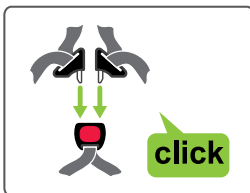
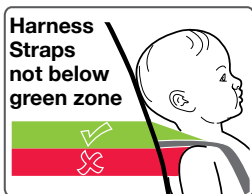

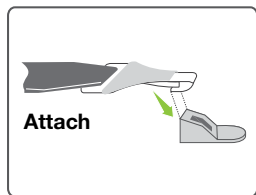
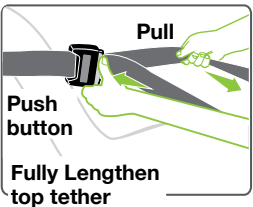
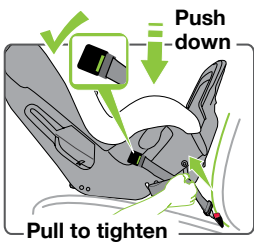
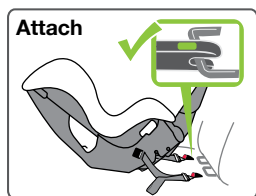
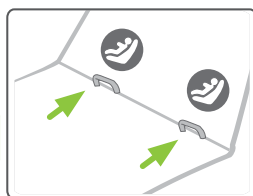
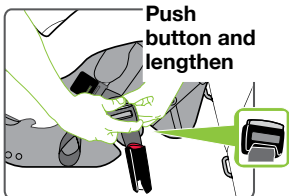
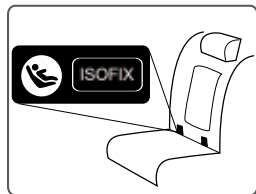
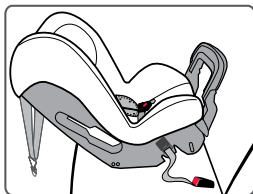
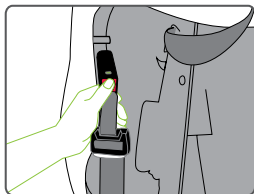
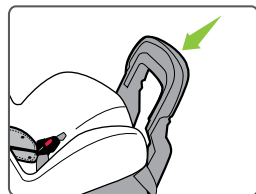
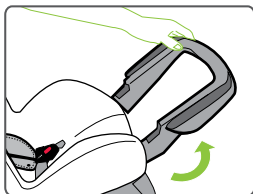
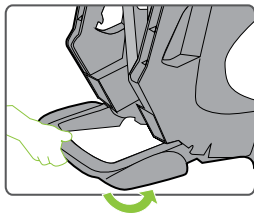

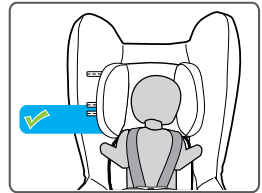
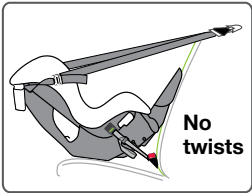
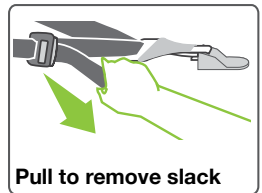
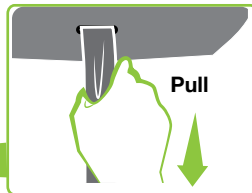
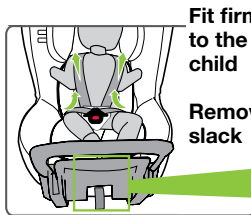
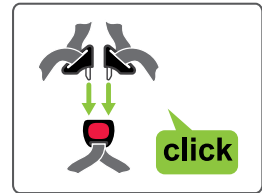
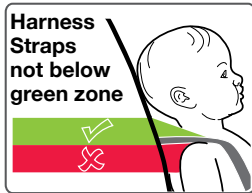
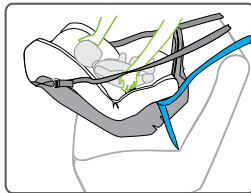
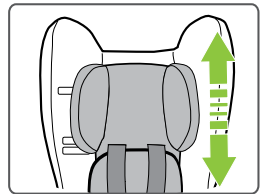
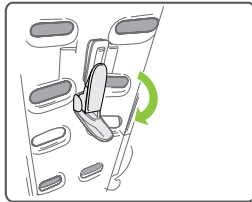
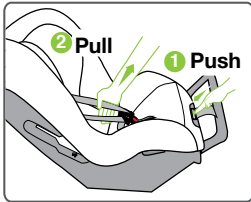

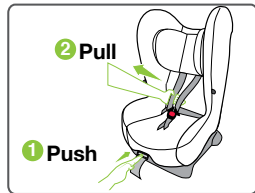
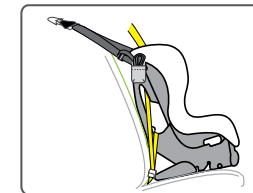
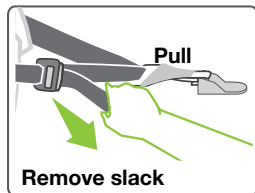
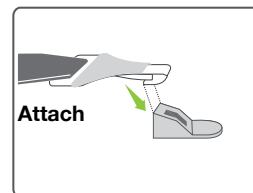
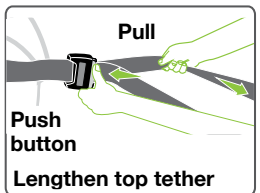
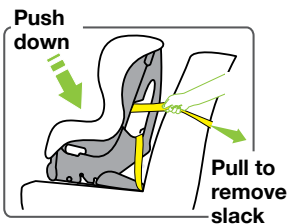
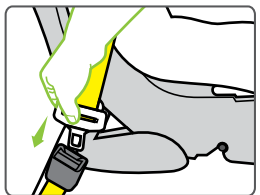
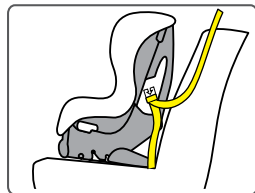
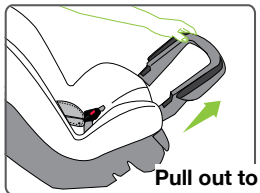

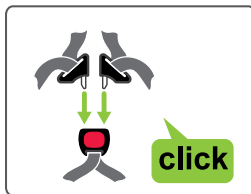
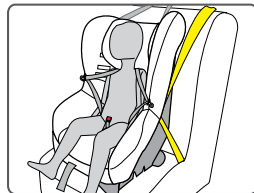
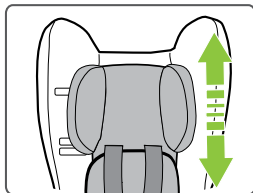
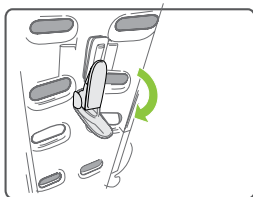

**Fit firmly to the child**

**Remove slack**

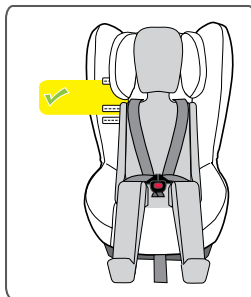
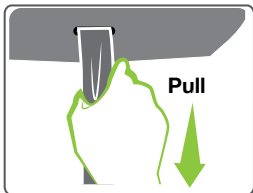
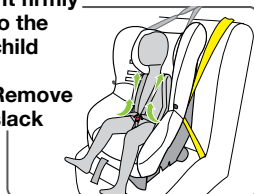

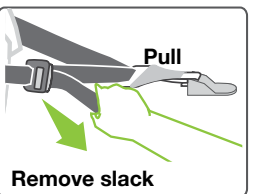
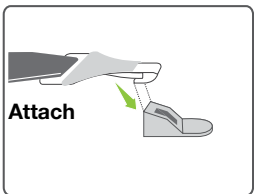
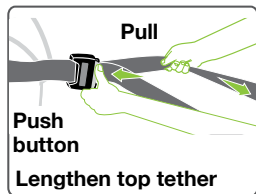
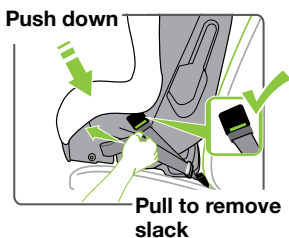
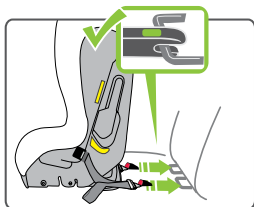
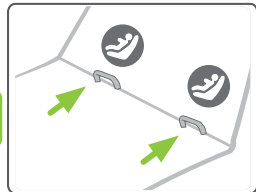
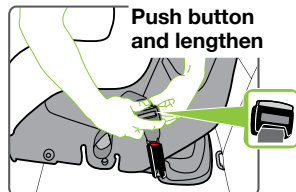
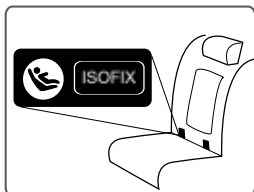
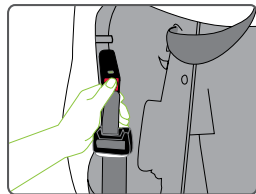
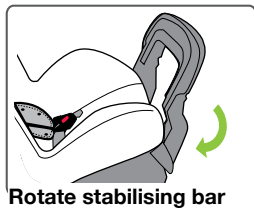
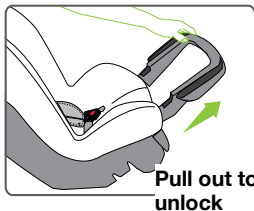



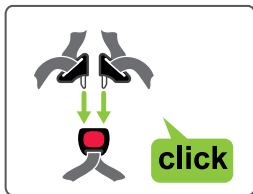
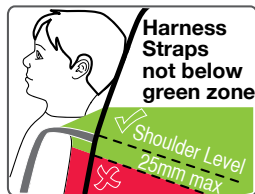
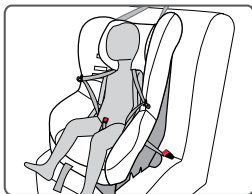
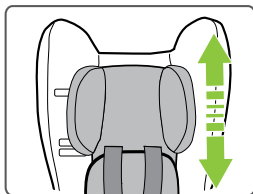
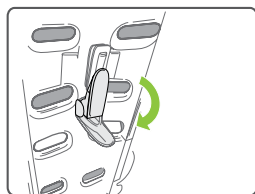
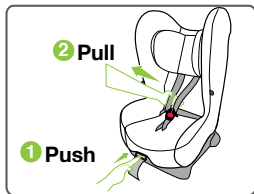
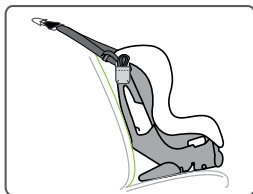

Fit firmly  
to the  
child

Remove  
slack

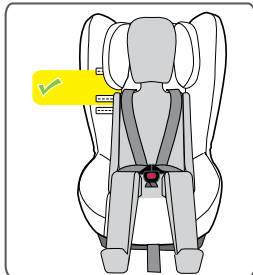
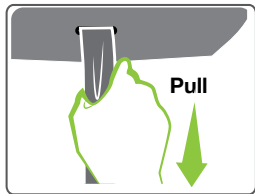
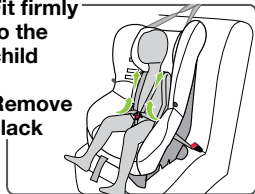

To be used only in a rearward-facing position until the infants's shoulders either reach the lower shoulder height marker (approximately 12 months of age) or reach the middle height marker (approximately 2 to 3 years of age). Then to be used in a forward-facing position until the child's shoulders reach the upper shoulder height marker (approximately 4 years of age).

Continue to use this child restraint until the child reaches this limit.

Do not use forward facing until child's shoulders are above the lower shoulder height marker.

Infants are at risk of serious injury if they face forward too early.

Children are at risk of serious injury if they move to booster seats too early.

Children who have outgrown this restraint are safest in a larger child restraint with an in-built harness or a booster seat until their shoulders reach the upper shoulder height marker of the restraint.

للاستخدام فقط في الوضعية المواجهة للخلف، حتى يصل كتفا الطفل إما إلى الإشارة السفلية لارتفاع الكتف (حوالي 12 شهرا من العمر) أو إلى الإشارة المتوسطة لارتفاع الكتف (حوالي 2-3 سنوات من العمر). ثم الاستخدام في الوضعية (المواجهة للأمام حتى يصل كتفا الطفل إلى الإشارة العلوية لارتفاع الكتف) (حوالي 4 سنوات من العمر). استمر في استخدام حاجز الأطفال هذا لحين وصول الطفل إلى هذا الحد. لا تستخدم الوضعية المواجهة إلى الأمام إلا عندما يكون كتفي الطفل أعلى من علامة ارتفاع الأكتاف السفلية. يكون الرضع في مخاطرة للتعرض إلى الإصابات الخطيرة إذا تم توجيههم إلى الأمام بصورة مبكرة أكثر من اللازم. يكون الأطفال في مخاطرة للتعرض إلى الإصابات الخطيرة إذا ما انتقلوا إلى مقاعد الأمان المرتفعة بصورة مبكرة أكثر من اللازم.

يكون الأطفال الذين كُبر حجمهم عن هذا الحاجز أكثر أماناً في حاجز أطفال ذو مقاس أكبر ومزود بأحزمة مدمجة أو مقعد أمان مرتفع حتى تصل أكتافهم إلى علامة ارتفاع الأكتاف العلوية للحاجز.

只用于后向式安装，直到婴儿的肩膀达到靠下的肩高标记（大约12个月的宝宝）或者中部的肩高标记（大约2-3岁的儿童）。然后用于前向式安装，直到儿童的肩膀达到靠上的肩高标记（大约4岁的儿童）。

在儿童达到该座椅上限以前必须不断使用这一安全座椅。

在儿童肩高未超过靠下的肩高标记之前不得采用前向式坐姿。

婴儿过早乘坐前向式座椅则可能受到严重的伤害。

儿童过早使用垫高椅则可能受到严重的伤害。

个子比该安全座椅大的儿童最安全的做法是乘坐设有内置安全带的更大汽车座椅或垫高椅，直到他们的肩膀达到该座椅靠上的肩高标记。

Magagamit lamang sa isang nakaharap sa likod na posisyon hanggang sa maabot ng balikat ng sanggol ang alinman sa ibabang marka ng taas ng balikat (humigit-kumulang 12 na buwang edad) o maabot ang panggitnang marka ng taas (humigit-kumulang 2-3 taong edad). Pagkatapos ay magagamit sa nakaharap sa unahan na posisyon hanggang sa maabot ng mga balikat ng bata ang itaas na marka ng taas sa balikat (humigit-kumulang 4 na taong edad).

Ipagpatuloy ang paggamit ng pampigil ng bata na ito hanggang sa maabot ng bata ang limitasyong ito.

Huwag gamitin sa isang nakaharap sa unahan na posisyon hanggang sa malampasan ng mga balikat ng bata ang ibabang marka ng taas ng balikat

Ang mga sanggol ay nasa seryosong peligro ng pagkapinsala kung sila ay haharap ng masyadong maaga.

Ang mga bata ay nasa seryosong peligro ng pagkapinsala kung sila ay masyadong maagang ililipat sa mga upuang booster.

Ang mga batang napagkalakhan na ang pampigil na ito ay pinakaligtas sa isang mas malaking pampigil sa bata na may kasamang guwarnisyon o isang upuang booster hanggang sa maabot ng kanilang mga balikat ang itaas na marka ng taas ng balikat ng pampigil.

Sólo debe utilizarse orientado hacia atrás hasta que los hombros del niño alcancen el marcador de altura inferior (aproximadamente a los 12 meses de edad) o alcancen el marcador de altura medio (aproximadamente de 2 a 3 años de edad). Posteriormente debe utilizarse orientado hacia adelante hasta que los hombros del niño alcancen el marcador de altura superior (aproximadamente a los 4 años de edad).

Utilice este sistema de seguridad infantil hasta que el niño alcance ese límite.

No utilice la silla orientada hacia adelante hasta que los hombros no sobrepasen el marcador de altura inferior.

El niño corre el riesgo de sufrir lesiones graves si se utiliza la silla orientada hacia adelante antes de tiempo.

El niño corre el riesgo de sufrir lesiones graves si se lo traslada antes de tiempo a un asiento elevador.

El niño que ya no quepa en este sistema de seguridad estará más seguro en un asiento para niños más grande con un arnés incorporado o un asiento elevador hasta que sus hombros alcancen el marcador de altura superior del sistema de seguridad.

Να χρησιμοποιείται μόνο σε θέση στραμμένο προς τα πίσω μέχρι οι ώμοι του βρέφους είτε να φτάνουν στον κάτω δείκτη ύψους ώμου (περίπου 12 μηνών) είτε να φτάνουν στον μεσαίο δείκτη ύψους (περίπου 2 με 3 ετών). Κατόπιν να χρησιμοποιούνται σε θέση που να κοιτάζει προς τα εμπρός μέχρι οι ώμοι του παιδιού να φτάνουν στον επάνω δείκτη ύψους ώμου (περίπου 4 ετών).

Συνεχίστε να χρησιμοποιείτε αυτό το σύστημα συγκράτησης βρεφών μέχρι το παιδί να φτάσει σε αυτό το όριο.

Μην το χρησιμοποιείτε στραμμένο προς τα εμπρός μέχρι οι ώμοι του παιδιού να είναι πάνω από τον χαμηλότερο δείκτη ύψους ώμων.

Τα νήπια κινδυνεύουν με σοβαρό τραυματισμό αν κοιτάζουν προς τα εμπρός πολύ χωρίς.

Τα παιδιά διατρέχουν κίνδυνο σοβαρού τραυματισμού, εάν μετακινηθούν σε βοηθητικά

Da utilizzare solo in posizione rivolta all'indietro fino a quando le spalle del bambino raggiungono il marcatore di altezza inferiore della spalla (circa 12 mesi di età) o il marcatore di altezza centrale (circa 2 o 3 anni). Dopo di che, può essere usato nel senso di marcia fino a quando le spalle del bambino raggiungono il marcatore di altezza della spalla superiore (circa 4 anni di età).

Continuare a utilizzare questo sistema di ritenuta del bambino fino a quando raggiunge questo limite.

Non utilizzare nel senso di marcia fino a quando le spalle del bambino superano il marcatore di altezza inferiore.

I neonati sono a rischio di lesioni gravi se messi in posizione frontale troppo presto.

I bambini sono a rischio di lesioni gravi se si muovono dal seggiolino troppo presto.

I bambini che hanno superato la marcatura sono più sicuri in un sistema di ritenuta per bambini più grande con imbracatura interna o in un seggiolino fino a quando le spalle raggiungono il marcatore di altezza superiore della spalla del sistema di ritenuta.

केवल पीछे की तरफ मुँह किये हुये स्थिति में तब तक प्रयोग करें जबतक या तो शिशु का कन्धा कन्धे के नचिले भाग के चनिह तक न पहुँच जाए (लगभग 12 महीने की आयु पर) या फरि मध्य भाग के चनिह तक न पहुँच जाए (लगभग 2 से 3 वर्ष की आयु पर)। इसके बाद शिशु का मुँह सामने की दशा में हो जबतक शिशु का कन्धा कन्धे के ऊपरी भाग के चनिह तक न पहुँच जाए (लगभग 4 साल की आयु पर)।

शिशु के इस सीमा तक पहुँचने तक इस शिशु प्रतबिन्ध का प्रयोग जारी रखें।

शिशु के मुँह सामने की दशा की ओर तब तक न करें जबतक कि शिशु का कन्धा कन्धे के नचिले भाग के चनिह को पार न करें।

शिशुओं को समय से पहले सामने की ओर बैठाए जाने पर उन्हें गम्भीर चोट का खतरा होता है।

बूस्टर सीट को समय से पहले प्रयोग किए जाने पर शिशुओं को गम्भीर चोट का खतरा होता है।

जो शिशु इस प्रतबिन्ध के लिए अनुकूल आयु से बड़े हो चुके हों, वे एक बड़े आकार के प्रतबिन्ध में सबसे अधिक सुरक्षित होते हैं

जिसकी इन-बलिट हार्नस या बूस्टर सीट हो और तब तक जब तक उनके कन्धे प्रतबिन्ध के कन्धे के ऊपरी भाग के चनिह तक न पहुँच जाए।

僅可後向安裝使用，直至嬰兒肩膀達到靠下的肩高標記（大約12個月大），或是達到中間肩高標記（大約2至3歲大）。然後您才能讓其乘坐前向安裝使用的座椅，直至其肩膀達到高位肩膀高度標記（大約4歲大）。

孩子應一直採用後向式坐姿，直至其達到後向式坐姿的上限。

孩子肩膀未超過靠下的肩高標記前，切勿採用前向式坐姿。

孩子若過早乘坐前向式汽車座椅，可能會對其造成嚴重的傷害。

急於讓孩子過早地乘坐墊高椅，可能會對其造成嚴重的傷害。

孩子因長大超出此汽車座椅的上限，最安全的做法便是採用更大且有內建式安全帶的汽車座椅，或是乘坐墊高椅，直至其肩膀達到汽車座椅靠上的肩高標記。

Chỉ được sử dụng ở vị trí hướng mặt về phía sau cho đến khi vai của bé cao tới vạch ghi ở dưới cùng (khoảng 12 tháng tuổi) hay tới vạch ghi độ cao ở giữa (khoảng 2 tuổi tới 3 tuổi). Sau đó được sử dụng hướng mặt về phía trước đến khi vai của em cao tới vạch ghi ở trên cùng (khoảng 4 tuổi).

Hãy tiếp tục sử dụng ghế em bé này đến khi em cao tới giới hạn này.

Không sử dụng hướng mặt về phía trước cho đến khi vai của em bé trên vạch ghi độ cao của vai ở dưới cùng.

Bé sơ sinh có nguy cơ bị chấn thương nghiêm trọng nếu hướng mặt về phía trước quá sớm.

Trẻ em có nguy cơ bị chấn thương nghiêm trọng đối sang ghế em bé (booster) quá sớm.

Các em nào lớn hơn ghế em bé được an toàn nhất là trong ghế em bé (restraint) lớn hơn với đai nịt gắn sẵn hoặc ghế trẻ em rộng hơn cho đến khi vai của em cao tới vạch ghi độ cao của vai ở trên cùng của ghế em bé.

These instructions cover various configurations of this model. To determine if the feature is available on your child restraint refer to packaging. ISOFIX compatible connection is not available on all models. To be used with a lap-sash or lap only seatbelt or ISOFIX low anchorages (if supplied) in the back of most cars with forward facing seats.

The child should not sit in this restraint in the forward facing mode until their neck muscles are able to support their head. Britax recommends that you keep your child in a rearward facing restraint for as long as possible (or until the appropriate shoulder height marker is reached between 12 months and 2yrs approx).

No child restraint can guarantee absolute protection from injury in every crash. However, to ensure that your child gets all the protection designed into the restraint PLEASE READ AND FOLLOW THESE INSTRUCTIONS EXACTLY and use only Britax Safe-n-Sound recommended parts and accessories.

If in doubt about the method of installation, consult Britax Childcare or agent, or a child restraint fitter or, in New Zealand, to consult the agent for the vehicle.

Regional Road Rules may prohibit the use of this restraint in the front seat of the car until the child is 4 years of age. Check your Regional Rules for exemptions.

Note: These instructions show the adjustable headrest with side wings. **Always store the instruction book in the pocket provided and tuck pocket under trim cover.**

**ISOFIX**  
COMPATIBLE

Your seat might also feature ISOFIX Compatible Connectors. There will be straps fitted to each side of the lower part of the seat. Britax flexible strap ISOFIX Compatible connector technology is known as ISOFLEX.



#### WHAT ARE ISOFIX LOW ANCHORAGES IN A VEHICLE?

ISOFIX low anchorages are fixed, standardised anchoring points for securely installing an ISOFIX compatible child restraint in a vehicle fitted with ISOFIX low anchorages. They are an alternative method of installing the child restraint without using the car's seatbelt.

ISOFIX is an international standard for vehicle child seat anchorages.

This anchoring technology minimises installation mistakes by optimising the protective effect of the connection between vehicle and ISOFIX compatible child restraint.

Consult the car owner's handbook for location of top tether anchorage points.

An available anchor point is required to attach the top tether strap onto. The top tether strap must be used with this child restraint when used in a road vehicle.

If there is no child restraint anchor fitting or child restraint anchor point refer to pages 85 to 88 for the installation of the anchor fitting as well as the use of extension straps.

Select a seating position with a child restraint anchor fitting directly behind the seating position.

Determine if the vehicle ISOFIX Low Anchorages or Seatbelt will be used to secure the restraint installation. The ISOFLEX connectors will need to be deployed from their storage location prior to adjusting the seat recline angle to rearward facing mode.

### **ISOFIX COMPATIBLE WITH TOP TETHER STRAP**

- If supplied with ISOFIX compatible straps the installation may be either seatbelt and top tether strap or ISOFLEX Connectors and top tether strap.

For Rearward Facing Use - Refer to page 35 to 41

For Forward Facing Use - Refer to page 62 to 65

### **SEAT BELT WITH TOP TETHER STRAP**

- If not supplied with ISOFIX compatible straps this seat is suitable for fitting with seatbelt and top tether strap.

Use your vehicle seat belt and top tether strap to install this seat. Follow the directions outlined:

For Rearward Facing Use - Refer to page 28 to 34

For Forward Facing Use - Refer to page 56 to 61

- 18 IMPORTANT INFORMATION AND WARNINGS
- 20 SHOULDER HEIGHT MARKERS
- 22 SHOULDER HEIGHT MARKERS A GROWING CHILD
- 23 SHOULDER HEIGHT MARKERS THE NEXT STEP

## REARWARD FACING

- 24 FEATURES: REARWARD-FACING
- 27 SUITABLE FOR USE
- 28 HOW TO INSTALL PREPARATION
- 29 HOW TO INSTALL USING SEATBELT
- 35 HOW TO INSTALL USING ISOFLEX CONNECTORS
- 42 HOW TO USE
- 49 HOW TO REMOVE



**FORWARD FACING**

- 52 FEATURES: FORWARD-FACING
- 55 SUITABLE FOR USE
- 56 HOW TO SETUP
- 58 HOW TO INSTALL USING SEATBELT
- 62 HOW TO INSTALL USING ISOFLEX CONNECTORS
- 66 HOW TO USE
- 71 HOW TO REMOVE

**AIRCRAFT USE**

- 74 HOW TO INSTALL IN AN AIRCRAFT

**CARE & MAINTENANCE**

- 77 CARE & MAINTENANCE
- 82 ACCESSORIES
- 85 INSTALLATION OF CAR'S UPPER ANCHORAGE POINT
- 89 TRAVELLING TIPS
- 91 IN CASE OF ACCIDENT
- 92 WARRANTY

**WARNINGS**

- Fit the restraint firmly to the car seat.
- Fit the harness firmly to the child.
- A loose restraint or harness is dangerous.
- Supervision of children is needed because they may be able to undo the buckles and adjusters.
- Use the restraint exactly as shown in the instructions.
- **DO NOT LEAVE CHILDREN UNATTENDED IN THE CAR.**
- Do not alter or modify this restraint.
- Repairs must only be done by the manufacturer or agent.
- Do not allow the restraint to come into contact with polishes, oils, bleach and other chemicals.
- Destroy the restraint if it has been in a severe crash, even if no damage is visible. See page 77.
- **DO NOT USE THIS RESTRAINT WITHOUT THE COVER.**
- Always secure the loose end of the top tether strap. Do not use the child restraint where this strap may fall into a split in the seat back or off the side of the seat.
- **ALWAYS ATTACH HOOK AND REMOVE SLACK.**
- To ensure infant's back is evenly supported, do not put more than one nappy on the baby and make sure the nappy is not thickly folded at the back.
- **DO NOT USE A REAR-FACING CHILD RESTRAINT WHERE AN AIRBAG IS FITTED IN FRONT OF THE SEATING POSITION.**
- Do not harness an infant wrapped in a blanket or swaddled. Any blanket or wrap must only be placed over the harness and infant.

**IMPORTANT :****NON ISOFIX COMPATIBLE: FOR INSTALLATION WITH SEATBELT ONLY:**

- TO BE USED WITH A LAP-SASH OR LAP ONLY SEATBELT IN THE BACK OF MOST CARS WITH FORWARD FACING SEATS.
- Without ISOFIX compatible connectors; This child restraint is not approved for use with any connectors that connect to the car's ISOFIX low anchorages.

**ISOFIX COMPATIBLE: FOR INSTALLATION WITH ISOFLEX CONNECTORS:**

- TO BE USED WITH A LAP-SASH OR LAP-ONLY SEATBELT OR ISOFIX LOW ANCHORAGES IN THE BACK OF MOST CARS WITH FORWARD FACING SEATS.
- Do not attach the lower attachment connectors of two separate child restraints to the same ISOFIX low anchorages in your car.
- Always attach the top tether strap to the child restraint upper anchorage in your car.
- Child restraint lower attachment connectors and the ISOFIX low anchorages in your car are designed to withstand only those loads imposed by a correctly fitted child restraint.

**GENERAL**

- Regularly check the restraint components, straps and other fitments for correct function and condition. If faulty, cease using and seek repair by Britax.
- IF AN AIRBAG IS FITTED IN THE SEATING POSITION WHERE THE CHILD RESTRAINT IS TO BE FITTED, FOLLOW THE VEHICLE MANUFACTURERS WARNINGS AND INSTRUCTIONS.
- Protect all webbing from abrasion and cutting by sharp corners and edges.
- The restraint should not be purchased or sold as a second hand item. It is recommended not to use child restraints older than 10 years as the protection in an accident may be reduced.
- THIS RESTRAINT IS NOT SUITABLE FOR USE WHERE THE TOP TETHER STRAP MAY FALL INTO A SPLIT IN THE SEAT BACK OR OFF THE SIDE OF THE SEAT.
- Seatbelt extenders are not recommended to be used if the seatbelt is not long enough to secure the child restraint. If seatbelts are too short then seek advice from a child restraint fitter and consider their recommendations before using a seatbelt extender. If you use a seatbelt extender then ensure that the seatbelt buckle does not enter the rearward or forward facing belt paths.
- THIS RESTRAINT MUST BE ATTACHED TO A CHILD RESTRAINT UPPER ANCHORAGE POINT IN THE CAR. REFER TO CAR OWNER'S HANDBOOK FOR LOCATION OF UPPER ANCHORAGE POINTS. REFER TO A CHILD RESTRAINT FITTING STATION IF NO UPPER ANCHORAGE POINTS ARE IN THE MOTOR CAR. Refer to pages 85 to 88.

 **IMPORTANT: Follow this advice.**

### Marker A: LOWER SHOULDER HEIGHT MARKER

When the child's shoulders reach the lower marker, the child restraint may be turned to face towards the front of the vehicle Britax recommends to maintain rearward facing while the infant can be accommodated comfortably or until the shoulders reach marker B.

At least 12 months of age.

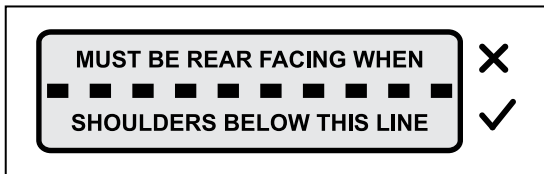

### Marker B: MIDDLE SHOULDER HEIGHT MARKER

When the child's shoulders reach this marker, the seat must be converted into forward facing mode.

Approximately 2 to 3 years of age.

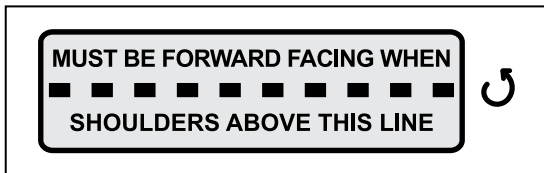

### Marker C: UPPER SHOULDER HEIGHT MARKER

When the child's shoulders reach this upper marker, the child is now too big for the child restraint. It is now time to move to the next child restraint type.

Approximately 4 years of age.

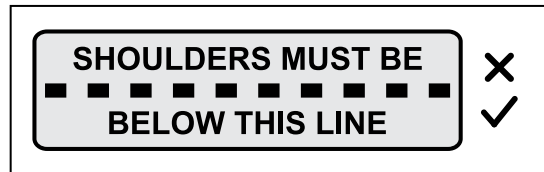

This child restraint is unsuitable for an occupant whose shoulders are above the upper height marker. The child needs to be moved into the next form of child restraint.

This restraint is suitable for a newborn and must remain rear facing until the child reaches the lower shoulder height marker (approx. 12 months old).

Once the child reaches the lower shoulder height marker the restraint can either;

- Remain rear facing while the shoulders are in the **mid-zone** until the middle shoulder height marker is reached, or
- Change the mode to forward facing until the upper shoulder height marker is reached (approx 2 to 3 years).
- Britax recommends that you keep your child in a rearward facing restraint for as long as possible until the middle shoulder height marker is reached or child becomes uncomfortable.

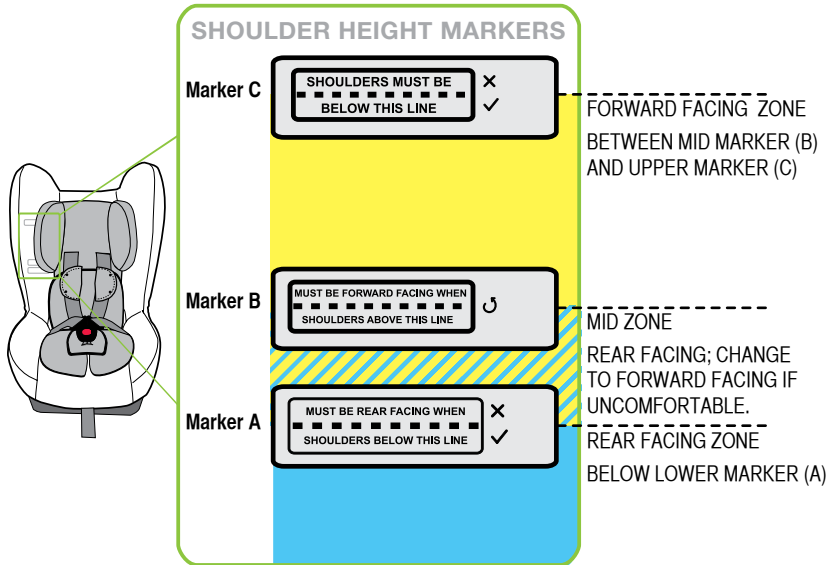

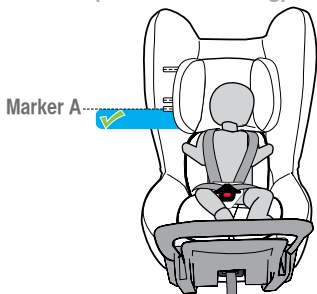
**REARWARD FACING** (Suitable up to 30mths approx)**Newborn (Rearward Facing)**

Rear facing mode is suitable for shoulders below the Lower Height Marker (A)

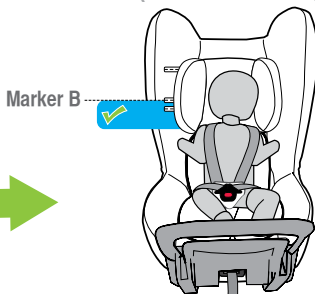
**Older Child (Rearward Facing)**

While below marker B, remain rearward facing. Convert to forward facing when shoulder height Marker (B) is reached.

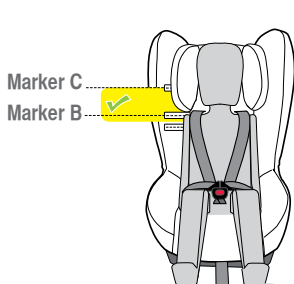
**FORWARD FACING** (Suitable from 12mths to 4 yrs approx)**Child Use (Forward Facing)**

Forward-facing mode is suitable for shoulders above shoulder height marker B but not below marker A.

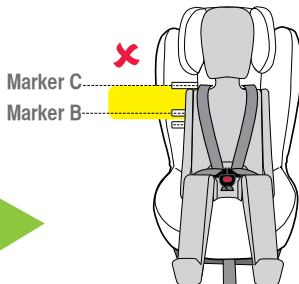
**Discontinue Use (Forward Facing)**

Move to the next form of child restraint when the child's shoulders reach the upper shoulder height marker C.



**A loose restraint or harness is dangerous. Always remove slack from all webbing straps.**

## WHICH RESTRAINT CAN YOU USE NEXT?

When your child has outgrown the seat, you can:

- A. Use a booster seat suitable for children up to 8-10 years of age with the car's seatbelt.\*
- B. A child may use the vehicle seat and seatbelt

### OR

without a booster seat if the child's legs hang over the seat edge.

Otherwise if the child's legs do not hang over the edge of the vehicle seat then they need to use a booster seat so that the seatbelt fits correctly and so the child does not slump.

A lap seatbelt on the child's abdomen is dangerous.

NOTE: This child restraint includes a booster seat configuration for children 4 years to approximately 6 to 8 years.

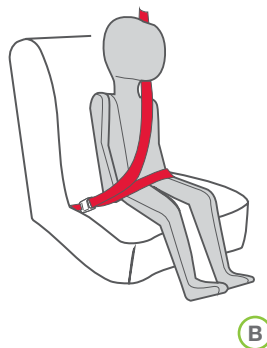
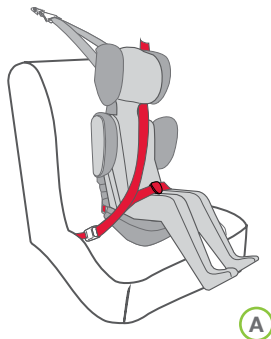

\*For more information on suitable booster seats visit [www.babylove.com.au](http://www.babylove.com.au) or [www.britax.com.au](http://www.britax.com.au)

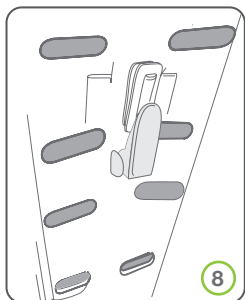

(Harness strap not shown)

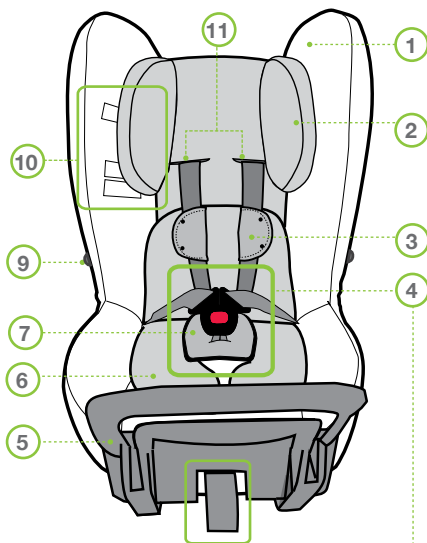

1. Padded cover for baby's comfort  
(May vary in style)
2. Adjustable headrest
3. Shoulder Pads (if supplied)
4. Harness Tongues and Buckle (Red button)
5. Stabilising Bar for Rearward Facing
6. Padded Insert (if supplied)
7. Crotch Pad (if supplied)
8. Headrest Adjuster Lever
9. Harness Tongue Holders
10. Shoulder Height Markers
11. Slots for Harness
12. Harness Adjuster
13. Harness Adjustment Strap

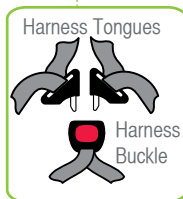
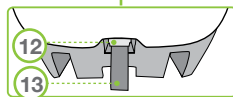



## SEATBELT ONLY VERSION

# FEATURES: REARWARD FACING

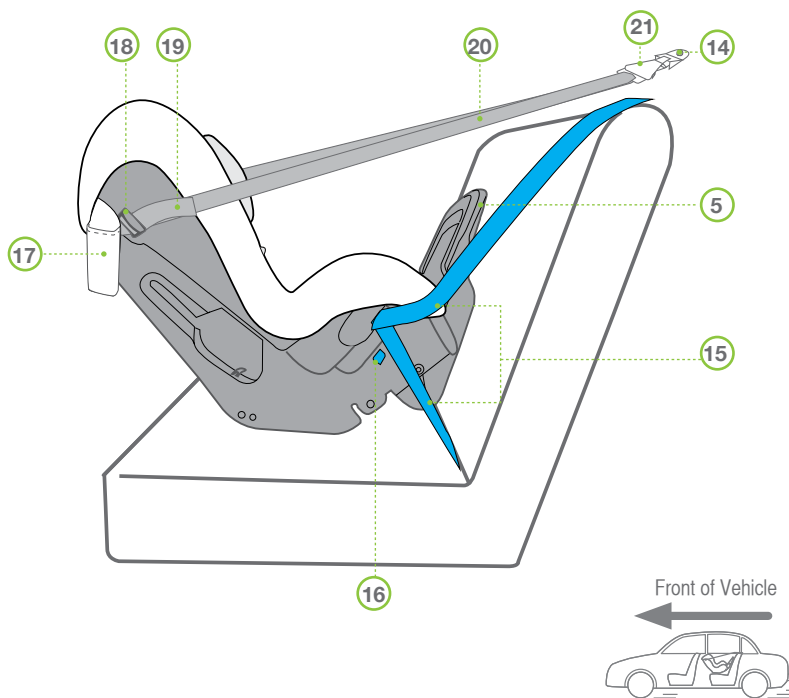

- 14. Vehicle Anchor Fitting
- 15. Vehicle lap-shoulder seatbelt
- 16. Blue **REARWARD FACING BELT PATH** label
- 17. Top Tether Storage Pocket
- 18. Top Tether Adjuster

- 19. Top Tether Adjustment Strap
- 20. Adjustable Top Tether Strap
- 21. Attachment Clip

ISOFIX COMPATIBLE VERSION

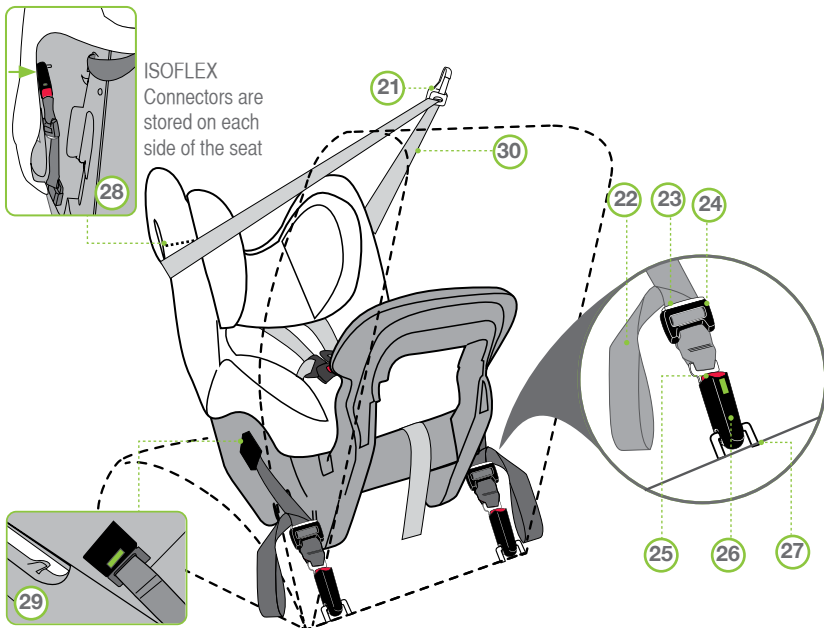

ISOFLEX CONNECTORS (IF FITTED)

- 22. ISOFLEX Strap
- 23. ISOFLEX Strap Adjuster Button
- 24. ISOFLEX Strap Adjuster
- 25. ISOFLEX Connector Release Button
- 26. ISOFLEX Connector
- 27. Vehicles ISOFIX low anchorage
- 28. ISOFLEX storage location
- 29. Tension Indicator (Green when activated)
- 30. Top Tether

Continue to use this child restraint in the rear facing mode until the child's shoulders reach the limit of the lower or middle shoulder height marker before turning the seat to face forward. A younger child's neck muscles may be unable to support their head thus the child should remain rear facing until the neck muscles can hold the head steady.

To ensure that the space is sufficient the purchaser should check the measurement between the seat back of the rear seat and all front seats in the car in which the child restraint is intended to be used. The length may be longer when the headrest is raised in rear facing mode. Regional Road Rules may prohibit the use of this restraint in the front seat until the child is 4 years of age. Check your Regional Road Rules for exemptions.

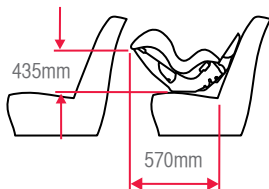

Seat Width 440mm



## WARNINGS

**DO NOT USE RESTRAINT IN REARWARD FACING MODE WITHOUT STABILISING BAR FULLY EXTENDED.**

Do not use the restraint without the top tether strap correctly attached to the vehicle anchorage.

**DO NOT USE A REAR FACING CHILD RESTRAINT WHERE AN AIRBAG IS FITTED IN FRONT OF THE SEATING POSITION.**

If an airbag is fitted in the desired seating position where the child restraint is fitted, follow the vehicle manufacturer's warnings and instructions. Do not use on any vehicle seat which faces sideways or rearwards.

Never leave babies or toddlers in a stationary car in the sun because of the risk of heat exhaustion. Ensure babies and toddlers have adequate ventilation and are shaded from direct sunlight through side or rear windows.

### CHILD RESTRAINT UPPER ANCHORAGE FITTING

To use this child restraint, the car will need a child restraint upper anchorage fitting in the seating position that you intend to use. Refer to the car owner's handbook.

The upper anchorage fitting is required for attaching the top tether in both rear facing mode and forward facing mode covered later in these instructions.

If no upper anchorage fitting is provided then you will need to install an upper anchorage fitting. Refer to pages 85 to 88.



Do not allow the front seat to alter the installed angle of the restraint. It is permissible to allow the restraint to touch the front vehicle seat.

## PREPARING FOR INSTALLING INTO VEHICLE - REARWARD FACING

The restraint is normally packaged in the fully upright forward facing mode. If you need to use it rearward facing you must first fully convert the restraint to rearward facing mode as shown below.

If upper anchorage strap is folded up for storage undo storage strap and lengthen. Fully press adjuster button (1) while pulling upper anchorage strap (2) to lengthen.

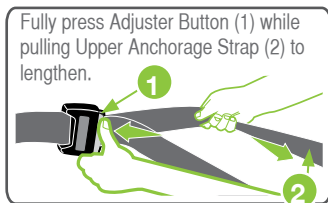

## CONVERT TO REARWARD FACING MODE

- A. Push the stabilising bar downward to unlock it from the seat.
- B. Rotate the stabilising bar around so that it is in position at the front of the seat.
- C. While in position, push down on the stabilising bar to lock into position as shown.

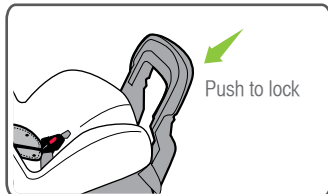
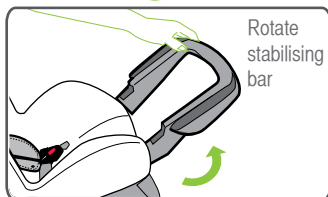

**! IMPORTANT:**  
DO NOT USE RESTRAINT IN REARWARD FACING MODE WITHOUT THE STABILISING BAR LOCKED IN POSITION.

## INSTALLING INTO A VEHICLE WITH SEATBELT. (REARWARD FACING)

- A. Position restraint rearward facing in the chosen seating position in the car where a child restraint anchor fitting is installed.

The restraint should be in contact with the vehicle seatback with the stabilising bar in position and latched.

Some vehicle seat fabrics (particularly velours) may be damaged by a child restraint used continuously. We recommend the use of a seat protector or thick towel to keep the vehicle seat in good condition.

- B. Undo the buckle and place buckle tongues in the Buckle Tongue Holders on each side of the cover.
- C. Remove baby insert (if fitted). Lift the centre panel flap and comfort pad from the inner seat.
- D. Fully lengthen seatbelt and feed between the comfort pad and the inner seat shell through seatbelt slot on each side. The slots are labeled in blue- **REARWARD FACING BELT PATH**.

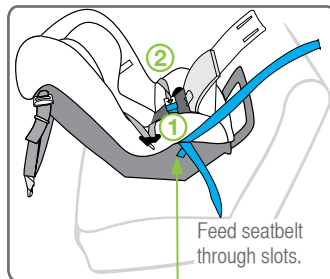
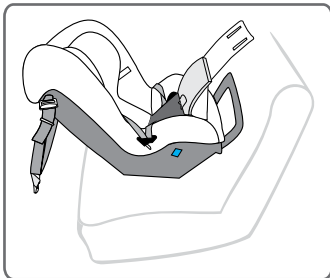
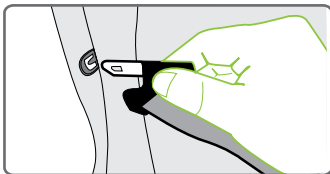

Feed seatbelt through slots.

Blue **REARWARD FACING BELT PATH** label

- E. Engage seatbelt buckle and tongue. Push down on the seat, whilst pulling the sash belt firmly to tighten the seatbelt. This will make the lap belt tight across the restraint. Whilst holding the seatbelt tension, ensure to remove all slack from lap part of seatbelt by pulling sash belt. For retractor seatbelts, allow excess belt to feed back into retractor.

**Always remove slack from seatbelt**

**A loose seatbelt is dangerous.**

**NOTE:** Seatbelt buckle and tongue must not rest between restraint cover and restraint. If seatbelt buckle is adjustable, adjust buckle as low as possible away from the restraint.

- F. Replace the comfort pad and centre panel flap, ensure the harness buckle is repositioned through the panel, clip any plastic fasteners that retain the cover. For smaller babies replace the insert pad (if supplied). Do not use insert pad if the child's shoulders reach the lower shoulder height marker or the child no longer fits the insert. See page 45 for advice on positioning the shoulder straps.

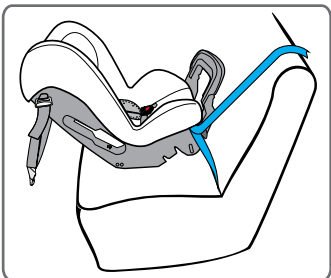
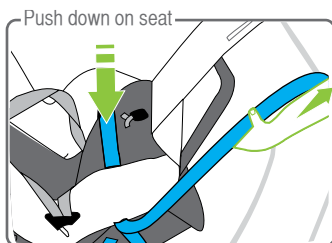
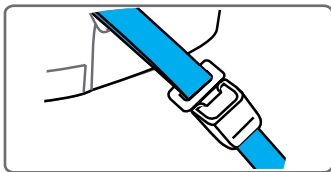

G. If upper anchorage strap is folded up for storage undo storage strap to lengthen. Fully press adjuster button (1) while pulling upper anchorage strap (2) to lengthen.

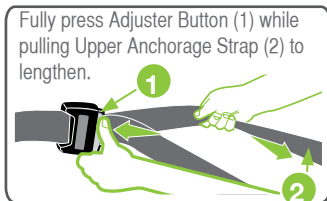

H. Fit the attachment clip to the car's anchor fitting as shown right. Make sure to remove as many twists as possible from the upper anchorage strap.

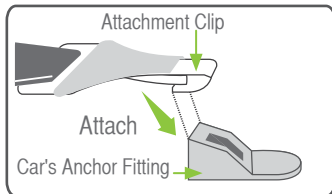

I. Tighten top tether strap by pulling adjustment strap to remove slack, leave the strap slack on the side the baby will be placed into the seat from. Any slack will be removed once the baby has been harnessed into the seat.

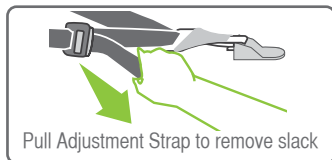

J. Remove the slack from the adjustable top tether strap by pulling adjustment strap. With the baby in harness, remove all slack in the top tether strap. Roll up excess strap and store in the pocket provided on the cover.

Do not tighten the top tether strap such that the restraint is lifted up. Remove slack only.

**Always remove slack from top tether.**

**A loose top tether is dangerous.**

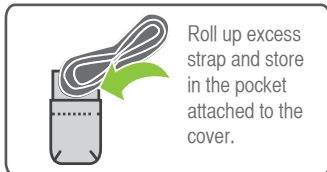

**⚠ CAUTION:**  
**CHILDREN CAN BE INJURED OR RESTRAINTS AND TOP TETHER STRAP DAMAGED BY UNSECURED CARGO IN A COLLISION. SECURE OR REMOVE HAZARDOUS CARGO BEFORE USING THIS CHILD RESTRAINT.**

## FITTING SUMMARY

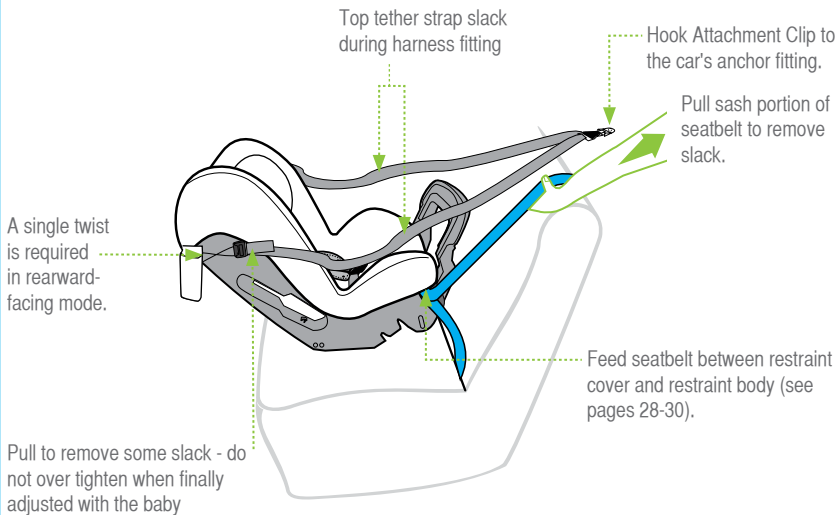

## WARNINGS

**DO NOT USE RESTRAINT IN REARWARD FACING MODE WITHOUT STABILISING BAR FULLY EXTENDED. THE TOP TETHER STRAP MUST ALWAYS BE FITTED WHEN THE CHILD RESTRAINT IS USED IN A VEHICLE. ALWAYS ATTACH THE HOOK AND REMOVE THE SLACK.**





### ANGULAR ADJUSTMENT OF RESTRAINT

Some vehicle seats have more rearward slope than others. If the angle of the seat causes the baby to be too upright for comfort, the angle may be altered by placing a firm packing between the seat and the underside of the base. Packing can be a firmly rolled up towel.

If the car's seat is flat then some packing may be required at the front edge of the base to achieve the recline angle.

**Do not remove all of the installation angle by over packing. Always leave an angle of approximately 10°- 15°.**

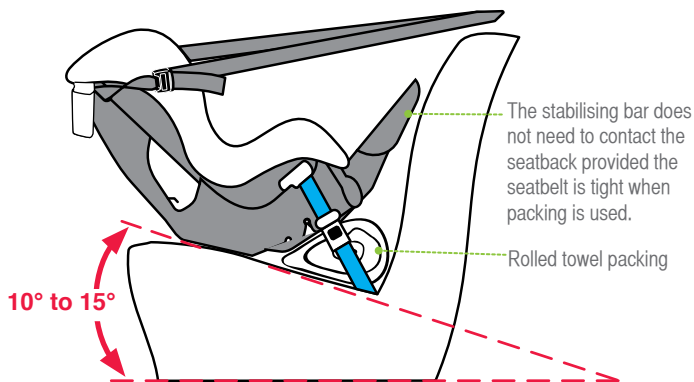

## INSTALLING THE RESTRAINT INTO THE CAR

### (USING ISOFLEX CONNECTORS IF SUPPLIED TO THE CHILD RESTRAINT)

To prevent damage to vehicle seat it may be necessary to remove or open a trim covering the ISOFIX low anchorages.

- A. Setup the seat for rear-facing mode by positioning the stabilising bar as described on page 27 and 28.
- B. Locate the ISOFIX Low Anchorages in the vehicle rear seat. If you cannot locate the ISOFIX bars, check your vehicle owners manual.

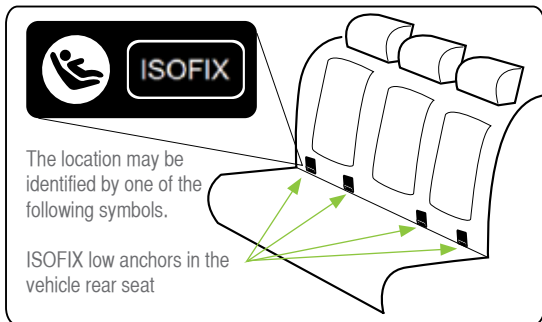

- C. With the restraint upright, remove both ISOFLEX connectors from storage on the upper sides of the restraint by pressing the red release button as shown.

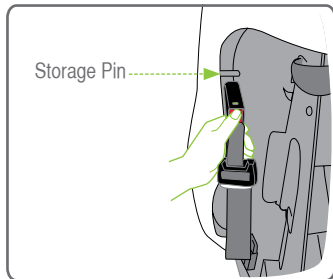

- D. Press and hold the ISOFLEX adjuster release button and pull the connector strap to fully lengthen. Repeat for both connector straps.

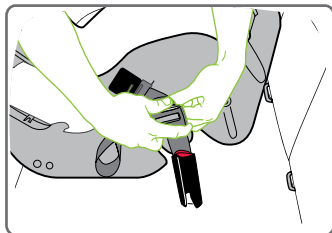

- E. Place the restraint in the desired location on the vehicle seat between the two ISOFIX low anchorages with the child seat against the vehicle seat back as shown.

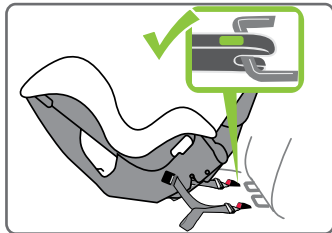

- F. The stabilising bar need not be in contact with the vehicle seat back but must be in position and latched. Engage the ISOFLEX connectors onto each ISOFIX lower anchorage. A green indicator will show on the top of the ISOFLEX connector when it has engaged. Pull each strap to ensure both lower anchorage connectors are engaged. Pull the adjusting strap to remove most of the slack on each side.

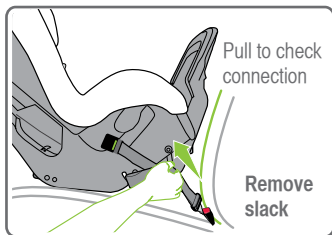

- G. Push downwards on the seat to compress the restraint into the vehicle seat. Whilst pushing, pull on each adjuster strap to remove all slack and tighten the ISOFLEX strap. Repeat for the other adjuster strap. Each tension indicators must show green indicating minimum tension has been applied.

Always remove slack from ISOFLEX Straps.

A loose installation is dangerous.

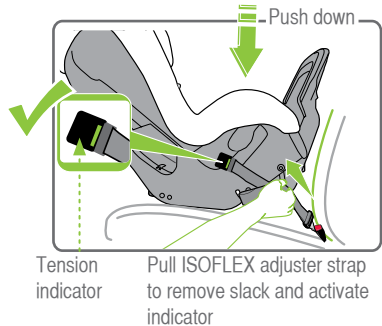

### IMPORTANT:

**Do not attach the lower attachment connectors of two separate child restraints to the same ISOFIX low anchorages in your car.**

**Always attach the top tether strap to the child restraint upper anchorage in your car.**

Child restraint lower attachment connectors and the ISOFIX low anchorages in your car are designed to withstand only those loads imposed by a correctly fitted child restraint.

H. If upper anchorage strap is folded up for storage undo storage strap to lengthen. Fully press adjuster button (1) while pulling upper anchorage strap (2) to lengthen.

I. Fit the attachment clip to the car's anchor fitting as shown right. Make sure to remove as many twists as possible from the upper anchorage strap.

J. Tighten top tether strap by pulling adjustment strap to remove slack, leave the strap slack on the side the baby will be placed into the seat from. Any slack will be removed once the baby has been harnessed into the seat.

K. Remove the slack from the adjustable top tether strap by pulling adjustment strap. With the baby in harness, remove all slack in the top tether strap. Roll up excess strap and store in the pocket provided on the cover.

Do not tighten the top tether strap such that the restraint is lifted up. Remove slack only.

**Always remove slack from top tether.**

**A loose top tether is dangerous.**

Fully press Adjuster Button (1) while pulling Upper Anchorage Strap (2) to lengthen.

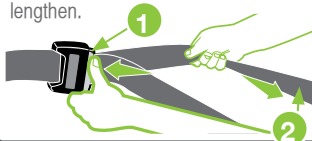

Attachment Clip

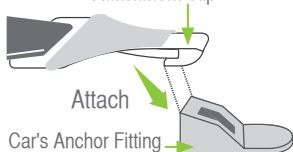

Pull Adjustment Strap to remove slack



Roll up excess strap and store in the pocket attached to the cover.

## **CAUTION:**

**CHILDREN CAN BE INJURED OR RESTRAINTS AND TOP TETHER STRAP DAMAGED BY UNSECURED CARGO IN A COLLISION. SECURE OR REMOVE HAZARDOUS CARGO BEFORE USING THIS CHILD RESTRAINT.**

## FITTING SUMMARY

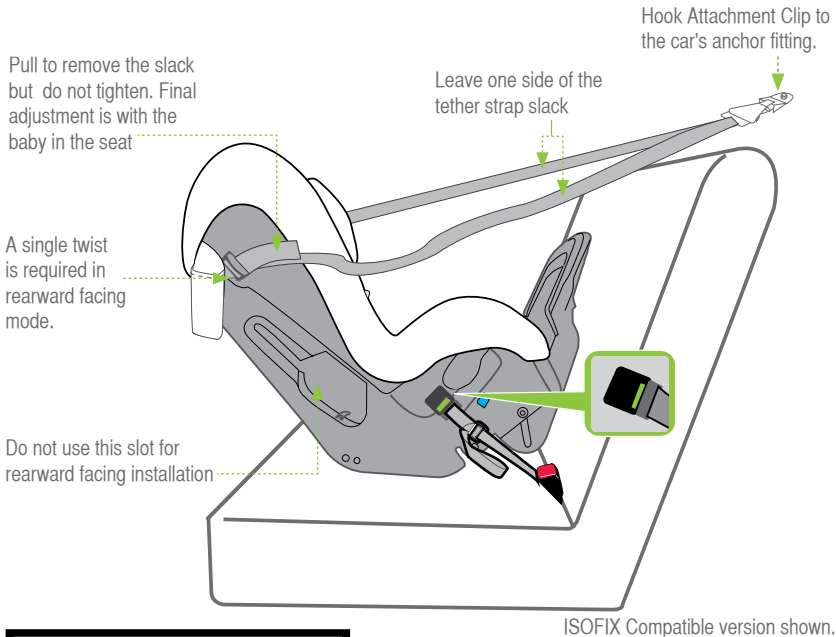
**WARNINGS**

**DO NOT USE RESTRAINT IN REARWARD FACING MODE WITHOUT STABILISING BAR FULLY DEPLOYED AND LOCKED THE TOP TETHER STRAP MUST ALWAYS BE FITTED WHEN THE CHILD RESTRAINT IS USED IN A VEHICLE. ALWAYS ATTACH THE HOOK AND REMOVE THE SLACK.**

If the car's child restraint anchor fitting is behind the vehicle seat back you may need to use an extension strap as part of the top tether installation.

**IMPORTANT:** If using an Extension Strap, positioning the attachment clip above the child may lead to injury in an accident therefore make sure that the attachment clip is not positioned in front of the vehicle seat. Use a shorter extension strap or no extension strap.

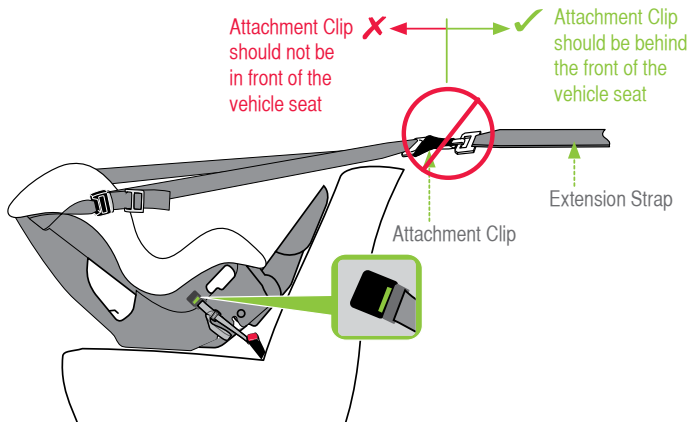

It is normal to have some sideways movement of the restraint if the headrest is pushed sideways. A firmer fit can be achieved by applying more force to the ISOFLEX adjuster strap. If the tether strap is over tightened, the installation angle of the restraint may be affected.



### **IMPORTANT :**

The Top tether strap must be fitted at all times when the baby is in the car when using either the seatbelt or the ISOFLEX connectors.

Always secure the loose end of the top tether strap to prevent it hanging out of the car or being accessible by the child.

**THIS RESTRAINT IS NOT SUITABLE FOR USE WHERE THE TOP TETHER STRAP MAY FALL INTO A SPLIT IN THE SEAT BACK OR OFF THE SIDE OF THE SEAT.**

**ALWAYS ATTACH TOP TETHER HOOK AND REMOVE SLACK IN THE TOP TETHER STRAP.**



### ANGULAR ADJUSTMENT OF RESTRAINT

Some vehicle seats have more rearward slope than others. If the angle of the seat causes the baby to be too upright for comfort, the angle may be altered by placing a firm packing between the seat and the underside of the base. Packing can be a firmly rolled up towel.

Do not remove all of the installation angle by over packing. Always leave an angle of approximately 10 to 15 degrees as shown

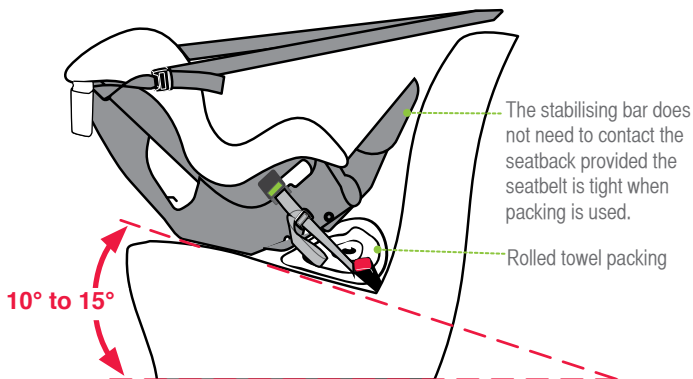

## INSTALLATION AND USE OF RESTRAINT

Correct fitment of the harness is very important as it restrains the baby in the seat. The headrest must be in the correct position, the harness must fit firmly around the upper torso of the baby and be positioned so as to leave the baby's arms and legs free.

For babies in rear facing mode the headrest must be in the position where the top of the shoulder strap slots are nearest to the child's shoulders, but not lower than the child's shoulders. Instructions for adjusting the headrest are on page 42. If your baby has reached the lower shoulder height marker then the restraint may be converted to forward facing (refer to Forward Facing section from page 51) mode. However it is preferable to remain rear facing for longer, Forward facing must be used when the child's shoulders reach the middle shoulder height marker.

## HOW TO USE THE HEADREST

First remove both harness straps (refer to page 43), then rotate lever down to release headrest clamp (A). Slide the headrest up or down to suit the height of your child (from page 65 for toddler use). In rearward facing mode, move the headrest so that the bottom slots in the headrest line up with the top of the child's shoulders. If the headrest slots do not align to a shell slot, move the headrest up to the next set of slots. Do not move headrest downwards. Rotate the lever upward to lock the headrest clamp (B). Refit both harness straps, ensuring that there are no twists and that each strap is in the correct and matching slots in both the seat shell and headrest (refer to page 42).

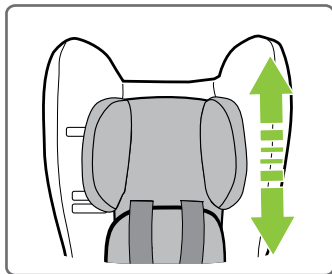
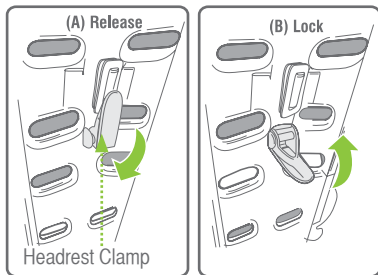

## ADJUSTING SHOULDER HARNESS STRAPS HEIGHT

Always adjust the harness slot position as the child grows. If your child has reached the middle shoulder height marker then the restraint must be converted to Forward Facing mode (refer to Forward Facing section starting on page 57).

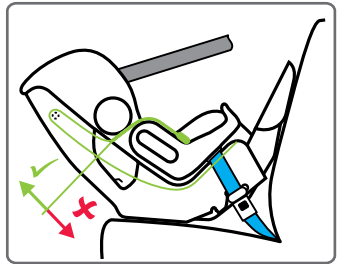

The shoulder straps must be in the slots which are nearest to the child's shoulders, but not lower than the child's shoulders.

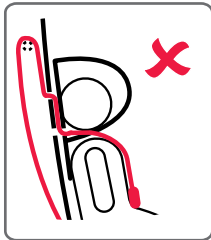
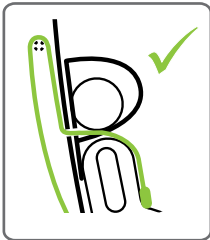

Shoulder straps **must** be threaded directly through appropriate shoulder strap slots then **over the top** of bar at rear of restraint. Harness straps must never be routed through headrest and shell slots at similar heights.

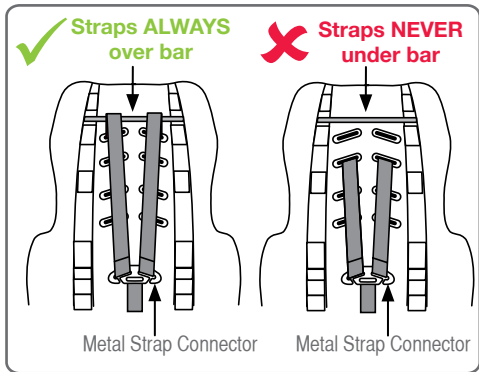

## IMPORTANT :

Always adjust the height of the headrest, thus the shoulder straps as child grows.

## STEPS IN CHANGING SHOULDER STRAP SLOTS

- A. Remove the restraint from vehicle.
- B. At the rear of the restraint, remove one of the harness shoulder straps from Metal Strap Connector by slipping strap through open slot.
- C. Pull the shoulder straps through slot.
- D. Adjust the headrest and ensure the chosen slots align with the restraint body.
- E. Insert shoulder strap through restraint slot which will position the shoulder strap level with or above the child's shoulder, **then over the metal cross bar**. Ensure that the shoulder strap passes through matching slots in cover, headrest and restraint body. If using an accessory with slots, ensure the straps are threaded through these before inserting the strap in the slots in the backrest.
- F. Reconnect the strap to the metal strap connector.

**IMPORTANT:**

Ensure each shoulder strap is threaded through aligned headrest and seat shell slots, then over the top of the bar at the rear of restraint and connects to the metal strap connector.

Do not use the restraint with harness shoulder straps set at different heights

or fed through mismatching slots. Ensure harness straps are not twisted and that all straps are secure by pulling each harness strap.

Remove accessories while adjusting harness. The accessories are not to be used once child reaches the Lower Shoulder Height Marker or if it creates discomfort.

Do not adjust headrest position without checking harness strap position.

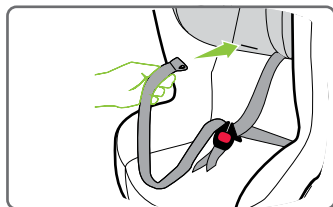
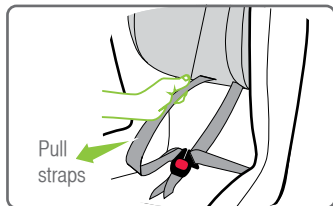
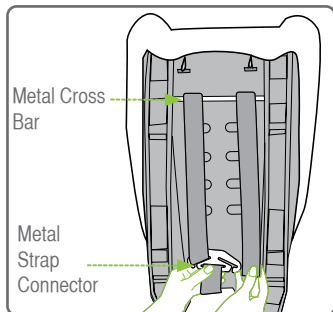

## PLACING CHILD INTO RESTRAINT (REARWARD FACING)

- A. Check that the harness shoulder straps are in the correct position. Refer to pages 43 for correct shoulder harness strap height and for setting up the harness.
- B. Slacken the top tether strap if not already slack and allow the straps to fall to the sides of the restraint for easier access to the child.
- C. Loosen shoulder straps by pushing in the harness adjuster and pulling both shoulder straps evenly. Pull out the desired amount of slack.
- D. Store buckle tongues on the buckle tongue holders while placing baby in the child restraint.
- E. Place baby into child restraint lying on its back so that the buckle is between the baby's legs. Ensure that baby's arms and legs are free. Make sure baby is dressed to allow the Harness Buckle to be pulled up between baby's legs e.g. a jump suit.

NOTE: The headrest should be adjusted so that shoulder strap slots and headrest wings are just above the shoulders, not below the shoulders.

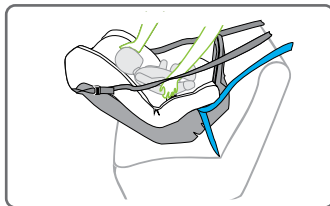
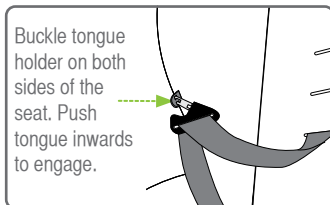
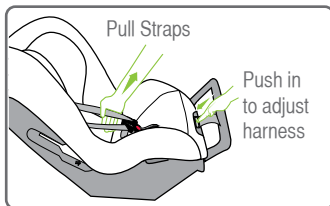

### CAUTION:

Do not harness an infant wrapped in a blanket or swaddled as this increases the risk of ejection and injury or death in a crash. The harness needs to fit firmly to the baby, any blanket or other covering may be placed over the harness after the harness is adjusted. Arms and legs must be free and not bound or wrapped together. The legs must sit on each side of the crotch strap.



### IMPORTANT :

Always adjust the height of the headrest thus the shoulder straps as the child grows.

- F. Fit either harness tongue into the harness buckle followed by the other tongue. A click is heard when the last tongue is fully engaged.
- Should the second tongue not engage - press the red button and reinsert the tongues. Ensure secure engagement by pulling harness straps. If the harness buckle does not engage correctly then it may require cleaning or seek replacement - refer to page 84.
- The buckle tongues are fully engaged when both tongues are inserted and a 'click' is heard.**

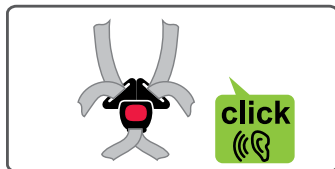
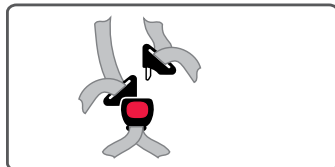
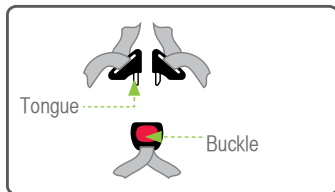

- G. Ensure slack is removed from harness lap strap by pulling shoulder straps then pull harness adjustment strap to adjust harness to a comfortable but firm fit. Ensure that any slack in harness straps is removed. Shoulder harness straps must fit firmly to the child. A loose harness could result in serious injury in an accident. Do not over tighten.

**Do not use the restraint if straps do not tighten. Contact your local authorised service agent for repair.**

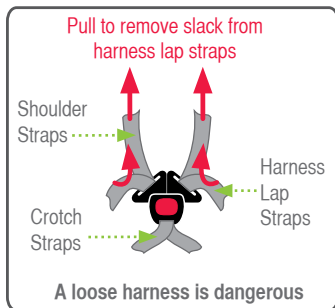

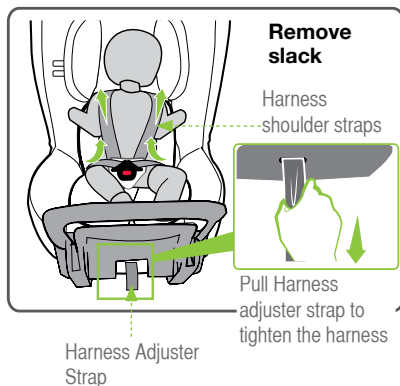
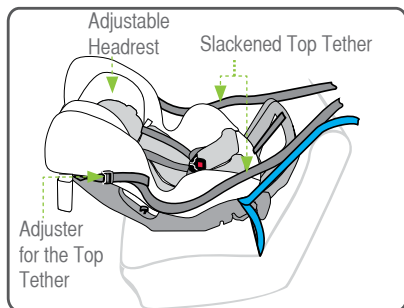

**WARNING: DO NOT LEAVE CHILDREN UNATTENDED IN THE CAR.**



**CAUTION: ALWAYS REMOVE SLACK  
A LOOSE HARNESS IS DANGEROUS.**

Make sure that nothing is obstructing harness straps and that child's arms and legs are free with the straps in the correct location - see previous page.

Do not use the restraint if straps do not tighten and contact BRITAX Childcare Customer Service. Refer to back cover for contact details.



**IMPORTANT :**

The padded insert is designed to provide extra support and comfort and may be used for smaller children. Discontinue use when Padded insert is a tight fit, creates discomfort for larger children, or the child's shoulder reach the lower shoulder height marker.

- H. Adjust the top tether strap by pulling adjustment strap to remove slack as shown. Ensure the strap is not so tight as to lift the seat or deform the headrest. Only remove the slack.

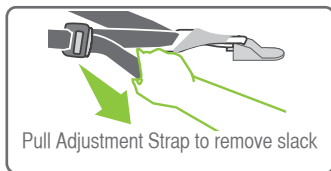

- I. Always roll up excess strap and place in the pocket provided attached to the cover.

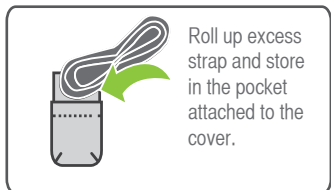



## REMOVING CHILD FROM RESTRAINT

- Press top tether strap adjuster button while pulling top tether strap to slacken. Allow top tether straps to fall to the sides for easy access into restraint and child removed.
- Push and hold the harness adjustment button or lever while pulling both shoulder harness straps to fully slacken the harness. Insert the tongues into the harness tongue holders.
- Press the red button on harness buckle, both harness tongues will be released. Insert tongues into tongue holders to hold straps away from the child. Move shoulder straps to baby's side then remove baby.
- To remove the seat refer to page 50 for ISOFLEX installation or page 49 for seatbelt installation.

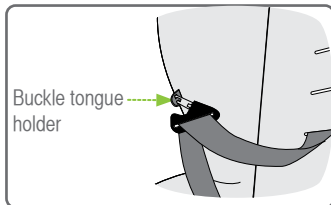
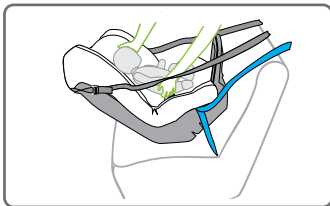

## REMOVE RESTRAINT FROM VEHICLE FITTED WITH SEATBELT AND TOP TETHER

- Disengage the vehicle seatbelt buckle. Remove seatbelt from the restraint belt paths.
- Remove the top tether strap from pocket and fully press top tether adjuster button (1) while pulling top tether strap (2) to slacken as shown. In some vehicles loosening of the top tether strap may be difficult. If so, try pushing the restraint against the vehicle seat back or slightly lifting the restraint to release the tension.
- Disengage the attachment clip from upper anchorage fitting. The child restraint is now disconnected.
- Roll up and store the loose top tether strap in the pocket provided to avoid tripping.

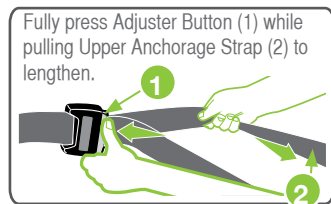

- E. To convert the restraint from Rearward Facing mode to Forward Facing mode, Pull the stabilising bar upward and away from the seat to unlock and rotate.
- F. Rotate the stabilising bar around so that it is in position at the bottom rear of the seat. Either recline or upright position may be set by locking into the forward or rearward slot.
- G. Disengage seatbelt tongue from buckle and remove the seatbelt from the restraint belt paths. Allow seatbelt to feed back into seatbelt retractor.

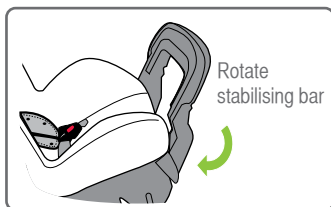
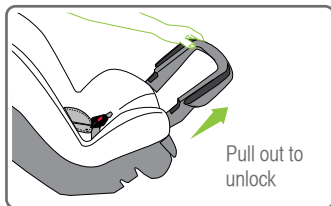

## DISCONNECT TOP TETHER AND ISOFLEX CONNECTORS

To store the ISOFLEX connectors on the inside of the seat wings.

- A. Press the ISOFLEX strap adjuster button to release tension on the straps.
- B. Press each of the red release buttons on the ISOFLEX connectors and remove them from the vehicle ISOFIX low anchorages.
- C. Fully lengthen the ISOFLEX strap and engage each ISOFLEX connector onto its storage pin.

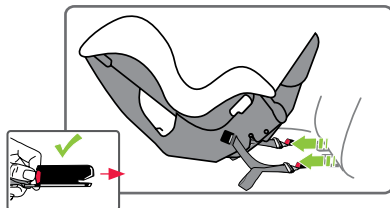

Storage Pin

Remove slack but do not tighten. The storage pin may be damaged if the strap is tightened.

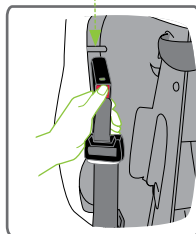
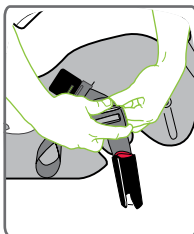

- D. Remove the excess tether strap from pocket and fully press top tether adjuster button (1) while pulling top tether strap (2) to slacken as shown. In some vehicles loosening of the top tether strap may be difficult. If so, try pushing the restraint against the vehicle seat back or slightly lifting the restraint to release the tension.

Store loose strap in the storage pocket provided on the cover.

- E. Disengage the attachment clip from upper anchorage fitting. The child restraint is now disconnected.

Store loose strap in the storage pocket provided on the cover.

- F. To convert the restraint from Rearward Facing mode to Forward Facing mode, Pull the stabilising bar upward and away from the seat to unlock and rotate.

- G. Rotate the stabilising bar around so that it is in position at the bottom rear of the seat. Either recline or upright position may be set by locking into the forward or rearward slot.

Fully press Adjuster Button (1) while pulling Upper Anchorage Strap (2) to lengthen.

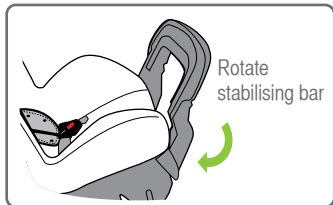
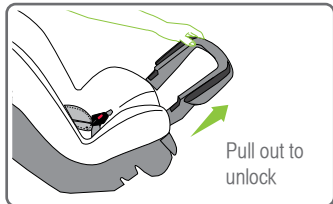
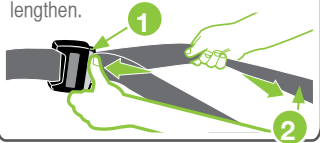

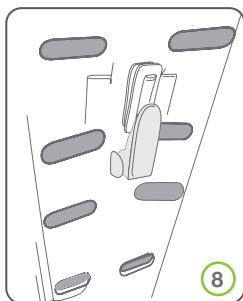

(Harness strap not shown)

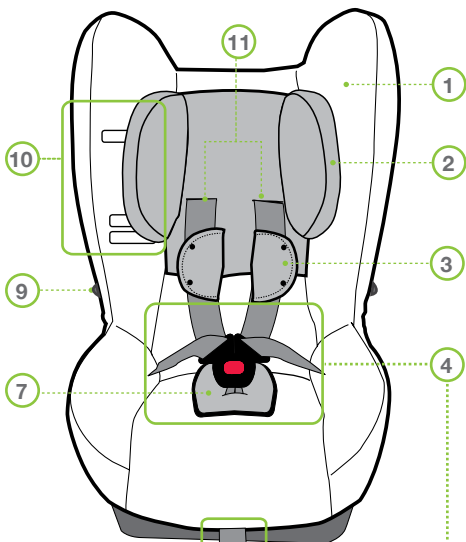

1. Padded cover for child's comfort  
(May vary in style)
2. Adjustable headrest
3. Shoulder Pads (if supplied)
4. Harness Tongues and Buckle (Red button)
5. Harness Adjustment Strap
6. Harness Adjuster
7. Crotch Pad (if supplied)
8. Headrest Adjuster Lever
9. Harness Tongues Holders
10. Shoulder Height Markers
11. Slots for Harness

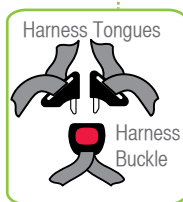
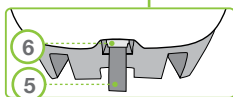

## SEATBELT ONLY VERSION

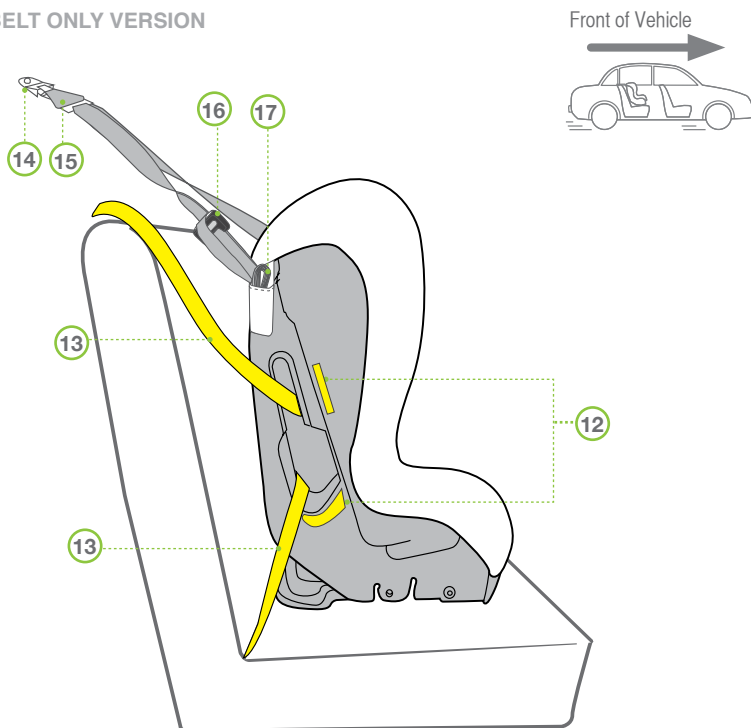

- 12. Yellow **FORWARD FACING BELT PATH** labels
- 13. Vehicle Lap-sash seatbelt
- 14. Car's Upper Anchorage Fitting
- 15. Attachment Clip
- 16. Top Tether Strap Adjuster
- 17. Top Tether Strap (shown with loose end stored in pocket).

ISOFIX COMPATIBLE VERSION

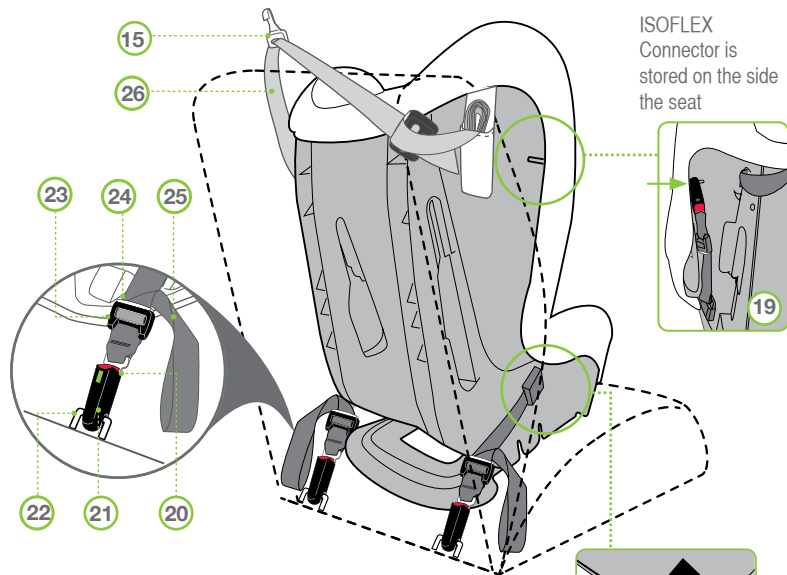

ISOFLEX Connector is stored on the side of the seat

ISOFLEX CONNECTORS (IF FITTED)

- 18. Tension Indicator (green when activated)
- 19. ISOFLEX Storage Location
- 20. ISOFLEX Connector Release Button
- 21. ISOFLEX Connector
- 22. Vehicles ISOFIX low anchorage
- 23. ISOFLEX Strap Adjuster
- 24. ISOFLEX Strap Adjuster Button
- 25. ISOFLEX Strap
- 26. Top Tether

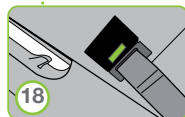

Once the child's shoulders reach the lower or middle shoulder height marker, the seat may be changed to the forward-facing mode and used until the child's shoulders reach the upper shoulder height marker.

The child should not sit forward-facing until their neck muscles are able to support their head.

Do not move to a Booster Seat until the child has outgrown this child restraint.

Children are at risk of serious injury if they move to a booster seat too early.

Regional Road Rules may prohibit the use of this restraint in the front seat of the vehicle until the child is 4 years of age. Check your Regional Road Rules for exemptions.



## WARNINGS

**DO NOT USE RESTRAINT IN FORWARD-FACING MODE WITH THE REAR FACING MODE STABILISING BAR DEPLOYED.**

Do not use the restraint without the top tether strap correctly attached to the vehicle anchorage.

If your vehicle is not fitted with an anchor point, please contact a Safety Restraint Fitting Station authorised by the relevant State Government Body for correct fitment of the restraint. In New Zealand contact the agent for the vehicle. The top tether strap must be attached to an upper anchorage point using an extension strap if necessary.

Do not use on any vehicle seat which faces sideways or rearwards.

If an airbag is fitted in the desired seating position where the child restraint is fitted, follow the vehicle manufacturer's warnings and instructions.

## INSTALLING INTO VEHICLE FORWARD FACING

- A. Remove the installed rear facing child seat from the vehicle by disengaging the seatbelt or ISOFLEX straps and upper anchorage strap as described on pages 49 to 51.
- B. Remove the padded insert (if supplied) as this is no longer required.
- C. Pull the stabilising bar upward and away from the seat to unlock and rotate.

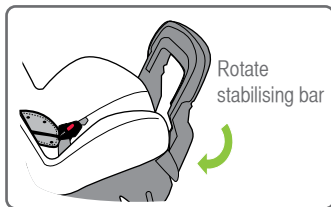
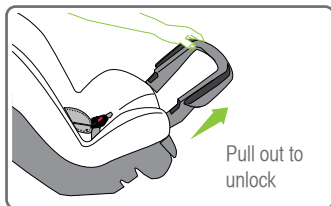
**IMPORTANT :**

**DO NOT USE RESTRAINT IN FORWARD-FACING POSITION WITH THE STABILISING BAR PULLED OUT.**

**Do not recline into rearward facing position when using restraint in forward facing mode.**

Ensure harness and headrest are in the correct position (Refer to page 66-67).



## CONVERT THE RESTRAINT TO FORWARD FACING MODE (UPRIGHT OR RECLINED)

- A. Rotate the stabilising bar around so that it is in position at the bottom rear of the seat. Either recline or upright position may be set by locking into the forward or rearward slot.
- B. Refer to illustration for slot locations.

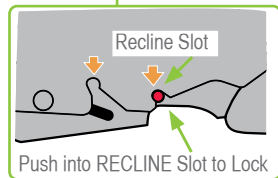
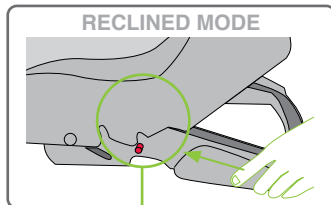
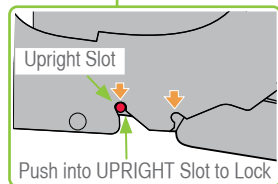
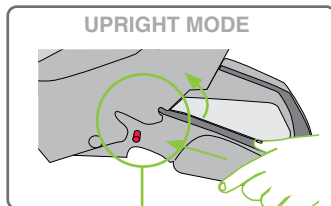

## INSTALLING INTO VEHICLE FORWARD FACING -WITH SEATBELT

- A. Position the restraint in the car facing forward in the chosen seating position. There should be a child restraint anchorage fitting directly behind this seating position. Refer to the vehicle owners manual for the location. If not, refer to pages 83 to 86.
- B. Some vehicle seat fabrics (particularly velours) may be damaged by a child restraint used continuously. We recommend the use of a seat protector or thick towel to keep the vehicle seat in good condition.
- C. Fully lengthen seatbelt. Insert seatbelt tongue through the forward facing seatbelt path (yellow path), ensuring that the seatbelt is behind the harness straps and that the lap part of the seatbelt is below the hooks.

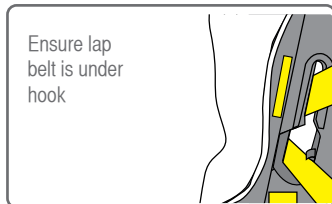
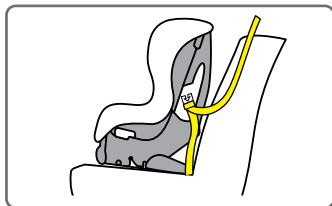

- D. Engage seatbelt buckle & tongue. Push down on the seat, whilst pulling the sash belt firmly. This should make the lap belt tight across the restraint. Whilst holding the seatbelt tension, ensure to remove all slack from the lap part of the seatbelt (1) by pulling sash belt (2).
- E. The child restraint should now be firmly fitted to the vehicle seat. Allow the excess sash belt to feed back into retractor ensuring no slack has been created by the belt path.

**NOTE:** Seatbelt extenders should not be used if the seatbelt is long enough to secure the child restraint. If they are used, the buckle must not enter the forward facing belt path.

Always remove slack from seatbelt.

A loose seatbelt is dangerous.

- H. If upper anchorage strap is folded up for storage undo storage strap then lengthen. Fully press adjuster button (1) while pulling upper anchorage strap (2) to lengthen.
- I. Fit the attachment clip on the upper anchorage strap to the anchor fitting as shown. Make sure to remove as many twists as possible from the upper anchorage strap.

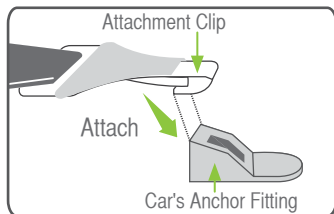
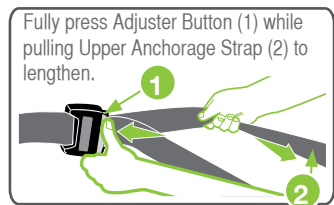
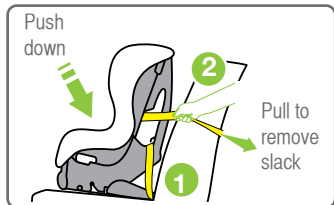
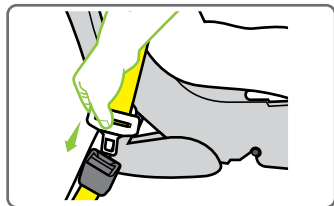

**WARNING**

Always attach the hook and remove slack

- J. Tighten adjustable top tether strap by pulling adjustment strap to remove slack as shown below, but do not over-tighten causing the restraint base to lift off the vehicle seat.

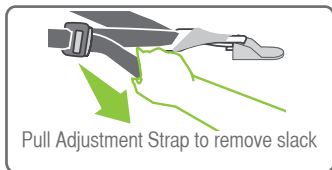

- K. Fold up excess strap and use the top tether pocket to store excess strap away from child's reach.

Always remove slack from top tether.  
A loose top tether is dangerous.

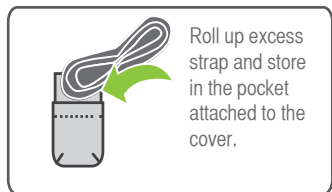

### IMPORTANT :

Always secure the loose end of the top tether strap to prevent it hanging out of the car or being accessible by the child.

**THIS RESTRAINT IS NOT SUITABLE FOR USE WHERE THE TOP TETHER STRAP MAY FALL INTO A SPLIT IN THE SEAT BACK OR OFF THE SIDE OF THE SEAT.**

Always ensure that the car seatbelt is firmly restraining the restraint on the vehicle seat.

**ALWAYS ATTACH TOP TETHER HOOK AND REMOVE SLACK IN THE TOP TETHER STRAP.  
A LOOSE TOP TETHER IS DANGEROUS.**

Check that the seatbelt is not twisted and the diagonal belt is only clamped by the lock-off which is located on the opposite side from the car seat buckle.



### CAUTION:

**CHILDREN CAN BE INJURED OR RESTRAINTS AND TOP TETHER STRAP DAMAGED BY UNSECURED CARGO IN A COLLISION. SECURE OR REMOVE HAZARDOUS CARGO BEFORE USING THIS CHILD RESTRAINT.**

FITTING SUMMARY

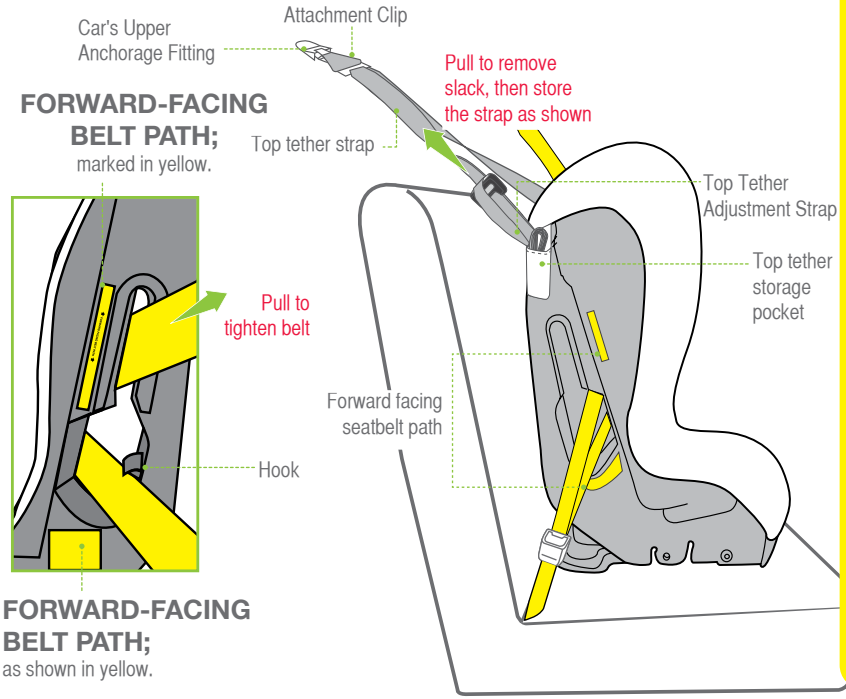

**INSTALLING THE RESTRAINT INTO THE CAR**  
**(USING ISOFLEX CONNECTORS IF SUPPLIED WITH THE CHILD RESTRAINT)**

To prevent damage to vehicle seat it may be necessary to remove or open a trim covering the ISOFIX low anchorages.

- A. Locate the ISOFIX Low Anchorages in the vehicle rear seat. If you cannot locate the ISOFIX bars, check your vehicle owners manual.

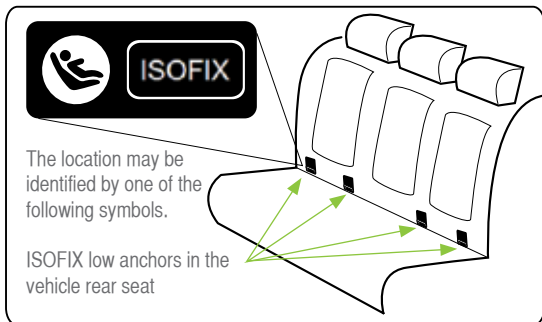

- B. With the restraint upright, remove both ISOFLEX connectors from storage on the upper sides of the restraint by pressing the red release button on the connector.

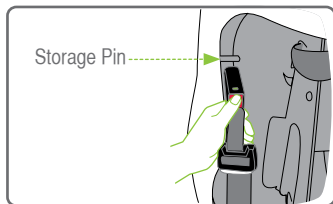

- C. Recline instructions are shown on page 57.

- D. Press and hold the ISOFLEX strap adjuster button and pull the connector strap to fully lengthen. Repeat for both connector straps.

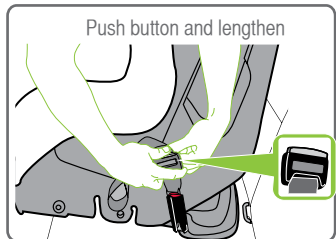

- E. Place the restraint in the desired location on the vehicle seat between the two ISOFIX low anchorages.
- F. Ensure the child seat is against the vehicle seat back as shown. Engage each ISOFLEX connector onto each ISOFIX lower anchorage. A green indicator will show on the top of the ISOFLEX connector when it has engaged. Pull the adjusting strap to remove most of the slack on each side.
- G. Push downwards on of the seat to compress it into the vehicle seat. Whilst pushing, pull on adjuster strap to remove all slack and tighten the ISOFLEX strap. Repeat for the other adjuster strap.
- H. Each tension indicators must show 'green' indicating minimum tension has been applied.

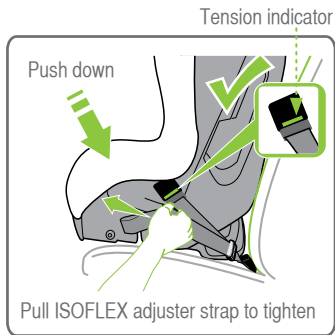
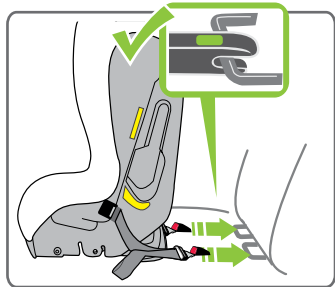

Always remove slack from ISOFLEX Straps.

A loose installation is dangerous.



### IMPORTANT:

**Do not attach the lower attachment connectors of two separate child restraints to the same ISOFIX low anchorages in your car.**

**Always attach the top tether strap to the child restraint upper anchorage in your car.**

Child restraint lower attachment connectors and the ISOFIX low anchorages in your car are designed to withstand only those loads imposed by a correctly fitted child restraint.

- I. If upper anchorage strap is folded up for storage undo storage strap then lengthen. Fully press adjuster button (1) while pulling upper anchorage strap (2) to lengthen.
- J. Fit the attachment clip on the upper anchorage strap to the anchor fitting as shown. Make sure to remove as many twists as possible from the upper anchorage strap.



## WARNING

### Always attach the hook and remove slack

- K. Tighten adjustable top tether strap by pulling adjustment strap to remove slack as shown below, but do not over-tighten causing the restraint base to lift off the vehicle seat.
- L. Fold up excess strap and use the top tether pocket to store excess strap away from child's reach.



### IMPORTANT :

Always secure the loose end of the top tether strap to prevent it hanging out of the car or being accessible by the child.

**THIS RESTRAINT IS NOT SUITABLE FOR USE WHERE THE TOP TETHER STRAP MAY FALL INTO A SPLIT IN THE SEAT BACK OR OFF THE SIDE OF THE SEAT.**

Always ensure that the car seatbelt is firmly restraining the restraint on the vehicle seat.

**ALWAYS ATTACH TOP TETHER HOOK AND REMOVE SLACK IN THE TOP TETHER STRAP.**

**A LOOSE TOP TETHER IS DANGEROUS.**

Check that the seatbelt is not twisted and the diagonal belt is only clamped by the lock-off which is located on the opposite side from the car seat buckle.

Fully press Adjuster Button (1) while pulling Upper Anchorage Strap (2) to lengthen.

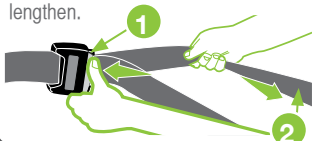

Attachment Clip

Attach

Car's Anchor Fitting

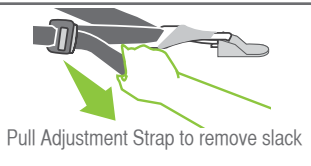
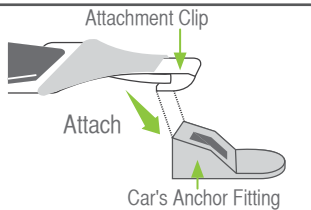

Roll up excess strap and store in the pocket attached to the cover.



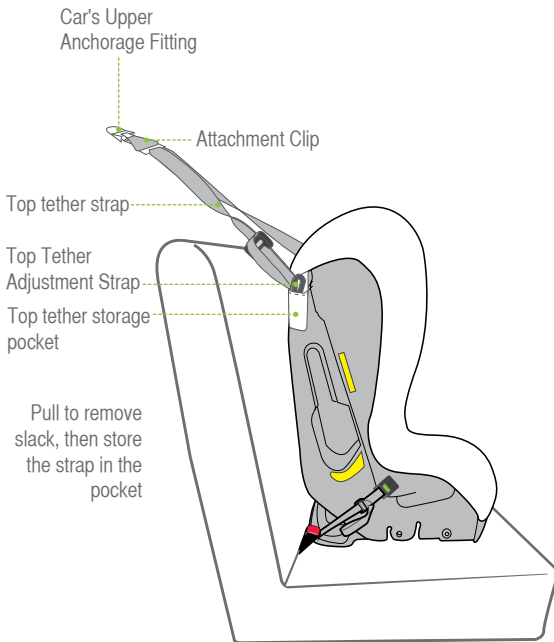

Front of Vehicle

**IMPORTANT:**

Always secure the loose end of the top tether strap to prevent it hanging out of the car or being accessible by the child.

**THIS RESTRAINT IS NOT SUITABLE FOR USE WHERE THE TOP TETHER STRAP MAY FALL INTO A SPLIT IN THE SEAT BACK OR OFF THE SIDE OF THE SEAT.**

## HOW TO USE THE HEADREST

First remove both harness straps (refer to page 43), then rotate lever down to release headrest clamp (A). Slide the headrest up or down to suit the height of your child (from page 65 for toddler use). In rearward facing mode, move the headrest so that the bottom slots in the headrest line up with the top of the child's shoulders. If the headrest slots do not align to a shell slot, move the headrest up to the next set of slots. Do not move headrest downwards. Rotate the lever upward to lock the headrest clamp (B). Refit both harness straps, ensuring that there are no twists and that each strap is in the correct and matching slots in both the seat shell and headrest (refer to page 42).

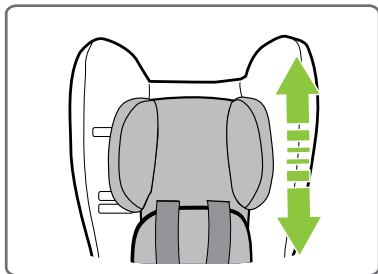
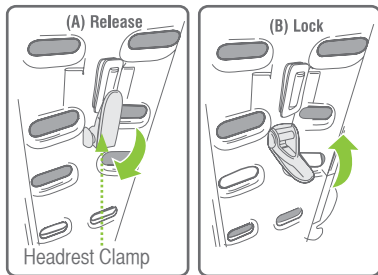

## ADJUSTING SHOULDER HARNESS STRAPS HEIGHT

Correct fitment of the harness is very important as it restrains the child in the restraint. The headrest must be in the correct position and the harness must fit firmly around upper torso of the child and be positioned so as to leave the child's arms and legs free.

For forward facing mode the shoulder strap slots need to be nearest to the child's shoulders, but not lower than 25mm below the child's shoulders. **Always adjust the height of the headrest, thus the shoulder straps as the child grows.** Adjust the harness to the desired position, see page 66. Remove the accessories (if fitted) when adjusting the straps. If your child has reached the upper shoulder height marker then refer to page 21 for next type of restraint.

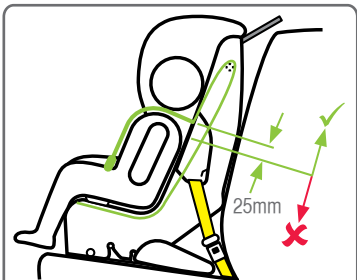

The shoulder straps must be in the slots which are nearest to the child's shoulders, but not more than 25mm below the child's shoulders.

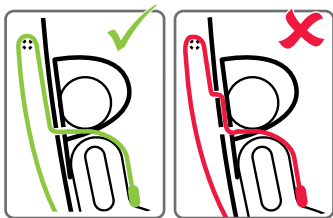

Shoulder straps **must** be threaded directly through appropriate shoulder strap slots then **over the top** of bar at rear of restraint. Harness straps must never be routed through headrest and shell slots at similar heights.

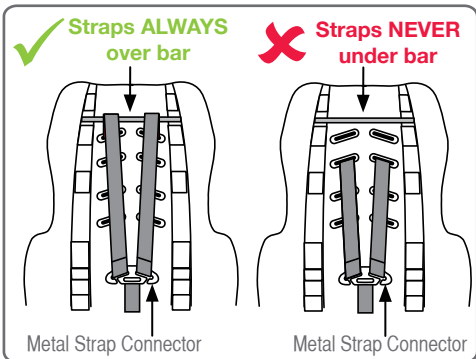

**IMPORTANT:** Padded Insert is not to be used when forward facing.  
Always adjust the height of the headrest, thus the shoulder straps as the child grows.

## STEPS IN CHANGING SHOULDER STRAP SLOTS

- Remove the restraint from vehicle, if not already removed.
- At the rear of the restraint, remove one of the harness shoulder straps from Metal Strap Connector by slipping strap through open slot.
- Pull the shoulder straps through slot.
- Adjust the headrest and ensure the chosen slots align with the restraint body.
- Insert shoulder strap through restraint slot which will position the shoulder strap level with or above the child's shoulder, **then over the metal cross bar**. Ensure that the shoulder strap passes through matching slots in cover, headrest and restraint body. If using an accessory with slots, ensure the straps are threaded through these before inserting the strap in the slots in the backrest.
- Reconnect the strap to the metal strap connector.

**IMPORTANT:**

Ensure each shoulder strap is threaded through aligned headrest and seat shell slots, then over the top of the bar at the rear of restraint and connects to the metal strap connector.

Do not use the restraint with harness shoulder straps set at different heights

or fed through mismatching slots. Ensure harness straps are not twisted and that all straps are secure by pulling each harness strap.

Remove accessories while adjusting harness. The accessories are not to be used once child reaches the Lower Shoulder Height Marker or if it creates discomfort.

Do not adjust headrest position without checking harness strap position.

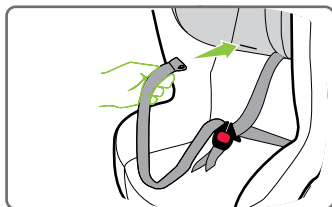
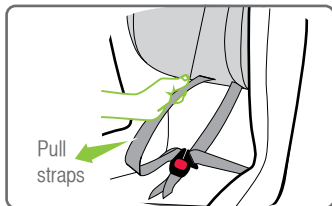
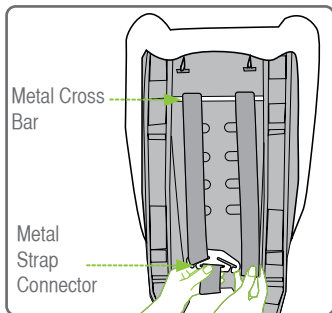

## PLACING CHILD INTO RESTRAINT

- A. Check that the harness shoulder straps are in the correct position. Refer to page 67 for correct shoulder harness strap height and for setting up the harness.
- B. Loosen shoulder straps by pushing in the harness adjuster and pulling both shoulder straps evenly. Pull out the desired amount of slack. Press the harness buckle button to release tongues. Store the tongues in the buckle tongue holders while placing child in the restraint.
- C. Place child in the restraint and feed each arm through shoulder straps. Place harness buckle between child's legs.
- D. Fit either harness tongue into the harness buckle followed by the other tongue. A click is heard when the last tongue is fully engaged.  
Should the second tongue not engage - press the red button and reinsert the tongues. Ensure secure engagement by pulling harness straps. If the harness buckle does not engage correctly then it may require cleaning or seek replacement - refer to page 84. **The buckle tongues are fully engaged when both tongues are inserted and 'click' is heard.**

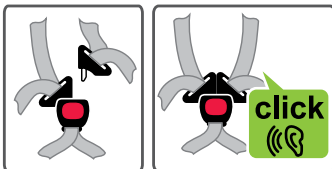
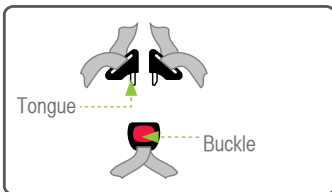
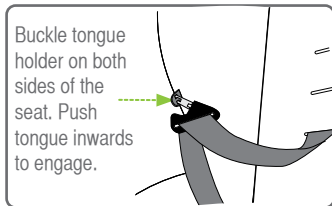
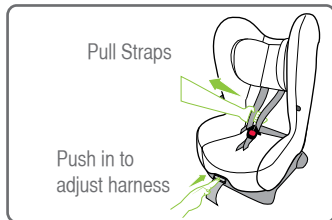

- D. Ensure slack is removed from harness lap strap by pulling shoulder straps then pull harness adjustment strap to adjust harness to a comfortable but firm fit. Ensure that any slack in harness straps is removed. Shoulder harness straps must fit firmly to the child. A loose harness could result in serious injury in an accident.

Do not use the restraint if straps do not tighten. Contact your local authorised service agent for repair.

Store instruction manual in pocket provided and tuck pocket under trim cover.

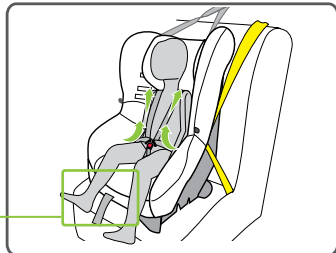
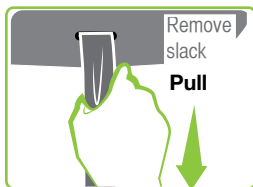
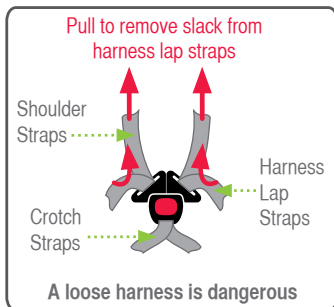

**! WARNING: DO NOT LEAVE CHILDREN UNATTENDED IN THE CAR.**

**! CAUTION: ALWAYS REMOVE SLACK  
A LOOSE HARNESS IS DANGEROUS.**

Make sure that nothing is obstructing harness straps and that child's arms and legs are free with the straps in the correct location - see previous page.

Do not use the restraint if straps do not tighten and contact BRITAX Childcare Customer Service. Refer to back cover for contact details.

## REMOVING CHILD FROM RESTRAINT

- A. Push and hold the harness adjustment button while pulling both shoulder harness straps to slacken harness.
- B. Press the red button on harness buckle, both harness tongues will be released. Insert tongues into tongue holders to hold straps away from the child. Move shoulder straps to the side, remove child.

To remove the seat refer to page 70 for ISOFLEX or below for seatbelt installation.

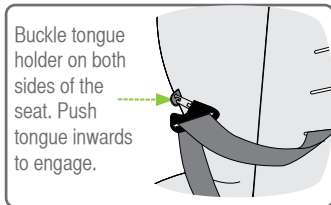

## REMOVE RESTRAINT FROM VEHICLE FITTED WITH SEATBELT

- A. Remove the top tether strap from pocket and fully press top tether adjuster button (1) while pulling top tether strap (2) to slacken as shown. In some vehicles loosening of the top tether strap may be difficult. If so, try pushing the restraint against the vehicle seat back or slightly lifting the restraint to release the tension.
- B. Disengage the attachment clip from upper anchorage fitting.
- C. Store loose strap in the top tether storage pocket provided on the cover.
- D. Disengage the vehicle seatbelt buckle from any lock-off devices on both sides of the restraint.
- E. Disengage seatbelt from the restraint belt paths. Allow seatbelt to feed back into seatbelt retractor.

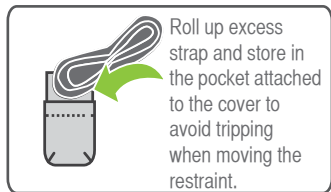
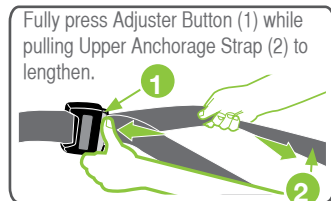

## DISCONNECT TOP TETHER AND ISOFLEX CONNECTORS

To store the ISOFLEX connectors on the inside of the seat wings.

- A. Press the ISOFLEX strap adjuster button to release tension on the straps.
- B. Press each of the red release buttons on the ISOFLEX connectors and remove them from the vehicle ISOFIX low anchorages.
- C. Fully lengthen the ISOFLEX strap and engage each ISOFLEX connector onto its storage pin. Remove slack but do not tighten. The storage pin may be damaged if the strap is tightened.
- D. Remove the excess tether strap from pocket and fully press top tether adjuster button (1) while pulling top tether strap (2) to slacken as shown. In some vehicles loosening of the top tether strap may be difficult. If so, try pushing the restraint against the vehicle seat back or slightly lifting the restraint to release the tension.
- E. Disengage the attachment clip from upper anchorage fitting. Roll up and store the loose top tether strap in the pocket provided on the cover to avoid tripping.

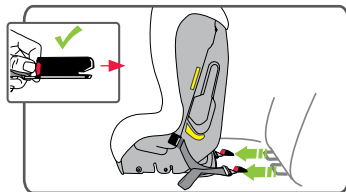

Storage Pin

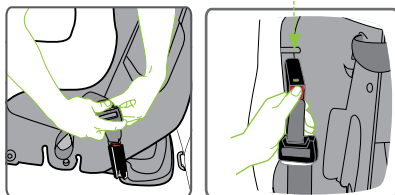

Fully press Adjuster Button (1) while pulling Upper Anchorage Strap (2) to lengthen.

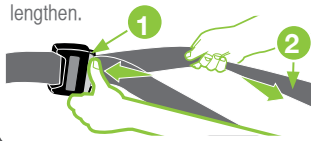

Roll up excess strap and store in the pocket attached to the cover to avoid tripping when moving the restraint.





**THIS RESTRAINT IS SUITABLE FOR USE ON AN AIRCRAFT WHEN INSTALLED AS DIRECTED.**

(AUSTRALIAN DOMESTIC FLIGHTS)

**HOW TO INSTALL USING AIRCRAFT LAP BELT**

**The child restraint must be used in accordance with the aircraft procedures, and any directions from the aircraft operator, pilot or crew.**

Inform the aircraft operator that a child restraint is intended to be used on the aircraft when booking the flight as the child restraint may not be suitable for use in that operator's aircraft.

Some child restraints may not fit in smaller aircraft and can not be used with aircraft seatbelts that contain airbags unless they can be disabled.

Follow the instructions of the flight crew or pilot.

For use of the child restraint in cars in countries other than Australia and New Zealand as follows:

(A) The child restraint may not be acceptable for use in cars.

(B) The user may need to consult the country's local authorities, car hire companies, car insurance companies, etc. for advice.

**TO FIT THE CHILD RESTRAINT TO THE AIRCRAFT SEAT IN FORWARD FACING:**

- A. Set the recline position to fully upright. Position the restraint in forward-facing mode and align centrally with the chosen seating position. We recommend that you fit the restraint nearest the window or in a middle seat if in centre seating area, so it will not interfere with an adult exiting the row of seats. If possible, lift the armrests out of the way to improve access to installing the aircraft lap belt. However airline staff will direct you to the desired seat position.

- B. The top tether is not required to be used to fit the child restraint in an aircraft. Shorten the top tether strap and store in its storage pocket. Attach the tether clip to the elastic loop provided on the restraint as shown.



### IMPORTANT:

When the tether hook is stored on the loop always remember to attach the upper tether strap when reinstalling in the car.

Store tether clip on elastic loop

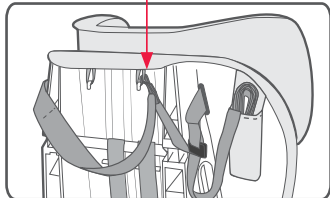

- C. Fully lengthen seatbelt. Thread the seatbelt into **AIRCRAFT SEATBELT PATH** - seatbelt path marker (green marker) as shown, ensuring that the seatbelt is behind the harness straps and below the hook as shown, on each side. Engage seatbelt buckle and tongue.

An extension seatbelt may be used to reposition the buckle to the side of the child restraint. Request from crew onboard the aircraft.

- D. Push down on the restraint and remove all slack from the seatbelt.
- E. Place child in the seat, fit the harness, engage buckle and remove the slack in the harness.

Ensure seatbelt is below the hooks on both sides

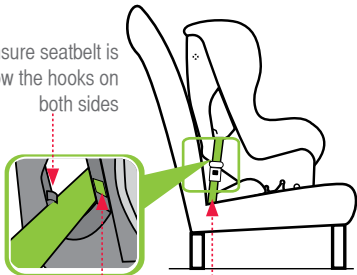

**AIRCRAFT SEATBELT PATH;** marked in green.

Aircraft seatbelt

Aircraft label is located on the back of the restraint and demonstrates suitability for use on an aircraft.



**This Child Restraint System meets the standards for use in aircraft as recommended by the Civil Aviation Safety Authority of Australia and the Civil Aviation Authority of New Zealand.**

**Only to be used on aircraft with the permission of the aircraft operator, pilot and crew.**

**SUITABLE FOR FORWARD USE**

**The top tether strap is not required to be used onboard aircraft and should be stowed securely.**

## REGULAR CARE OF THIS RESTRAINT:

Please check the following items regularly to ensure the safety of your child. Look for deterioration of:

- A. Check the webbing of the straps for fraying,
- B. Check there are no cracks in moulding,
- C. Check the harness adjuster is operating and is clamping the webbing,
- D. Ensure the buckle is free of fluff, liquid or other matter that may enter the buckle slots. Clean the buckle if it is sluggish to engage. See next page.

If any part of these parts show signs of deterioration, is cracked or broken, seek repair immediately - contact Britax Customer Service 1300 303 330

## CLEANING CAR SEAT

**HARDWARE:** Use only mild soap to clean all metal and plastic parts of your child's restraint, using a damp sponge or cloth. Do not use chemicals or cleaning agents. Do not try and place any hardware into a washing machine.

**STRAPS/HARNESS:** We recommend spot cleaning straps and harness with a damp sponge or cloth using only cold or warm water. Never place any straps or harness into a washing machine or tumble dryer.

## BUCKLE OPERATION

To ensure the buckle remains operational the inside of the buckle must be kept free of liquids, sand, dirt, fluff, food or similar substances. If the buckle is not operating or you do not hear a strong audible click when the second tongue is inserted then the buckle needs to be washed or replaced. The buckle is fully engaged when both tongues are inserted and a 'click' is heard. Contact Customer Service for assistance.

### TO CLEAN HARNESS BUCKLE:

If sticky liquids such as baby formula, fruit juice, etc. get inside your harness buckle, it may become sluggish. An indication of a sluggish harness buckle is that you cannot hear a click when engaging the last harness tongues. To restore the harness buckle to good working order it needs to be cleaned as follows:

- Remove the harness buckle from the restraint: From the underside of the restraint pull each crotch strap 3-bar slide, turn the 3-bar slide on its side and push back through the slot.
- Place the harness buckle under warm (max. 40 degrees Celsius) running water as shown below. Let the water run through the mouth of the buckle for five minutes. Check the harness buckle is clean by engaging the harness tongues and buckle several times until you hear a click.
- If you still cannot hear a strong audible click then repeat the cleaning process several times.
- Refit the harness buckle to the restraint ensuring the red button facing outwards and the 3-bar slide is fed through the same slots.

**If the Harness Buckle cannot be returned to its original working condition then contact BRITAX Customer Service for assistance.**

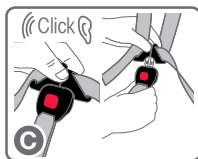
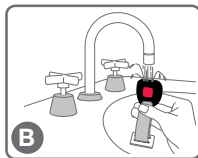
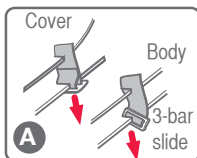

## COVER (STYLE MAY VARY)

The restraint has a flame retardant cover which is removable for cleaning. Cleaning instructions are on the care label attached to the cover. If a fluffy cover is fitted, washing cover prior to use should remove excess fluff.

Drying the padded insert will take additional time as the comfort foam will absorb moisture. Before washing re-engage any hook and loop on the cover and padded insert to prevent fabric damage. The cover has been designed to protect your child when seated in the restraint. Care should be taken if children either eat or drink while in the restraint as some food or drink products may cause damage or marking to the cover. Wash or clean immediately.

Do not pull sticky items from covers as the cover may be damaged - soak in water and gently remove.

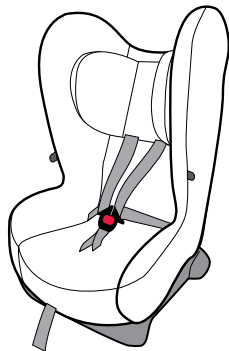

### **IMPORTANT:**

Do not pull sticky items from covers as the cover may be damaged - soak in water and gently remove.

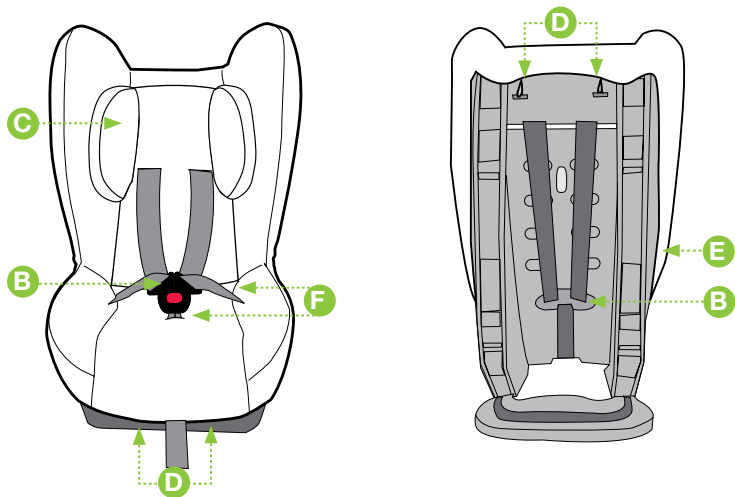

### TO REMOVE COVER

You do not have to completely remove the shoulder harness assembly from the restraint. However, you will need to disconnect the shoulder harness straps from the metal strap connector at the back of the restraint. Follow the sequence below A to G to remove the cover.

- A. Disengage harness tongues from harness buckle.
- B. Disconnect shoulder harness straps from metal strap connector at the rear (page 43 or page 66). Pull the shoulder straps out of the shoulder strap slots in the headrest. Remove any accessories such as padded insert, shoulder pads and crotch pad (if supplied).
- C. To remove headrest cover, unclip any press studs fitted to the headrest and then remove headrest cover by lifting the elastic loops attached to the headrest cover and peeling away from headrest.
- D. To remove trim cover, unhook elastic loops at the upper rear of the seat and clips and/or elastic loops at the front of the seat.
- E. Release fabric overhang at the side of the seat.
- F. Carefully remove trim cover away from restraint while feeding through the crotch buckle, harness tongues and strap through the lap and crotch strap slots in the cover.



## TO REPLACE COVER

1. Align and fit trim cover over restraint starting at top. Attach elastic loops **D**.
2. Refit fabric overhang **E**.
3. Feed shoulder harness straps through the lap strap slots.
4. Feed crotch buckle through slot in cover and over harness adjuster strap whilst fitting the cover at the lower part of the seat.
5. Re-attach plastic clips at the front of the seat and elastic loops **F**.
6. Fit headrest cover over headrest, ensure elastic is at the rear of headrest and any press studs are re-attached to headrest cover.
7. Refit the harness strap by feeding through the appropriate shoulder strap slots. You **MUST** thread the shoulder strap over the cross bar and then re-attach the straps to metal strap connector at the back of the seat (see page 43 or 66).
8. Refit any accessories such as padded insert, shoulder pads and crotch pad (if supplied).
9. Ensure the harness straps are not twisted.

**ONLY USE BRITAX SAFE-N-SOUND SEAT COVERS AND ACCESSORIES THAT ARE DESIGNED AND TESTED FOR USE WITH THIS PRODUCT.**



### **VERY IMPORTANT:**

**Only replace the cover with Safe-n-Sound supplied replacement cover with identical shoulder height markers or a replacement cover meeting AS/NZS 8005.**

Use of aftermarket accessories, that is, accessories not provided with this child restraint can reduce the safety of the child restraint and may cause injury or death. Always follow the instructions covering the use of accessories in these instructions or the instructions provided with the accessory. If an aftermarket accessory is used that is not recommended by Britax then ensure that the accessory is for this restraint and compliant with AS/NZS 8005 and is stated as suitable for use with this child restraint.

The following instructions apply to accessories that may be supplied with this restraint at point of purchase. If not, a variety of Britax Safe-n-Sound accessories are available from various retailers of Britax Safe-n-Sound products.

### SHOULDER PADS (If supplied)

Shoulder pads are designed to provide extra comfort for baby or child and are easily fitted to the shoulder harness straps by use of the press studs. The pads are positioned on the shoulder strap with the press studs away from the child's neck. Shoulder pads are positioned beside the child's or baby's neck.

### CROTCH PAD (if supplied)

The crotch pad is designed to provide extra comfort for baby or child and is fitted to the crotch buckle straps. It can be removed when the buckle is disengaged.

### POCKETS (if fitted to the cover)

The pockets sewn on the trim are designed for your convenience. They can hold those necessary items that you need at a moments notice. e.g Bottle, face washer, toy etc.



### CAUTION:

If using a pocket to store filled bottles, please ensure contents are not contaminated due to prolonged storage. Ensure contents are not crushed by car door when closing.

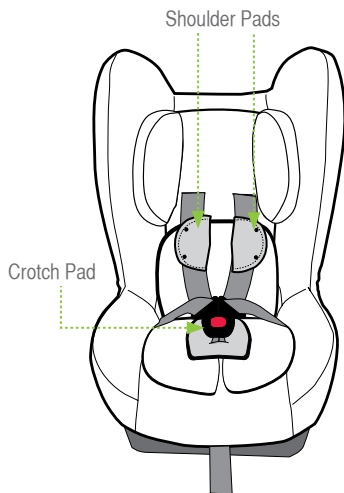

**SEAT PROTECTOR (if supplied)**

Place ribbed or pocket end of the seat protector on edge of car seat, smooth back toward seat join ('A') and fit in any excess into the join of the car's seat ('A'), or for the long seat protector lay up the back of the vehicle seat.

**⚠ CAUTION:**

If using a pocket to store filled bottles, please ensure contents are not contaminated due to prolonged storage. Ensure contents are not crushed by car door when closing. The pocket is only for small, light items. **DO NOT** overload the pocket with heavy, bulky items as this may damage the pocket or cause passengers to trip over them.

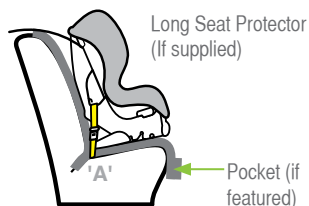
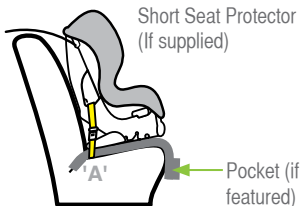

NOTE: Some seat protector may not have pockets.

**PADDED INSERT (if supplied)**

Your restraint will be supplied with a padded insert which is designed to snugly support your baby.

Discontinue use if the padded insert is a tight fit or creates discomfort.

The padded inserts are not suitable for forward facing use.

Fit as follows:-

- A. Disconnect buckle and place insert under shoulder and lap straps.
- B. Feed the crotch strap through the flap in the padded insert and re-connect buckle.

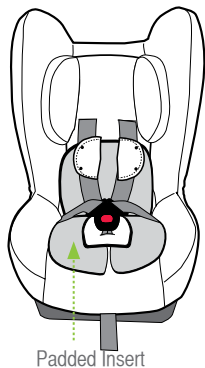

**CUP HOLDER (If supplied)**

The cup holder can be fitted onto either side of the seat.

- A. Raise the cover and locate fixing slots in shell.
- B. Clip cup holder into position, then re-fit cover.  
Ensure the cup holder and its contents cannot be crushed by the car door. Remove or reposition the cup holder to the opposite side as required.

**NOTE:** Only use for holding cups and bottles.

Ensure cup holder and contents are not crushed by car door when closing.

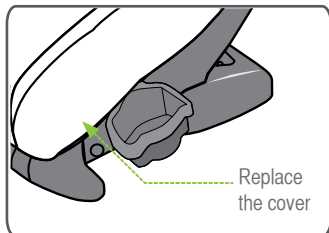
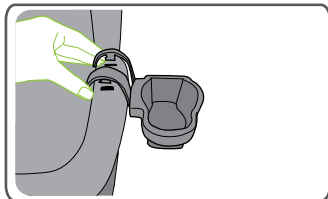
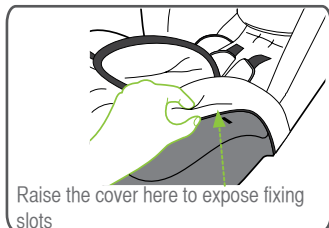

Consult the vehicle owner's handbook for location of anchorage fittings or anchorage points and the possible use of spacers. Some vehicles may have an anchor fitting fitted by the vehicle manufacturer. If anchorage points cannot be found refer to car manufacturer or local child restraint fitting station or traffic authority for optimum position of upper anchorage point and the use of spacers.

## TOP TETHER STRAP



### **IMPORTANT:**

THE ATTACHMENT CLIP COVER MUST ALWAYS BE USED AS IT PREVENTS THE RISK OF INCORRECT FITMENT OF THE ATTACHMENT CLIP TO THE UPPER ANCHORAGE POINT. BEFORE EACH USE OF THE RESTRAINT ALWAYS ENSURE THAT THE ATTACHMENT CLIP IS CORRECTLY ENGAGED TO THE UPPER ANCHORAGE POINT AND NOT HOOKED TO OR FITTED TO, ANY OTHER OBJECT. THIS IS ESPECIALLY IMPORTANT IN VEHICLES SUCH AS STATION WAGONS, VANS, HATCH BACKS OR VEHICLES WITHOUT A FIXED PARCEL SHELF, SINCE THE ANCHOR POINT IS USUALLY NOT VISIBLE.

## **IMPORTANT INSTALLATION NOTE:**

In some vehicles the upper anchorage point in the rear vertical panel can only be installed in one way. Please refer to vehicle owner's handbook or a child restraint fitting station for correct method.

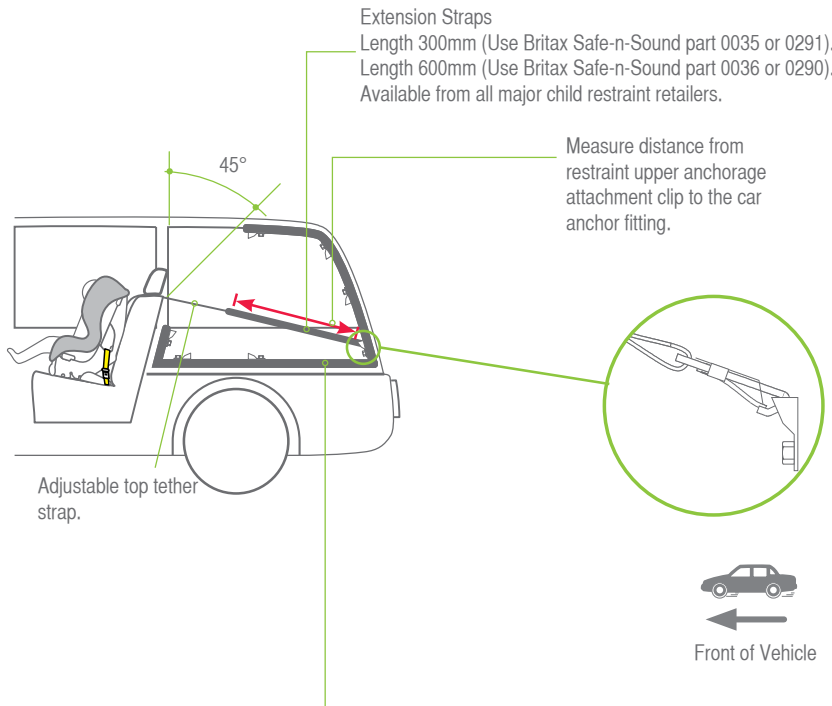

The shaded areas of this diagram illustrate the possible locations of the upper anchorage point (car anchor fitting). Within each shaded area is an upper anchorage point showing the correct way to install the fitting. Ensure the upper anchorage point is aligned as illustrated unless stated otherwise in the vehicle owner's handbook.

## IF THE CAR IS FITTED WITH CHILD RESTRAINT UPPER ANCHORAGE POINT

Locate the upper anchorage point behind the rear seating position. (Consult the car owners handbook for the location of the upper anchorage point). The upper anchorage point should be directly behind and central to the restraint. Remove thread plug from the parcel shelf/floor/roof, etc. and install attachment bolt and fitting as shown in Fig 1.

**CAUTION: DO NOT OVERTIGHTEN ATTACHMENT BOLT. OVERTIGHTENING MAY FRACTURE OR BREAK BOLT. MAXIMUM TORQUE IS 20 Nm(14.75 ft.lb.)**

Note: Minimum of five full turns of attachment bolt is required before tightening force is applied.

## IF THE CAR IS NOT FITTED WITH CHILD RESTRAINT UPPER ANCHORAGE POINTS

**For Sedans only** - Drill 9mm diameter hole in the parcel shelf on the centre line of the seating position as shown in Fig 3. Before drilling the hole, check the underside for accessibility. Install the attachment bolt as shown in Fig 2. It is recommended that this installation be carried out by a child restraint fitting station or licenced motor mechanic.

**For vehicles other than Sedans** - In Australia, consult your nearest child restraint fitting station or traffic authority for vehicle inspection to find the best, correct position for the placement of the upper anchorage point, and for the correct attachment bolt length and use of spacers. In New Zealand, consult the agent for the vehicle. Note to Queensland purchasers: The installation of anchorage points must be approved by authorised officers appointed by Queensland Transport. Authorised officers can be sourced from all Queensland Transport Customer Service and Queensland Ambulance Service Centres.

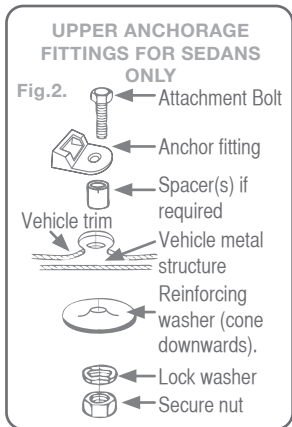
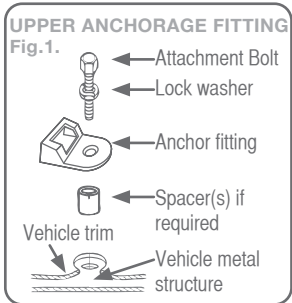

ONLY USE A 5/16 UNC GRADE 5 BOLT. IF THE BOLT IS NOT THE CORRECT LENGTH THE CAR MANUFACTURER'S HAND BOOK CAN PROVIDE ADVICE ON THE CORRECT LENGTH BOLT.



NOTE: Marking on the top of a Grade 5 Bolt. Do not use any bolt without these marks.



## WARNING

CHILD RESTRAINTS MUST NOT BE ATTACHED TO UNSOUND METAL OR TO WOOD, OR SYNTHETIC STRUCTURES. WHEN DRILLING 9 MM HOLE DO NOT DRILL THROUGH FUEL LINES, FUEL TANKS, ELECTRICAL WIRING, OR RADIO SPEAKERS. WEBBING STRAPS MUST BE PROTECTED FROM SHARP CORNERS AND EDGES. THE ANCHOR FITTING MUST BE USED ONLY AS DESCRIBED ABOVE. IT MUST NOT BE HOOKED ONTO ANY OTHER OBJECT.



Front of vehicle

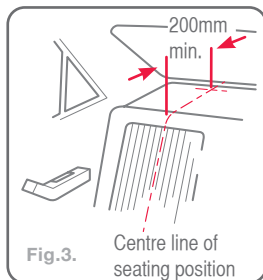

Fig.3.

Centre line of seating position

## CAR INSTALLATION ACCESSORIES (From retailers of Britax Safe-n-Sound products)

EXTRA ANCHOR KITS: Available for using the restraint in additional cars.  
Re-order no: 0038 or 0289

EXTENSION STRAPS: May be required for cars without a fixed parcel shelf.  
Re-order no: 0035 or 0291 (length 300mm) or  
0036 or 0290 (length 600mm)



## SAFETY

Never hold a baby in arms when riding in a motor vehicle. In this position the baby could be thrown against the dashboard, windscreen or other occupant and suffer serious injury or death.

When riding in a motor vehicle never nurse a baby and use the same seat belt for both of you. In this position the baby or child could be crushed.

Never breast feed a baby while car is in motion.

Children must be secured in appropriate restraints at all times when the car is in motion. Children travelling unrestrained and standing up in the car are in danger of serious injury or death. Traffic regulations in all states require children to be secured in child restraints or adult seat belts where available.

Plan your trip with frequent comfort stops to reduce stress on babies, young children and driver. Keep the car well ventilated to reduce heat stress. Car windows should be kept open to maintain a good flow of fresh air.

Never leave babies or toddlers in a stationary car because of the risk of heat exhaustion.

Ensure babies and toddlers are adequately shaded from direct sunlight through side or rear windows.

Check the car is ventilated by opening windows or using the car's ventilation system taking in external air. Recirculation setting is not suitable for providing ventilation.

Be on guard against carbon monoxide poisoning which can occur through only a slight leak in the exhaust system while travelling in a closed car.

Securely stow all heavy objects, feeding bottles, etc. that could become missiles during an accident and cause injury to any occupant.

## CLOTHING/BATHING

Since it is often warmer in the car, dress the baby in light clothing.

Do not harness an infant wrapped in a blanket or swaddled. Any blanket or wrap must only be placed over the harness and infant.

If your restraint has been involved in a severe crash, you should destroy the restraint even if no damage is obvious. Some insurance companies offer vehicle insurance which covers or partially covers the replacement of your child restraint. Contact your insurance company for further details. Your insurance company may require you to keep the child restraint for assessment, **but do not use the child restraint after a severe crash**. To assist you in making an accident insurance claim cut the following statement and include it with your claim.

**NOTICE TO INSURANCE COMPANY CHILD  
RESTRAINT INVOLVED IN AN ACCIDENT**

All Britax Safe-n-Sound child restraints are manufactured to Australian/New Zealand Standards AS/NZS1754-2013 which require us to advise users of child restraints to "Destroy the entire restraint if it has been in use in a severe crash, even if no damage is obvious". The joint Australian/New Zealand Standards committee CS/85, advise that this statement applies whether a child was in the child restraint or not. A severe crash, we consider as being one where the main body structure of the vehicle is distorted.

There is no method of determining if the restraint has been damaged and we concur with the Australian/New Zealand Standards in recommending destruction of the child restraint.

This notice is to advise you of the requirements of the Australian/New Zealand Standards and our obligation in complying with the standards.

Please assist the owner of this restraint in their claim.

**Britax Childcare Pty. Ltd.**

(Incorporated in Victoria)

A.B.N 55 006 773 600

Head office and registered address:

Level 4, 650 Lorimer Street, Port Melbourne, VIC, 3207

P.O. Box 5119 Garden City, VIC, 3207

Telephone: 1300 303 330

New Zealand Office:

Britax Childcare NZ Limited,

PO Box 100-247 Auckland 9

Telephone: 0508 688 822



## CRASH EXCHANGE

We would never want you to experience an accident, but unfortunately accidents do happen.

If you experience an accident you may be eligible for a free replacement.

The Britax Safe-n-Sound Crash Exchange Program is a voluntary program designed to ensure that our children are safe and that any seat that may have experienced a severe crash is taken out of the market.

There is no method of determining if the restraint has been damaged in a severe crash, so the restraint should be destroyed as the crash may reduce the child restraints ability to perform.

Since its inception in 2006, the Crash Exchange program has helped 100's of families ensure that their children have new restraints and that the restraints are not sold second hand placing others at risk.

Our Crash Exchange Terms and Application form are accessible on our website. Please visit [www.britax.com.au](http://www.britax.com.au) for further information.

### AUSTRALIA

Britax Childcare Pty. Ltd.  
A.B.N 55 006 773 600

#### Head office and registered address:

Level 4, 650 Lorimer Street, Port Melbourne, VIC, 3207  
P.O. Box 5119 Garden City, VIC, 3207

**Customer Service** 1300 303 330

**Email** [au-support@britax.com](mailto:au-support@britax.com)

**www.britax.com.au**

### NEW ZEALAND

Britax Childcare (NZ) Ltd.  
**Customer Service** 0508 688 822  
**Email** [nzoffice@britax.com](mailto:nzoffice@britax.com)  
**www.britax.com.nz**

### INTERNATIONAL ENQUIRIES

Contact your local Distributor





Series No. BS0072E-i20133  
Series No. BS0072E-020133  
Series No. BS0072K-020133  
Scan QR code for features,  
how to use and installation.

britax  
safe·n·sound

## WARRANTY

Our goods come with guarantees that cannot be excluded under the Australian Consumer Law. You are entitled to a replacement or refund for a major failure and compensation for any other reasonable foreseeable loss or damage. You are also entitled to have the goods repaired or replaced if the goods fail to be acceptable quality and the failure does not amount to a major failure.

For the full terms of the Warranty refer to the Britax website [www.britax.com.au/service-support/warranty](http://www.britax.com.au/service-support/warranty)

The Safe-n-Sound trademark, ISOFLEX and product names are the property of Britax Childcare Pty. Ltd. (Australia).

The Britax trademarks are the property of Britax Childcare Holdings LTD, UK.

We reserve the right to alter this product without notice.

© 2007-2018 Britax Childcare Pty. Ltd. This product is covered by Australian and overseas

Patent applications. Patents pending.

P/No.2203168/C