

## GUIDELINES FOR SAFE DRIVING

1. Before children use this vehicle, an adult should carefully evaluate the driving area as well as the child's ability to drive the vehicle safely. Teach appropriate safety rules to your child before allowing operation of this vehicle. These rules should also be reviewed with other children who want to drive the vehicle.
2. Remain seated. A child who is not sitting on the seat when the vehicle is in motion could fall or cause the vehicle to tip over.
3. Do not operate the vehicle at night.
4. Do not operate the vehicle near steep inclines as it can cause the following:
  - Unsafe speed, even if the pedal is released.
  - Tipping
  - Loss of traction, causing the vehicle to slip.
  - Rolling backwards at an unsafe speed.
5. Avoid contact with moving/rotating parts, such as the motor, gear box, and wheels. Contact with these parts can cause serious injury.
6. Do not operate the vehicle when it's positioned on its side or upside-down.
7. Do not operate the vehicle near flammable vapors (gasoline, paint thinner, acetone, liquid wax, etc.) as the electrical switch emits an internal spark, which could cause an explosion or fire.
8. To prevent unsupervised use of the vehicle, remove the battery.

## VEHICLE CARE

### MAINTENANCE INSTRUCTIONS

1. It is the responsibility of the adult who assembles this product to properly install all parts included in the carton. These instructions are valuable.
2. Check nuts and bolts often and tighten if necessary.
3. Any parts showing evidence of wear should be replaced immediately.
4. Check all screws and their protective coverings regularly and tighten as required. Check plastic parts on a regular basis for cracks or broken pieces.
5. During snowy or rainy weather, the vehicle should be stored inside.
6. Do not operate the vehicle in wet or snowy conditions.
7. Do not clean the vehicle by spraying with a hose. Water or moisture in the motors, battery, or electrical components can cause component failure.
8. To clean the vehicle use a dry cloth. A non-wax furniture polish can be used to clean plastic. Do not spray the vehicle with a hose or submerge in water.
9. Risk of fire-Do not Bypass. Replace only with new Kalee Components by Adults.

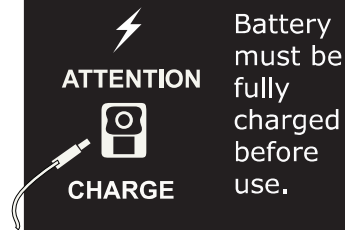

## 6V Spider-Man Quad Ride On

Keycode: 43064212 Model# KL-40051

**IMPORTANT! THIS PRODUCT SHOULD ALWAYS BE USED UNDER ADULT SUPERVISION.**

**IMPORTANT! IF YOU FIND EXTRA HARDWARE ITEMS, PLEASE DISPOSE OF THEM AND KEEP THEM AWAY FROM SMALL CHILDREN. IMPORTANT! PLEASE READ THIS INSTRUCTION MANUAL BEFORE ASSEMBLING THE PRODUCT.**

**ALL ASSEMBLY SHOULD BE COMPLETED BY AN ADULT.**

**KEEP THE INSTRUCTIONS AS IT CONTAINS IMPORTANT INFORMATION.**

- 1) Warning: Do not recharge non-rechargeable battery.
- 2) During charging, the battery must be placed in a well ventilated area.
- 3) The battery charger used with the electric toy shall be regularly examined for damage to the supply cord, plug, enclosure or other parts, and in the event of damage, it shall not be used until the damage has been repaired.
- 4) The supply terminals are not to be short-circuited.

Age: 2-4 years



6V



## BATTERY WARNINGS:

### ⚠ DANGER:

To prevent electric shock, do not immerse in water; wipe clean with a damp cloth.

### ⚠ CAUTION:

Use the charger in dry locations only.

### BATTERY CARE:

- The battery must be handled by adults only. The battery is heavy and contains sulfuric acid.
- If the battery begins to leak, avoid contact with the leaking acid and place the battery in a plastic bag. If acid comes in contact with skin, eyes, or is internally ingested contact a physician immediately. See section titled "Battery Disposal" for proper disposal instructions.
- Never allow the battery to discharge completely. Battery should be charged before it is completely drained.
- Charge the battery before storing the vehicle.
- Fully charge the battery at least once per month, even if the product hasn't been used. Leaving the battery in a discharged state can shorten the life of the battery.
- Charge the battery after each use, regardless of how long the vehicle was used.
- Store the battery in temperatures between 35 °F (1.7 °C) and 77 °F (25.0 °C) for optimal performance.
- Never charge the battery longer than 12 hours. Failure to follow these instructions may damage your battery.

## BATTERY SPECIFICATION:



IMPORTANT! THIS PRODUCT SHOULD ALWAYS BE USED UNDER ADULT SUPERVISION.  
This item may only be used with a rechargeable 6V 1.3Ah. battery and 6V battery charger.  
Battery Type: Sealed lead-acid rechargeable, 6Volt 1.3Ah  
Power input for Charger: A/C 100-240 Volts, 50/60 Hz  
Power output to Battery: DC 7.5Volts, 350mA  
(Use only with provided switching adaptor IVP0750-0350WS).

--- ONLY CHARGE THE BATTERY IN A WELL-VENTILATED AREA AWAY FROM HEAT SOURCES AND FLAMMABLE MATERIALS.



### WARNING:

- The battery contains corrosive acid that can cause blindness or burns. Contact physician immediately if exposed.
- Keep out of reach of children.
- Do not open battery.



### DANGER/POISON:

### TO PREVENT FIRE, EXPLOSIONS OR SERIOUS INJURY

- Read the safety instructions on the battery.
- Examine the battery, charger, and all connections for excessive wear or damage before each use. Do not use if damage or wear is found. Replace immediately.
- Always secure the battery using the battery retainer.
- Only carry the battery by holding onto the main casing.
- Never modify the electrical system.
- Use only Kalee battery and charger specifically meant for this product.
- Do not use Kalee components in other battery operated vehicles/toys.
- Do not touch motor after prolonged periods of use. Motor housing may be hot. Handle carefully.
- Rechargeable batteries are only to be charged by adults.

11

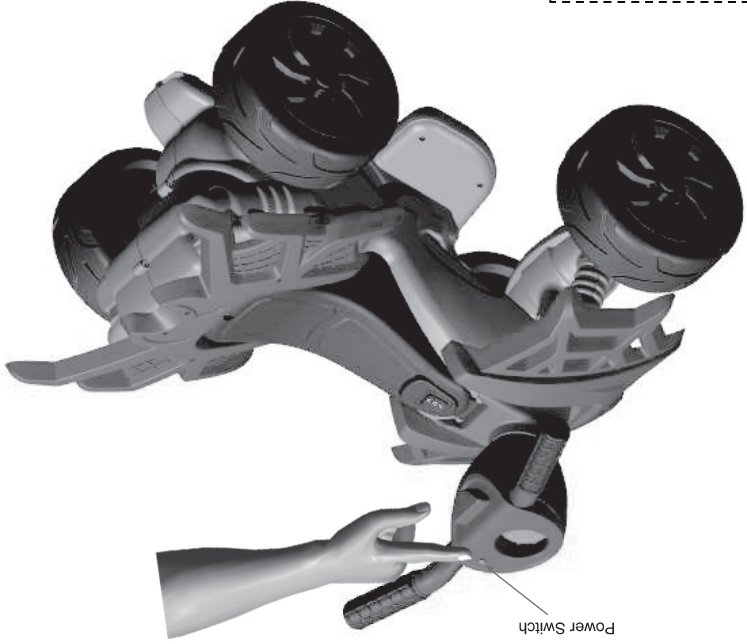

Power Switch

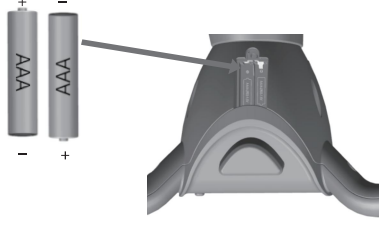
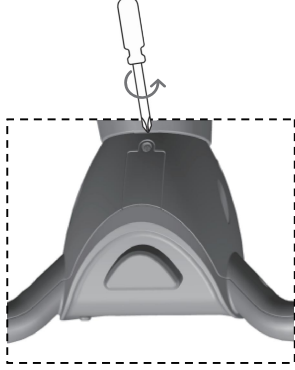

- The vehicle comes with headlight.
- The battery compartment located on the handlebar.
- Remove the retaining screws with screwdriver (not included) and open the battery compartment cover.
- Insert 2x"AAA" batteries (not included) into the battery cradle on the handlebar ensuring the polarity is correct.
- Replace the battery compartment cover and resecure the retaining screws.
- The 2x"AAA" batteries power the headlights. Press the black power switch on the turn on & turn off the headlight.

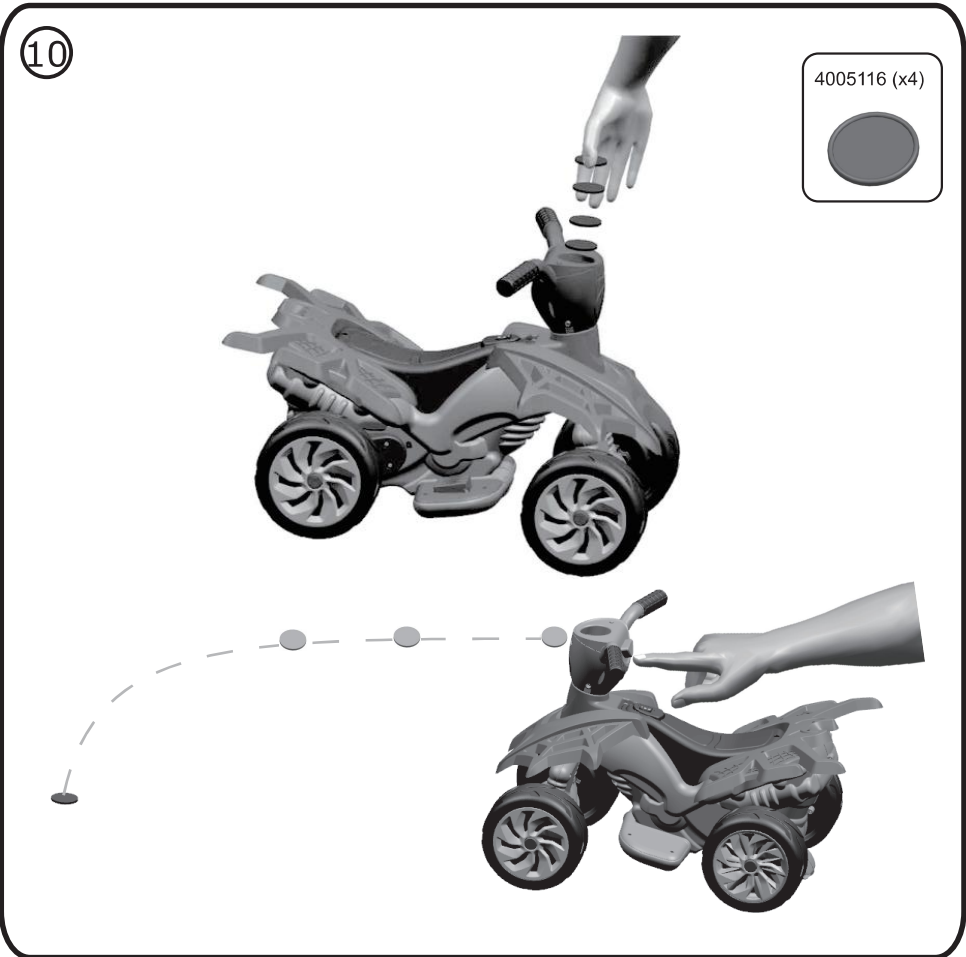
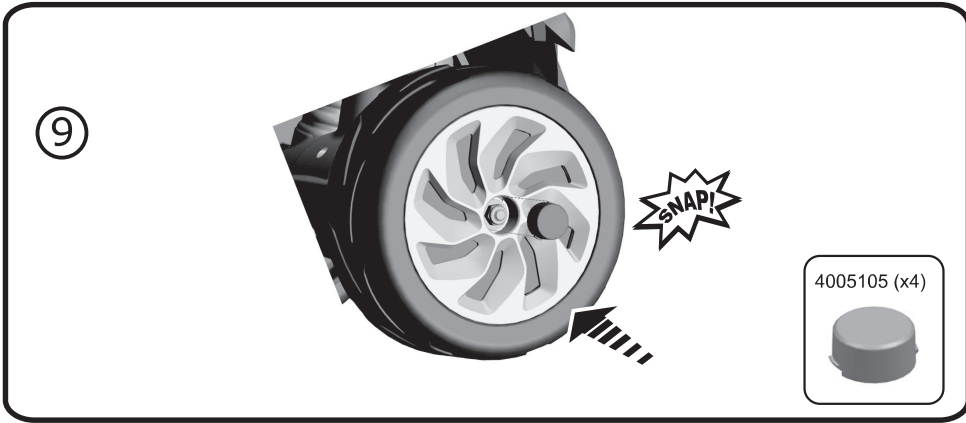

## BATTERY CHARGING

⚠ THIS SHOULD BE DONE BY AN ADULT.

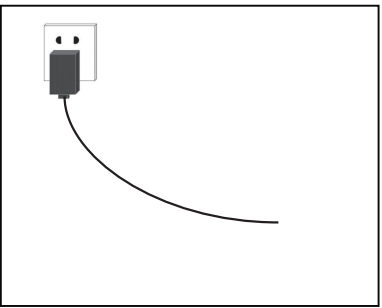
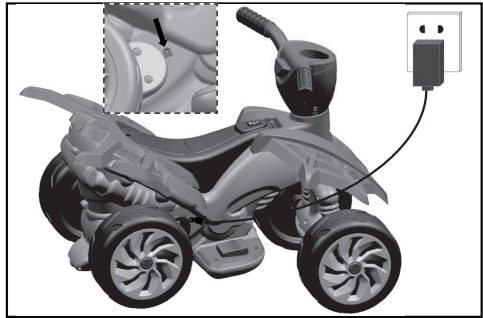

- Connect the DC plug to the body.
- Connect the charger to the mains.

- Only use the battery and charger specified by the manufacturer.
- The car can not be operated when the charger is connected to the car.



## BATTERY REPLACEMENT

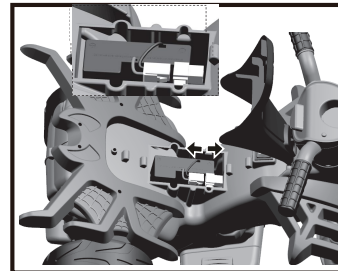

1. Unplug the white plug

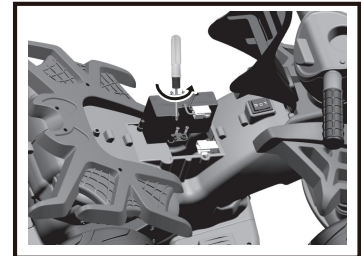

2. Undo the screw

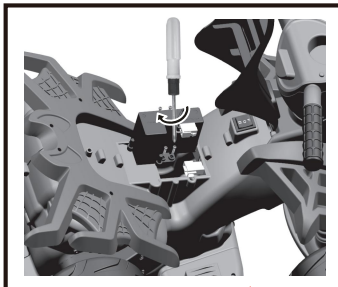

3a. Replace a new battery  
b. Tighten the screw

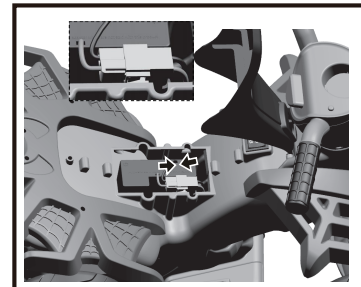

4. Connect the white plug

## ⚠WARNING

### TO AVOID SERIOUS INJURY:

- Continuous adult supervision required.
- Never use near motor vehicles, streets, swimming pools, hills, steps, or sloped driveways.
- Never allow more than one rider.
- Riders should always be seated.
- Always wear shoes.
- Maximum weight: 25 kg.
- Periodically check hardware and tighten if necessary.
- Replace worn or broken parts immediately.
- Rechargeable battery can only be recharged by an adult.
- Only use the battery and charger specified by the manufacturer.
- The car can not be operated when the charger is connected to the car.
- Never use or store in wet conditions.
- For use in large open areas. Avoid collisions.
- Skill is required to avoid falls or collision.
- Never ride at night.
- Protective equipment should be worn. Not to be used in traffic.

## PARTS BREAKDOWN

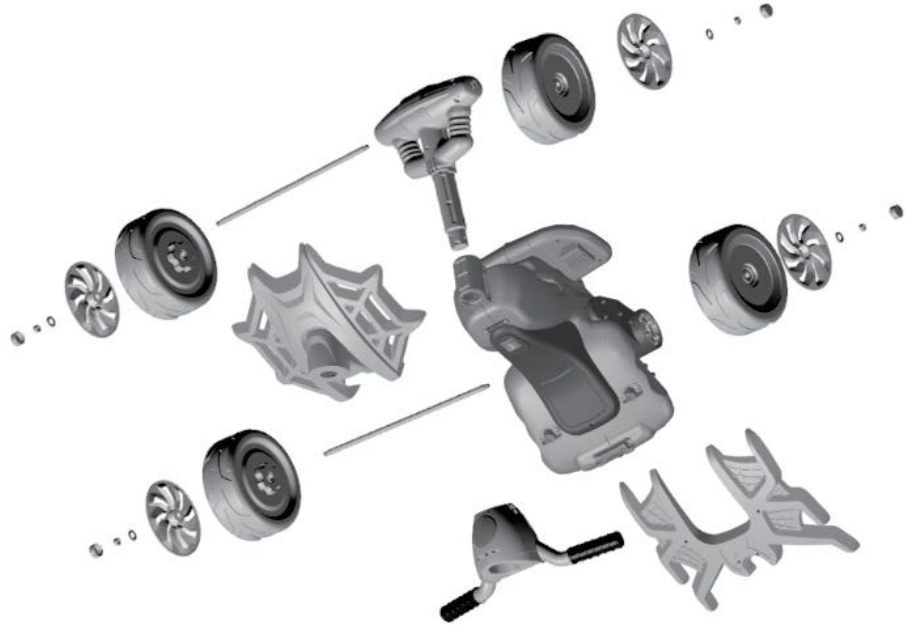

4

7

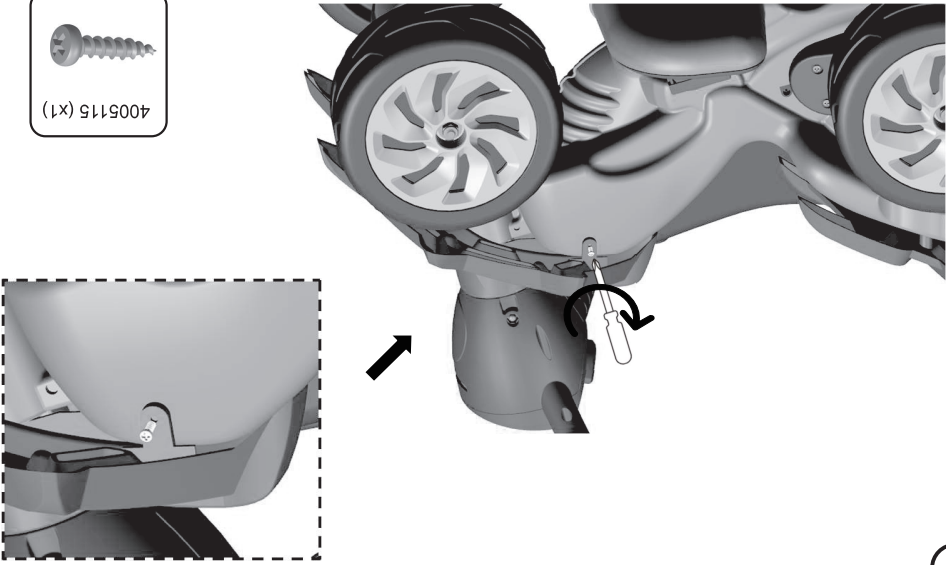

4005115 (x1)

8

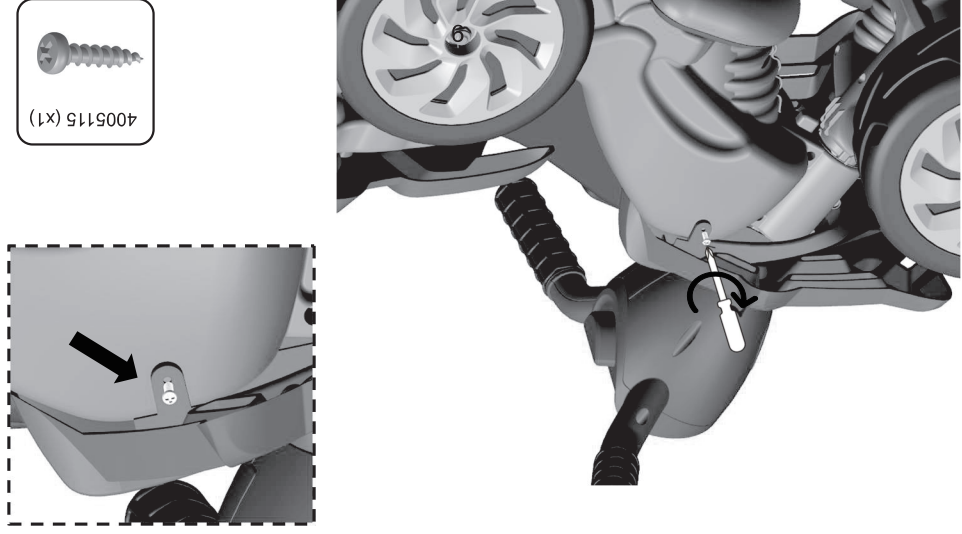





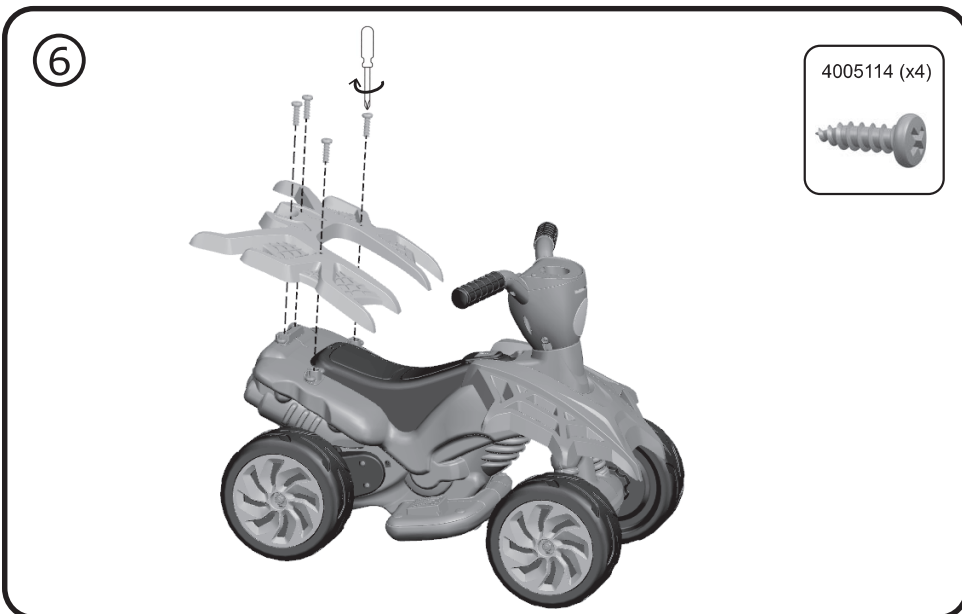
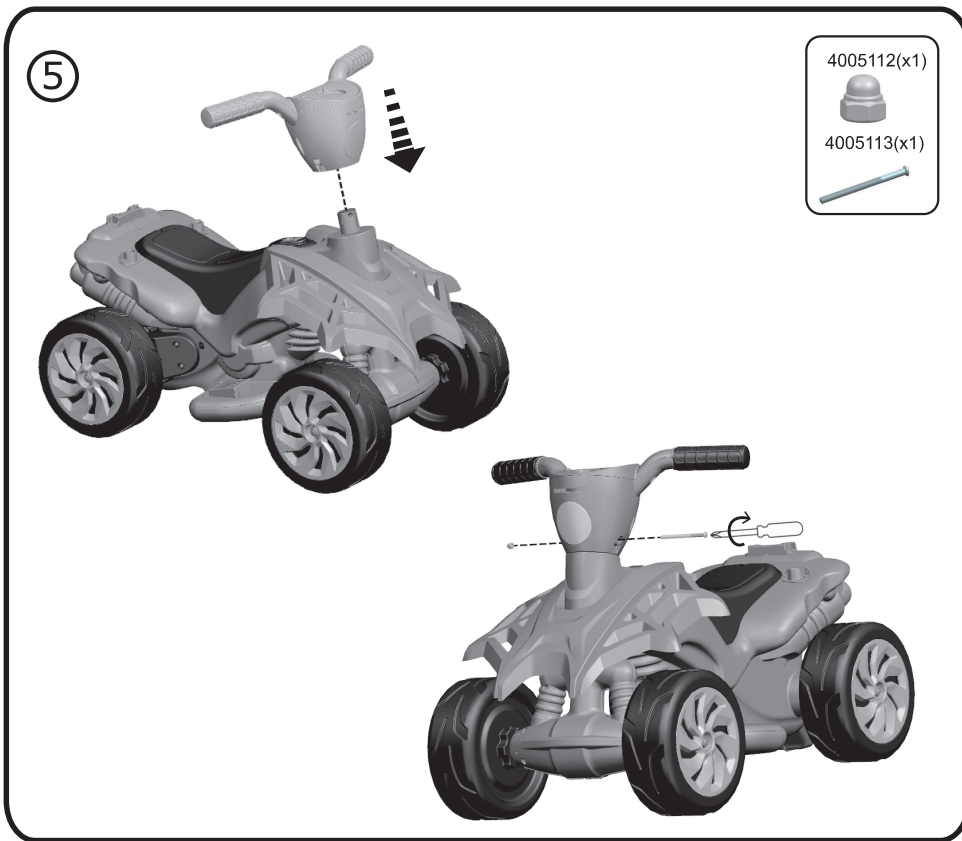











4005115 (x1)

9



## Parts List:

4005101(X1) Body 	4005102(X1) Front Fork 	4005103(X4) Wheel 	4005104(X4) Wheel Cover 	
4005105(X4) Wheel Cap 	4005106(X1) Front Body 	4005107(X1) Rear Body 	4005108(X1) 	
4005109(X2) Wheel Axle 	4005110(X4) Washer Φ20*10.5*2.0 	4005111(X4) M8 Nut 	4005112(X1) M5 Dome Nut 	4005113(X1) Screw PM5*70*8 
4005114(X4) Screw PA3.5*10*5.5 	4005115(X2) Screw PA3*16*5 	4005116(X4) Projectile (installed in the launcher) 	4005117(X1) Charger 	4005118(X1) Sticker sheet 

## Tools Required: (not included)

Screwdriver

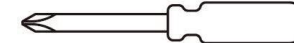





## Included:



4005119(X2)  
Wrench

**Spare Hardware (for future use): Please keep them away from small children.**

4005112(X1) M5 Dome Nut 	4005111(X1) M8 Nut 	4005110(X3) Washer Φ20*10.5*2.0 	4005114(X2) Screw PA3.5*10*5.5 
---	--	--	---

## ⚠ WARNING:

**ADULT ASSEMBLY REQUIRED.**

Choking hazard to children under the age of 3 years – contains small parts prior to assembly. All fasteners should be fully tightened. Children should not handle parts, including the battery and electrical components, or help with assembling the vehicle.

Please keep instructions for future reference.

