

# Geo High Low Highchair

## Instruction Manual

**6-36**  
months

**15**  
kg

MAXIMUM  
WEIGHT  
OF CHILD

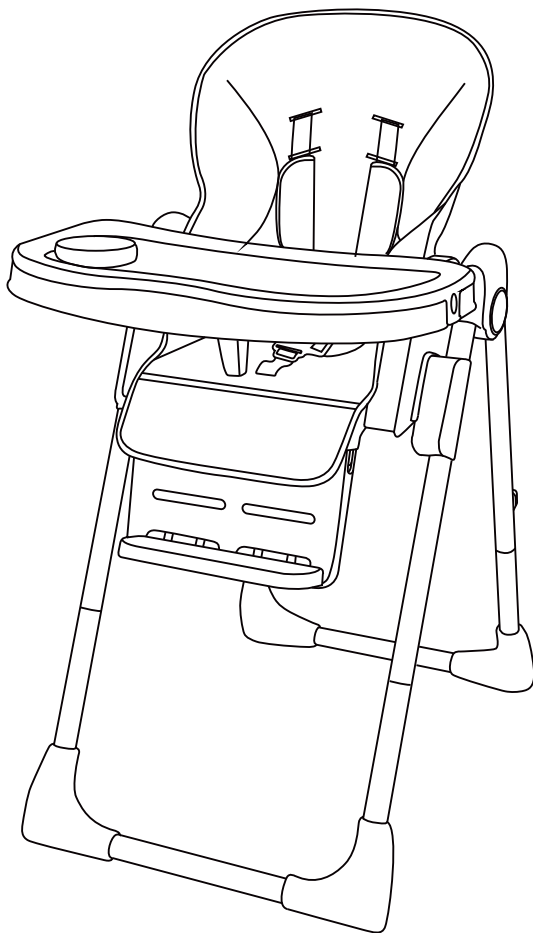

**THE ILLUSTRATIONS SHOWN IN THIS MANUAL ARE FOR REFERENCE ONLY. THE MANUFACTURER RESERVES THE RIGHT TO CHANGE ANY SPECIFICATION OR FEATURE WITHOUT FURTHER NOTICE. IMPORTANT! PLEASE READ CAREFULLY BEFORE USE AND KEEP FOR FUTURE REFERENCE.**

## Safety Advice

# **WARNING!** **IMPORTANT: READ CAREFULLY AND RETAIN THESE INSTRUCTIONS FOR FUTURE REFERENCE.**

Read these instructions carefully before assembly and use and keep for future reference. The child may be hurt if you do not follow these instructions. Adult assembly required.

Before using, remove and dispose of any plastic bags and other packaging (e.g. fasteners, fixing ties, etc.) and keep them out of reach of children.

**WARNING!** FOLLOW THE MANUFACTURER'S INSTRUCTIONS.

**WARNING!** Do not leave the child unattended. Always keep child in view while in the highchair.

**WARNING!** The product is intended for children able to sit up unaided and up to 3 years or a maximum weight of 15 kg.

**WARNING!** Do not use the highchair until your child can sit up unaided (approximately 6 months).

**WARNING!** Position the highchair away from solid structures and benches to avoid injuries caused by falls and by access to dangerous items.

**WARNING!** Do not use the highchair unless all components are correctly fitted and adjusted.

**WARNING!** Be aware of the risk of open fire and other sources of strong heat, such as electric bar fires, gas fires etc. in the vicinity of the highchair.

**WARNING!** Do not use if any part is broken, torn or missing.

**WARNING!** Do not move or carry the highchair with your child inside.

**WARNING!** THE HARNESS MUST ALWAYS BE USED AND CORRECTLY FITTED. MOST INJURIES FROM HIGHCHAIRS ARE CAUSED BY FALLS.

# Safety Advice

**WARNING!** Falling hazard: Prevent your child from climbing on the product.

**WARNING!** Be aware of the risk of tilting when your child can push its feet against a table or any other structure.

- › Assembly to be carried out by a competent adult only.
- › During assembly, children should be kept away from the product due to possible risk of injury.
- › Do not use this item if any components are missing or damaged.
- › Folding and unfolding this product should only be carried out under adult supervision.
- › Ensure that fingers and legs are clear of all adjustments when adjusting this product.
- › Regularly check all fastenings to ensure that they are properly tightened.
- › Use only on a level and stable surface.
- › Ensure children are clear of all moving parts before making any adjustments.
- › Do not use near stairs or steps.
- › When not in use, store away from children.
- › Use the highchair on a flat, even and horizontal floor and do not elevate the highchair on any structure or table.
- › To reduce the risk of injury, position the highchair away from furniture, walls, hot surfaces and liquids, window covering cords and electrical cords.
- › Position the highchair away from furniture when the chair is not being used at a table with the tray removed.
- › Regularly check all connections and / or fittings to ensure they are tight.
- › Do not use accessories or replacement parts other than those approved by the manufacturer.
- › Ensure all users are familiar with the products operation.
- › Ensure your highchair is fully erected before placing your child inside.
- › Do not allow your child to climb unassisted into, play with or hang onto the highchair. This is not a toy.
- › All additional hazards such as electrical flex should be kept out of the reach of children in the highchair.
- › When using the highchair at a table, ensure your child cannot push against the table or another surface as this could result in the chair tipping over.



Complies with EN 14988:2017+A1:2020; + AS4684 2009

# Parts List

## Check what you have received:

You have received 1 box. Please check the contents of the box against the list below. If anything is missing, please contact Customer Service.

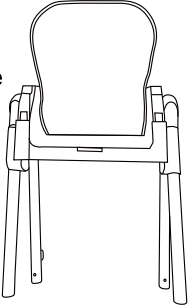
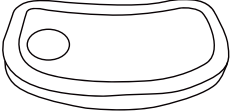
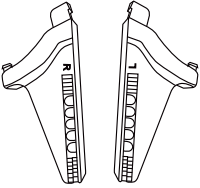
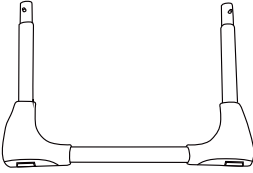
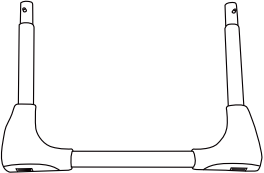
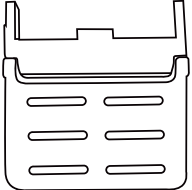
## Supplied in the box:

<p><b>A</b> x1 seat and frame</p> 	<p><b>B</b> x1 double tray</p> 	<p><b>C</b> x2 armrest</p> 
<p><b>D</b> x1 front feet with stoppers</p> 	<p><b>E</b> x1 rear feet with wheels</p> 	<p><b>F</b> x1 leg rest</p> 
<p><b>G</b> x1 footrest</p> 		

# Assembly

## Step 1

Assemble the feet (D) and (E) to the seat and frame (A).

**Please note:** ensure the feet with the feeding tray storage pegs are assembled to the rear of the highchair.

Each leg has a spring loaded pin. Line up one of the feet so that the small holes in the tops of the foot align with the spring pins.

Push firmly on the foot at either end until each of the 2 spring pins “click” into place. Repeat for the other foot.

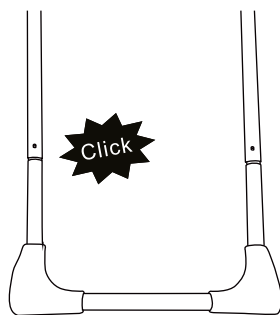
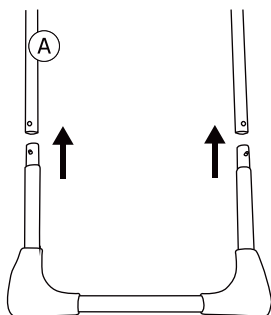
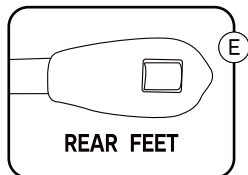
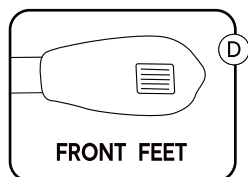

## Step 2

Open the seat unit and frame.

Press and hold the folding button and pull the rear legs out.

Release the button.

A “click” will signal when secure.

**WARNING! WHEN UNFOLDING THE HIGHCHAIR, ALWAYS CHECK TO ENSURE LEGS ARE FULLY OPEN AND THE LOCK IS ENGAGED BEFORE USE.**

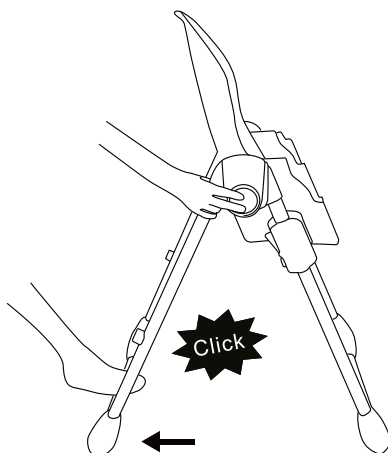
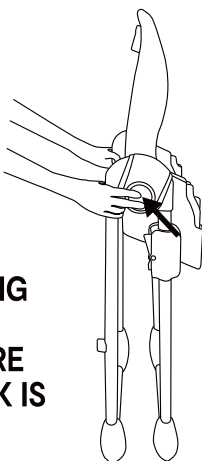

# Assembly

## Step 3

Locate the armrests (C) and note their orientation. For assembly, the flat side should be facing inside the seat. Align the armrests with the seat and press down firmly. A “click” will signal when secure.

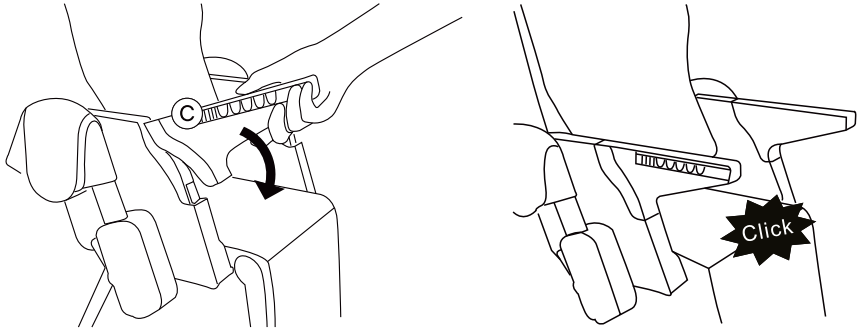

## Step 4

Attach the tray (B) to the seat. Pull outward on the levers found on the underside of the tray and slide the tray into position. Release the levers to lock the tray in place.

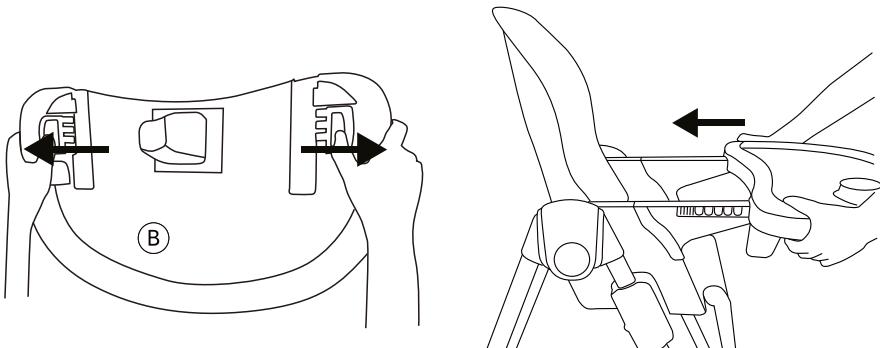

# Assembly

## Step 5

Insert the leg rest (F) into the holes as illustrated.

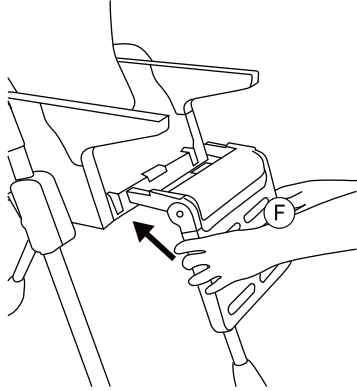

## Step 6

Attach the footrest (G) to the leg rest.

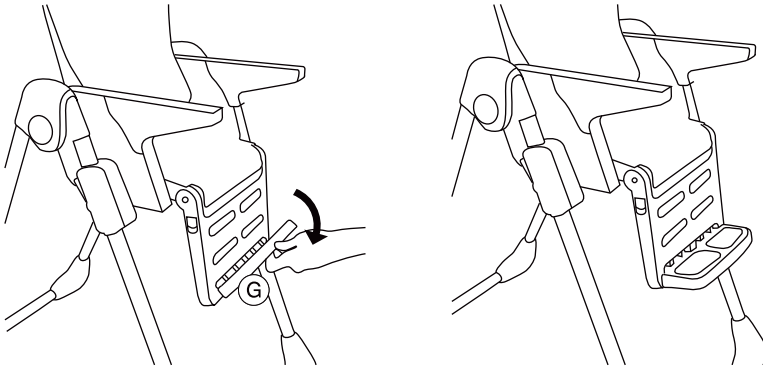

# Highchair Operation

## Height Adjustment

**WARNING! DO NOT ADJUST THE SEAT HEIGHT WHEN THE CHILD IS IN THE HIGHCHAIR.**

The highchair has 6 height positions. Simultaneously press in both height adjustment buttons to raise or lower the seat.

Release both of the locks at the required height.

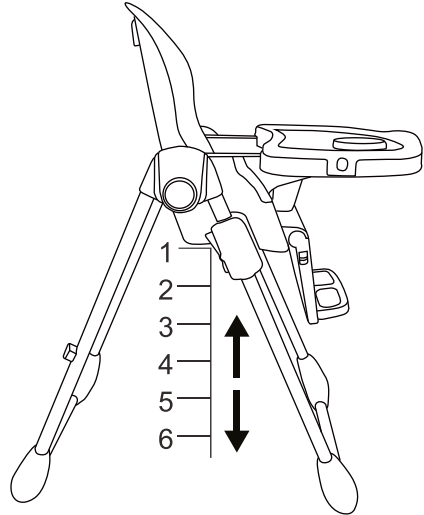
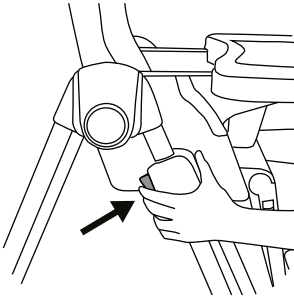

## Backrest Adjustment

The highchair has 3 backrest positions.

Pull up on the plastic lever found on the back of the seat and position the backrest as required. Release the mechanism to secure into place.

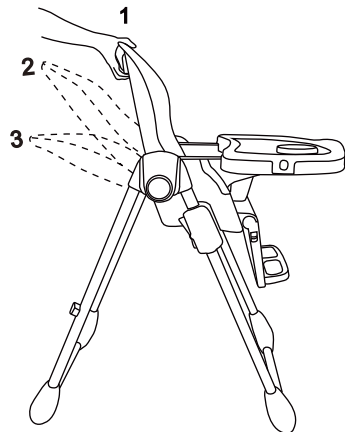
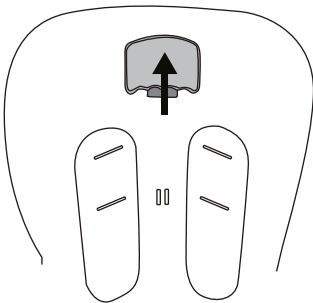



# Highchair Operation

## Leg rest Adjustment

The highchair has 3 leg rest positions. Simultaneously push down on the buttons found on both sides of the leg rest and position the leg rest as required. Release the buttons to secure into place.

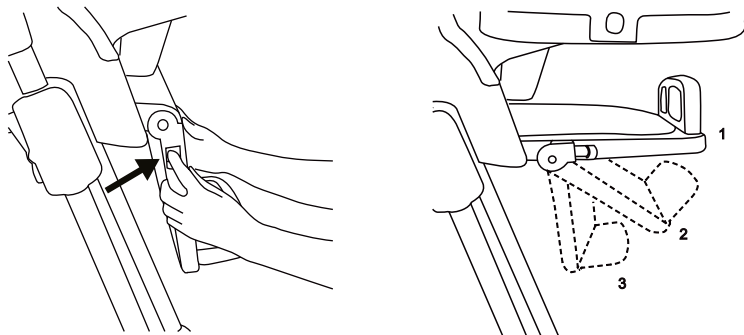

## Tray Adjustment

The tray has 3 positions. It will “click” when secured in desired position. The tray also has an inner snack tray. Pull up at the sides to remove snack tray from tray.

The tray can be stored on the rear of the highchair. Slide the tray connectors onto rear leg pegs and push down.

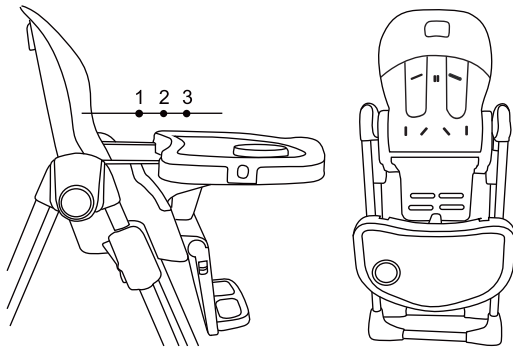

# Highchair Operation

## Harness Adjustment

**WARNING! ALWAYS USE THE HARNESS AND ENSURE IT IS CORRECTLY AND SECURELY FITTED WHILE CHILD IS IN THE SEAT.**

A 5-point safety harness is provided to restrain your child and should always be worn. To fasten the harness, push the prongs into the buckle housing. Listen for the “click” sound. To release, press the centre button and remove prongs from the buckle.

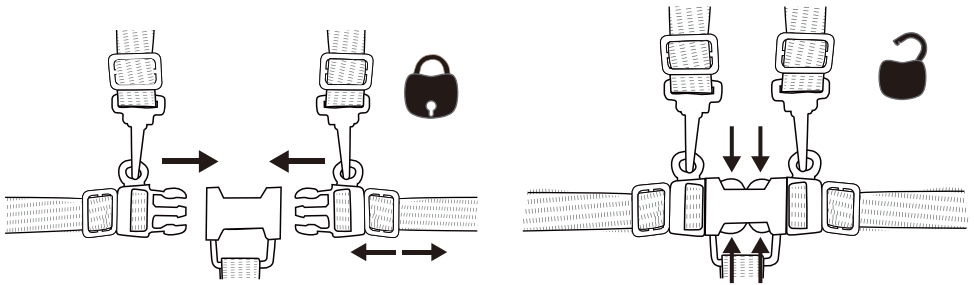

**WARNING! ALWAYS ADJUST THE HARNESS TO FIT YOUR CHILD CORRECTLY FOR THEIR COMFORT AND SAFETY. A LOOSE FITTING HARNESS CAN BE VERY DANGEROUS.**

Sliding adjusters are fitted and should be carefully adjusted so the harness fits your child comfortably.

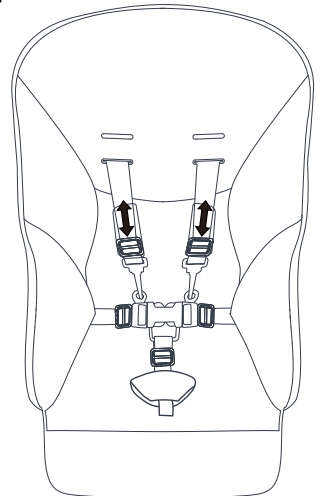

# Highchair Operation

## Harness Adjustment continued

The highchair has 2 shoulder height positions.  
To adjust the shoulder height position, pass the plastic ends of the harness through the horizontal slots in the backrest.

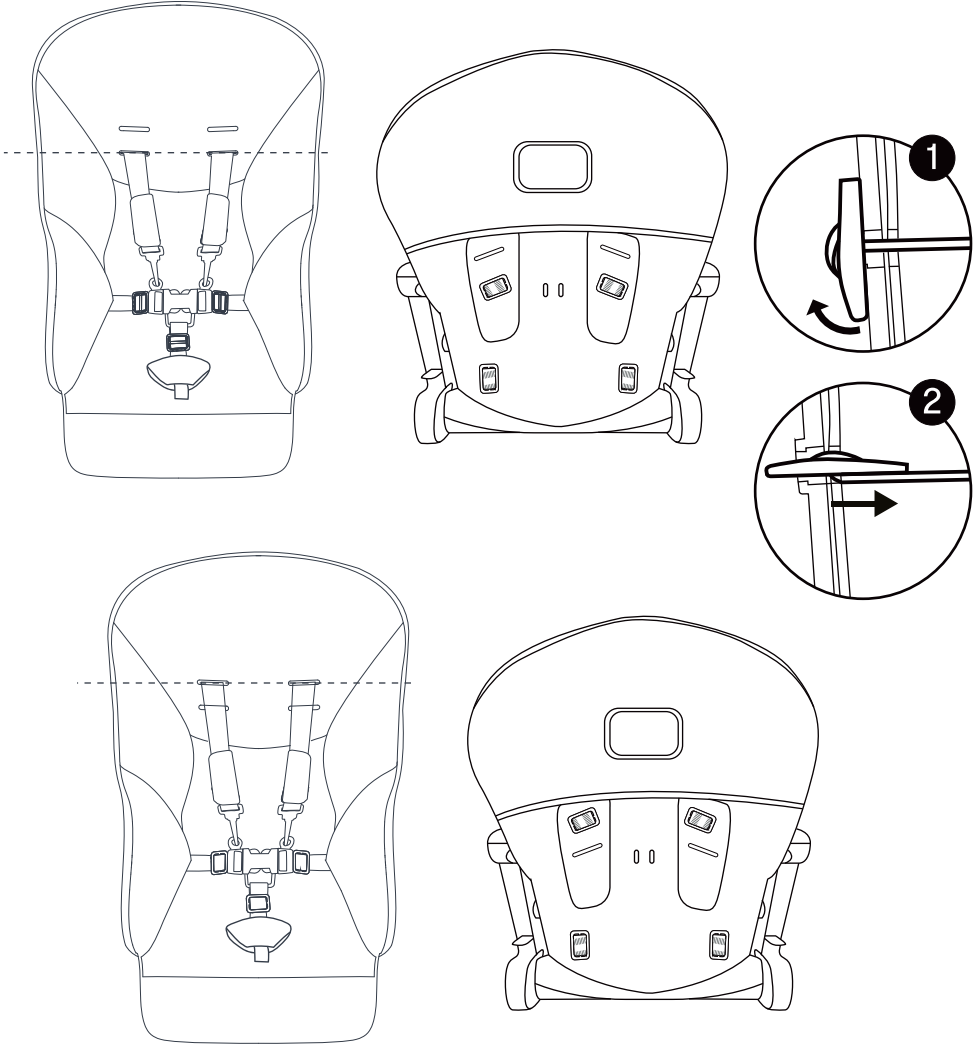

# Highchair Operation

## Folding

Simultaneously press and hold the folding buttons found on both sides of the frame and push the rear legs in with your feet.

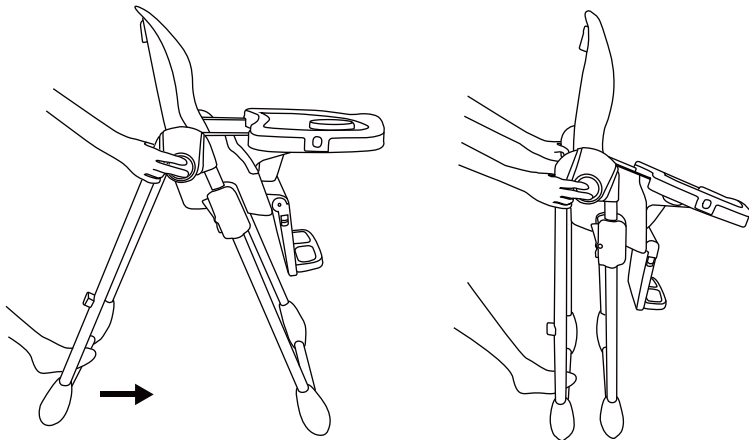

For a more compact fold, simultaneously press in both height adjustment buttons to lower the seat and hang the tray on the rear of the highchair.

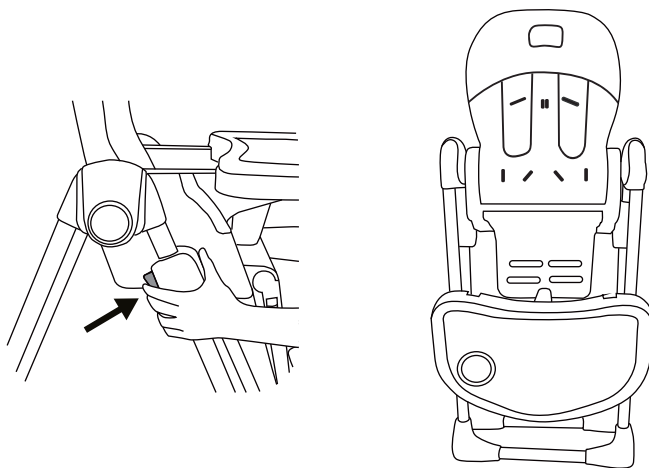

# Care

## Cleaning

- › Wipe metals and plastics clean with a damp cloth.
- › Clean by sponging with warm water and a mild detergent. A mild disinfectant may be used. Stubborn marks may be removed with a non-abrasive cream cleaner.
- › Do not bleach.
- › Do not iron.
- › Do not dry clean.
- › Do not use abrasive pads, bleach or strong household cleaners.
- › Dry thoroughly before re-use or storage.

## Maintenance

- › This product requires regular maintenance to keep it in good working order. Regularly check all parts of the product to ensure that they are operating correctly and for signs of wear or damage.
- › Before use, always check for any missing parts, torn material or if it is broken or damaged.
- › Replace parts as needed by contacting Kmart Customer Service.
- › NEVER USE if parts are missing or damaged.
- › Use only parts and accessories approved by the manufacturer.

KEYCODE: 43097845

Made in China

FOR AU / NZ: IMPORTED FOR KMART STORES IN AUSTRALIA AND NEW ZEALAND.

**KMART CUSTOMER SERVICE:**

**AU: 1800 124 125**

**NZ: 0800 945 995**