

# Assembly Instruction

## 43107612 THORNE BUFFET BLK

### CARE INSTRUCTIONS:





WIPE CLEAN WITH A SOFT DAMP CLOTH. DO NOT USE ABRASIVE MATERIALS AND SOLVENTS. CHECK AND TIGHTEN ALL PARTS REGULARLY. DO NOT PLACE HOT ITEMS SUCH AS COFFEE CUPS DIRECTLY ON THE SURFACE. KEEP AWAY FROM WATER AND DIRECT SUNLIGHT. STORE IN A DRY PLACE. FOR DOMESTIC USE ONLY. FOR INDOOR USE ONLY. A MILD ODOUR MAY BE PRESENT WHEN FIRST OPENING THIS CARTON. SIMPLY ALLOW TO AIR OUTSIDE AND THIS WILL FADE.





### WARNING:



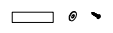

DO NOT STAND OR SIT ON THIS UNIT. DO NOT USE THIS UNIT UNLESS ALL BOLTS AND SCREWS ARE FIRMLY SECURED. DO NOT KNOCK OR DRAG THIS UNIT. USE ONLY ON A FLAT SURFACE. ADULT ASSEMBLY REQUIRED. FAILURE TO FOLLOW THESE WARNING COULD RESULT IN SERIOUS INJURY. LOAD DRAWER EVENLY TO PREVENT FROM TIPPING OVER. THIS PACKAGE CONTAINS SMALL PARTS AND SHARP POINTS. KEEP AWAY FROM CHILDREN AND BABIES.



**MAXIMUM SAFE LOAD: 20KG FOR TOP PANEL, 5KG FOR EACH DRAWER, 10KG FOR EACH LAYER.**

## Hardware List

	a	6x35mm	20pcs
	b	15x9.5mm	20pcs
	c	6x30mm	42pcs
	d	4x35mm	26pcs

	e	4x12mm	2pcs
	f	4x35mm	2pcs
	g		2pcs
	h		2pcs

	i	4x14mm	24pcs
	j		8pcs
	k	2x16mm	16pcs
	l	4x55mm	12pcs

	m	4x25mm	16pcs
	n	6x55mm	8pcs
	o	6x50mm	4pcs

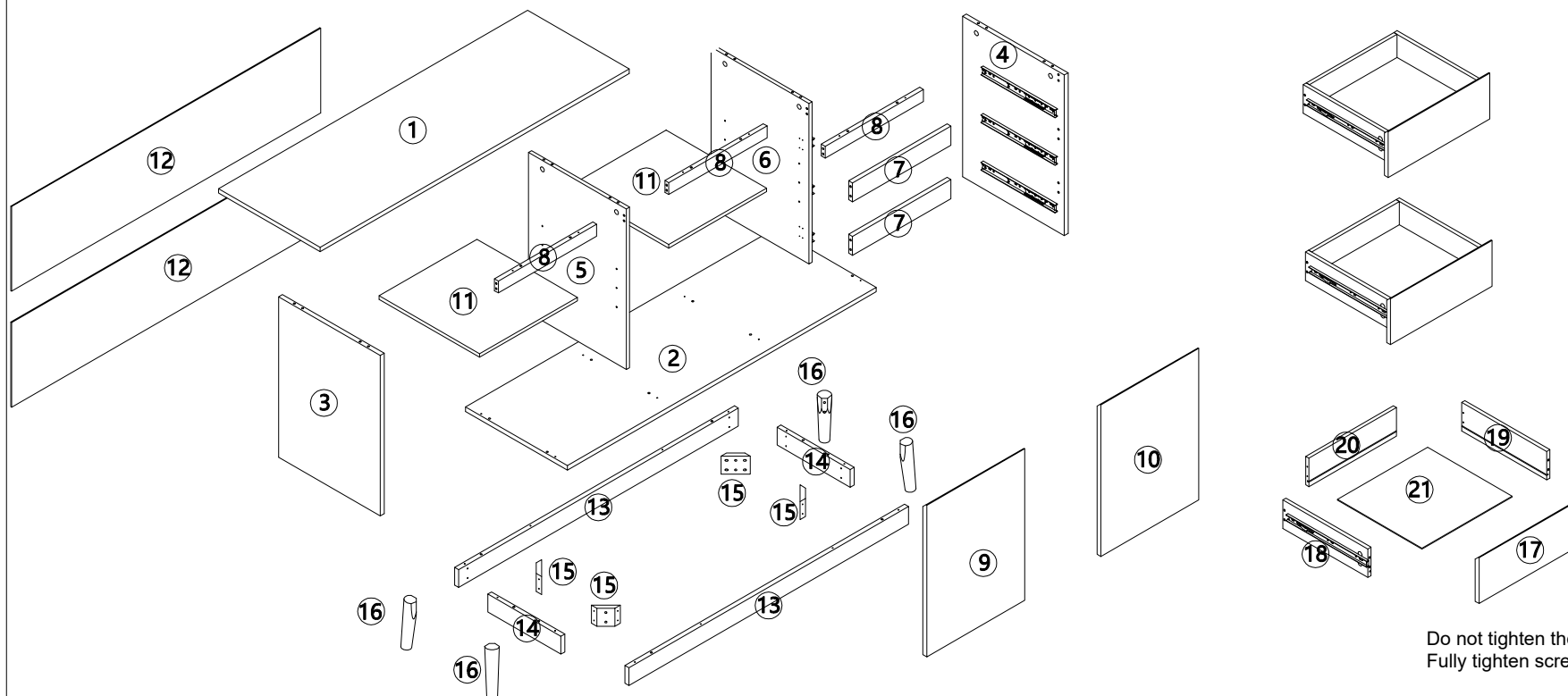

Do not tighten the screws fully during assembly.  
Fully tighten screws after the final assembly steps.

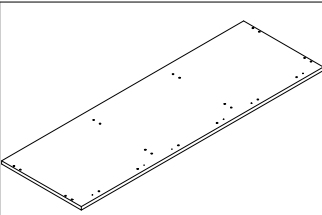
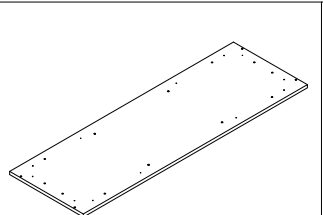
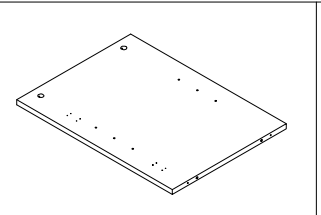
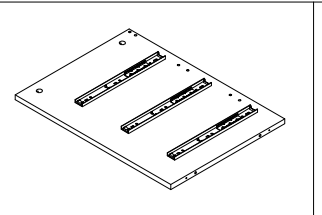
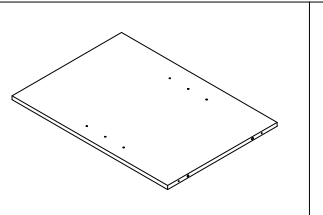
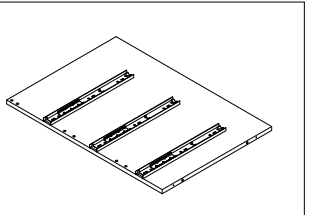
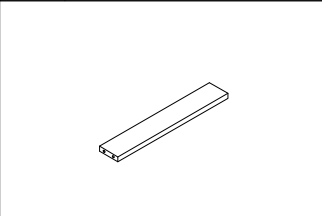
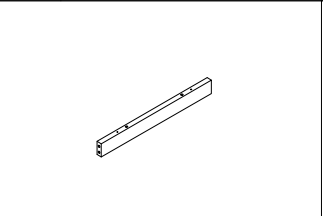
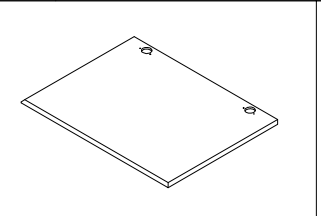
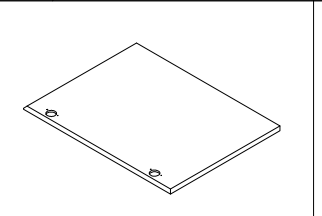
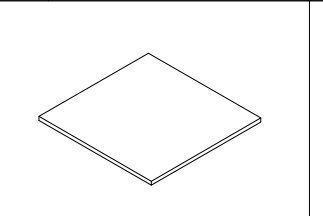
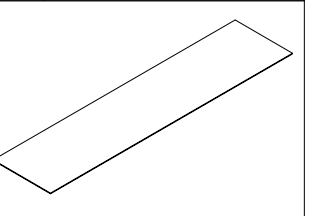
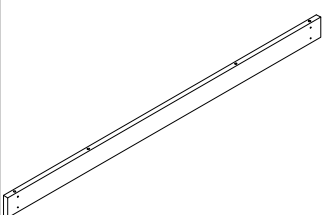
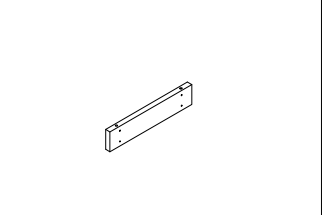
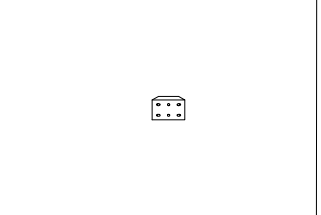
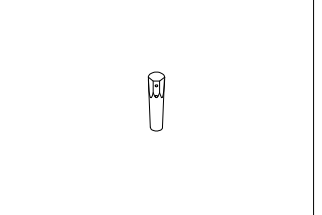
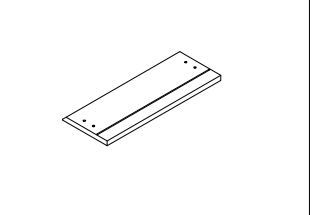
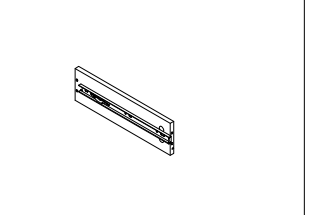
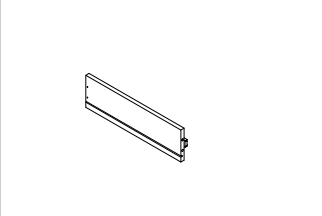
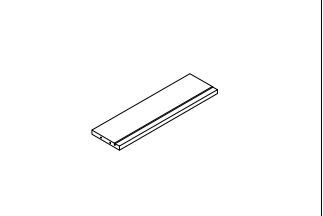
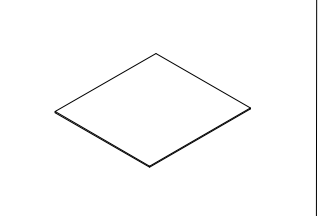

					
① 1PC	② 1PC	③ 1PC	④ 1PC	⑤ 1PC	⑥ 1PC
					
⑦ 2PCS	⑧ 3PCS	⑨ 1PC	⑩ 1PC	⑪ 2PCS	⑫ 2PCS
					
⑬ 2PCS	⑭ 2PCS	⑮ 4PCS	⑯ 4PCS	⑰ 3PCS	⑱ 3PCS
					
⑲ 3PCS	⑳ 3PCS	㉑ 3PCS			

### Step 1:

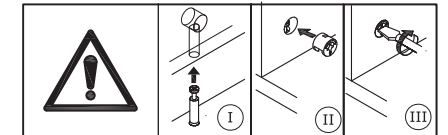
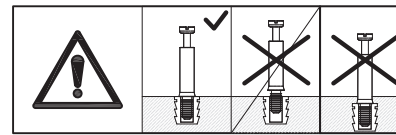
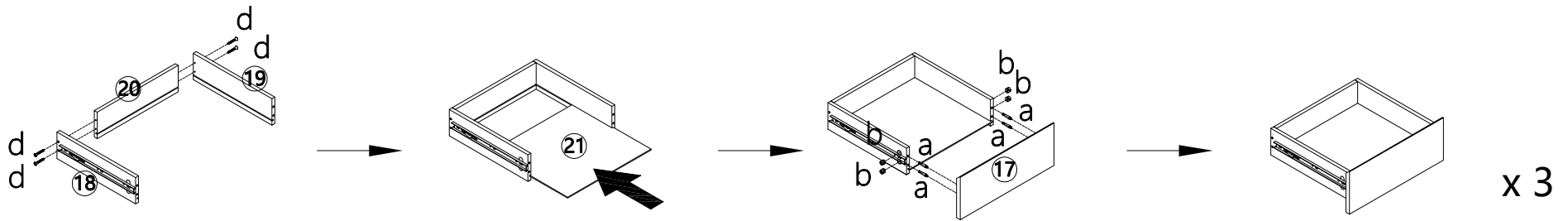
 x 12    x 12    x 12





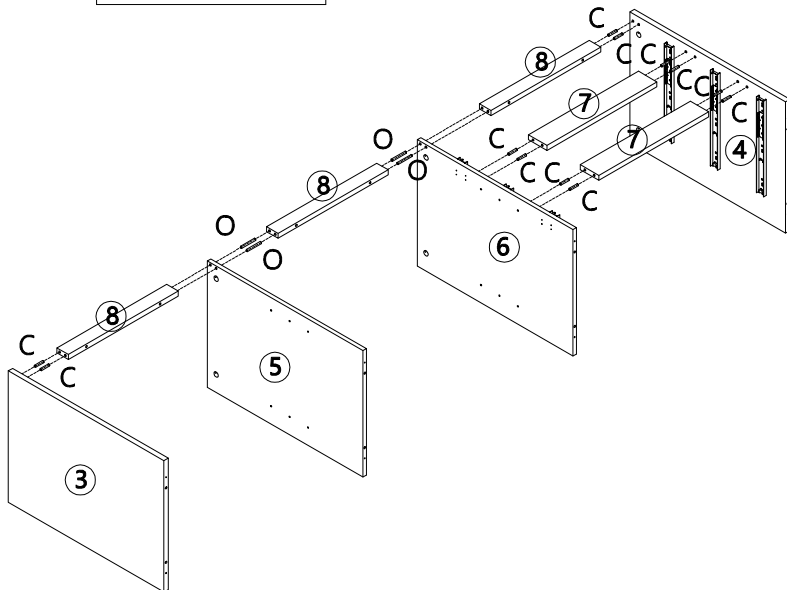

### Step 2:

 x 12    x 4



### Step 3:

 x 8    x 8    x 14    x 6

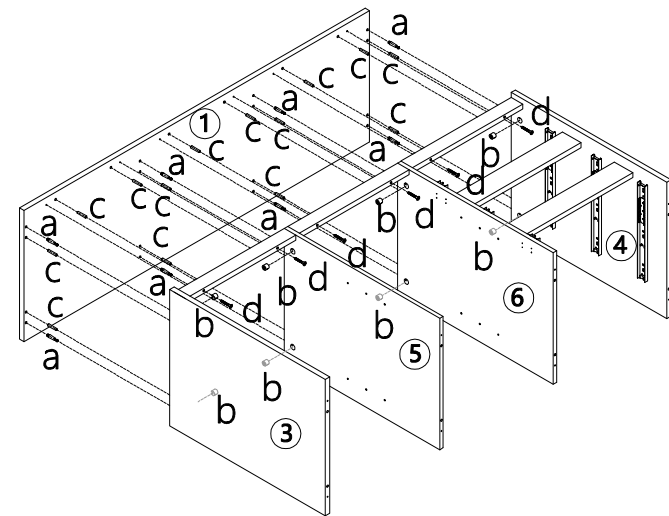



Step 8:

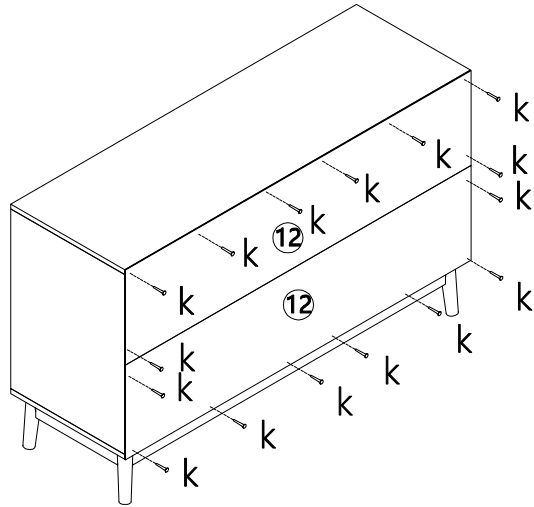
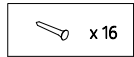

Step 9:

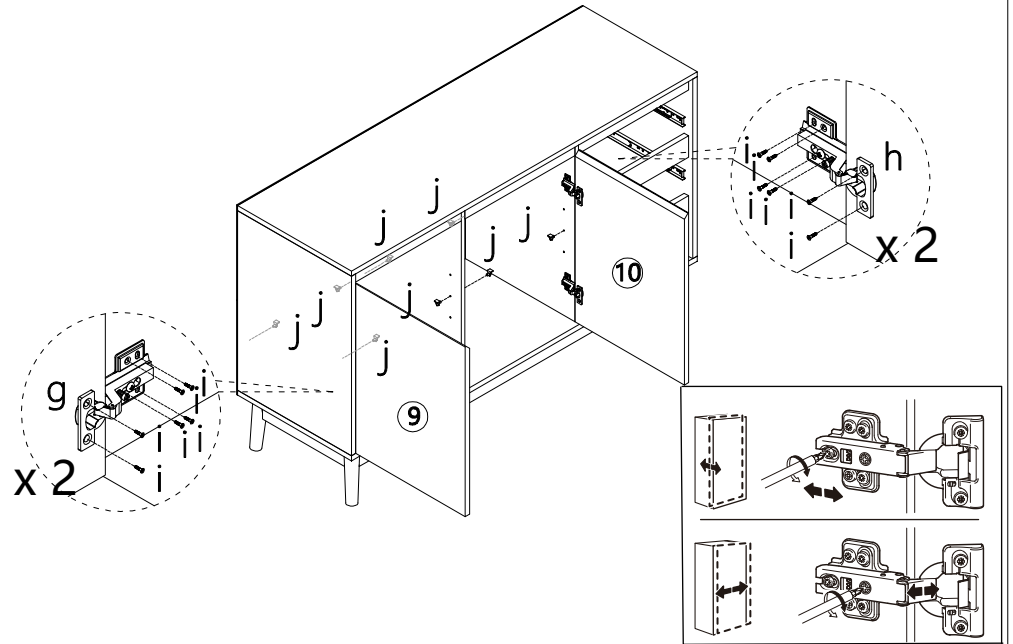
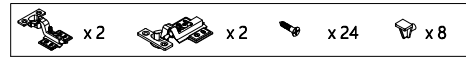

Step 10:

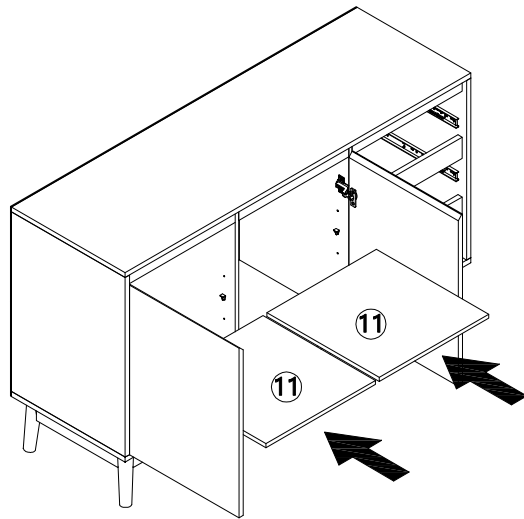

Step 11:

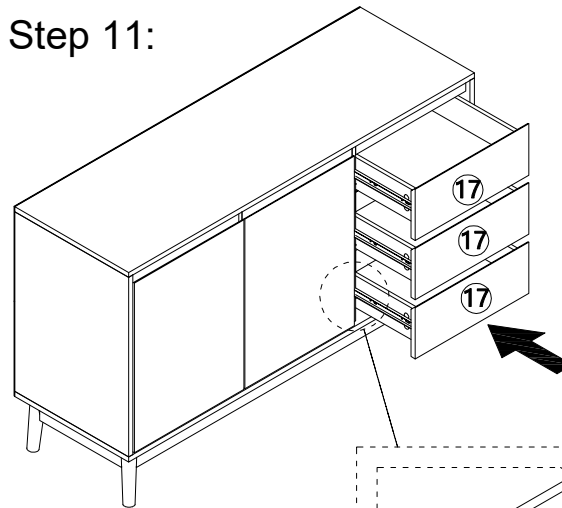

Slide ball bearing side part to top of rail when assembling the drawer.

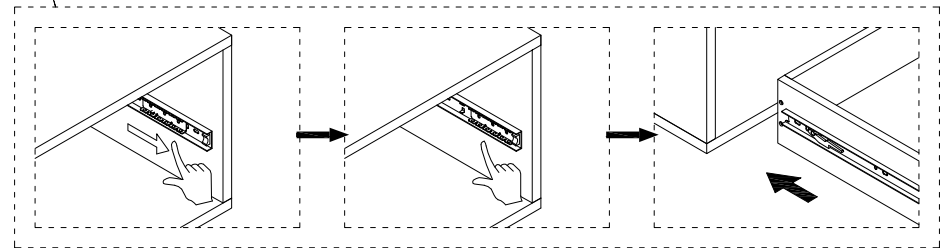

## Step 12:

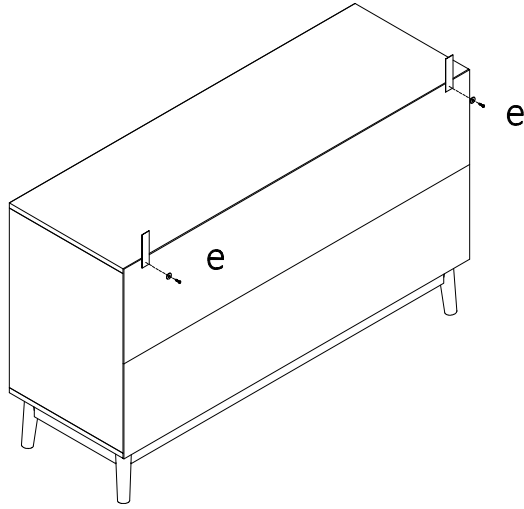

User instructions should include the wording:

- **It is strongly recommended that this product is permanently fixed to the wall.**
- **Please seek professional advice if you are in doubt of what fixing device to use.**
- **Regularly check that anchors are securely maintained.**
- **Stability of tall items may be affected by thick pile carpet or uneven floors .**
- **Do not place unanchored televisions on furniture .**

**CAUTION:** for your safety when attaching the anchor fixings, please note the following:

- **Check any electrical wires or plumbing inside the wall before drilling any holes (if you are unsure please seek professional advice from a qualified tradesperson).**



**WARNING:** PLEASE SECURE YOUR FURNITURE WITH THE SUPPLIED WALL FIXING. SCAN THE CODE FOR MORE INFORMATION.

