

Assembly Instruction

43114627 THORNE BOOKSHELF

CARE INSTRUCTIONS:







WIPE CLEAN WITH A SOFT DAMP CLOTH. DO NOT USE ABRASIVE MATERIALS AND SOLVENTS. CHECK AND TIGHTEN ALL PARTS REGULARLY. DO NOT PLACE HOT ITEMS SUCH AS COFFEE CUPS DIRECTLY ON THE SHELF. KEEP AWAY FROM WATER AND DIRECT SUNLIGHT. STORE IN A DRY PLACE. FOR DOMESTIC USE ONLY. FOR INDOOR USE ONLY. A MILD ODOUR MAY BE PRESENT WHEN FIRST OPENING THIS CARTON. SIMPLY ALLOW TO AIR OUTSIDE AND THIS WILL FADE.





WARNING:





DO NOT STAND OR SIT ON THIS UNIT. DO NOT USE THIS UNIT UNLESS ALL BOLTS AND SCREWS ARE FIRMLY SECURED. DO NOT KNOCK OR DRAG THIS UNIT. USE ONLY ON A FLAT SURFACE. ADULT ASSEMBLY REQUIRED. FAILURE TO FOLLOW THESE WARNING COULD RESULT IN SERIOUS INJURY. THIS PACKAGE CONTAINS SMALL PARTS AND SHARP POINTS. KEEP AWAY FROM CHILDREN AND BABIES.

MAXIMUM SAFE LOAD: 5KG FOR SHORT SHELF, 10KG FOR LONG SHELF.

Hardware List

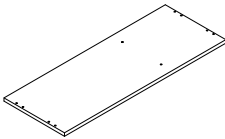
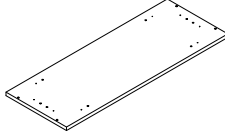
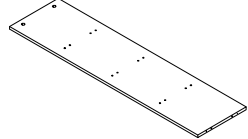
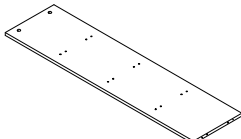
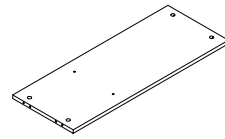
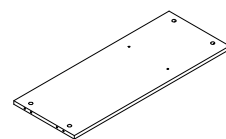
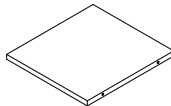
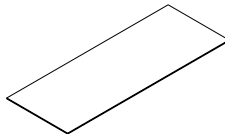
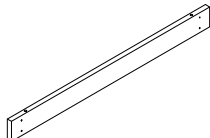
| | | | |
|---|---|----------|-------|
|  | a | 6x35mm | 16pcs |
|  | b | 15x9.5mm | 16pcs |
|  | c | 6x30mm | 44pcs |
|  | d | 4x35mm | 4pcs |
|  | e | | 20pcs |
|  | f | 4x55mm | 8pcs |

| | | | |
|---|---|--------|-------|
|  | g | 4x25mm | 16pcs |
|  | h | 6x55mm | 8pcs |
|  | i | 4x12mm | 2pcs |
|  | j | 4x35mm | 2pcs |
|  | k | | 6pcs |

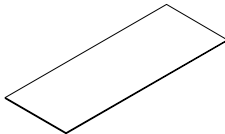
| | | | | | | | | |
|---|---|------|---|---|------|---|---|------|
|  | ① | 1PC |  | ② | 1PC |  | ③ | 1PC |
|  | ④ | 1PC |  | ⑤ | 2PCS |  | ⑥ | 1PC |
|  | ⑦ | 4PCS |  | ⑧ | 2PCS |  | ⑨ | 2PCS |
|  | ⑩ | 2PCS |  | ⑪ | 4PCS |  | ⑫ | 4PCS |
|  | ⑬ | 2PCS | | | | | | |

Do not tighten the screws fully during assembly.
Fully tighten screws after the final assembly steps.

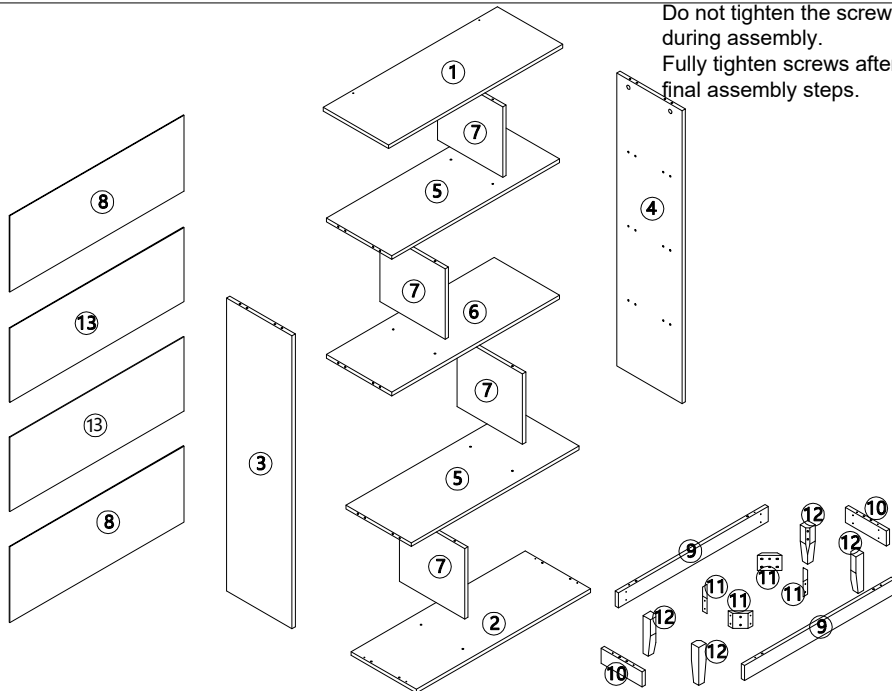

Step 1:

 x12

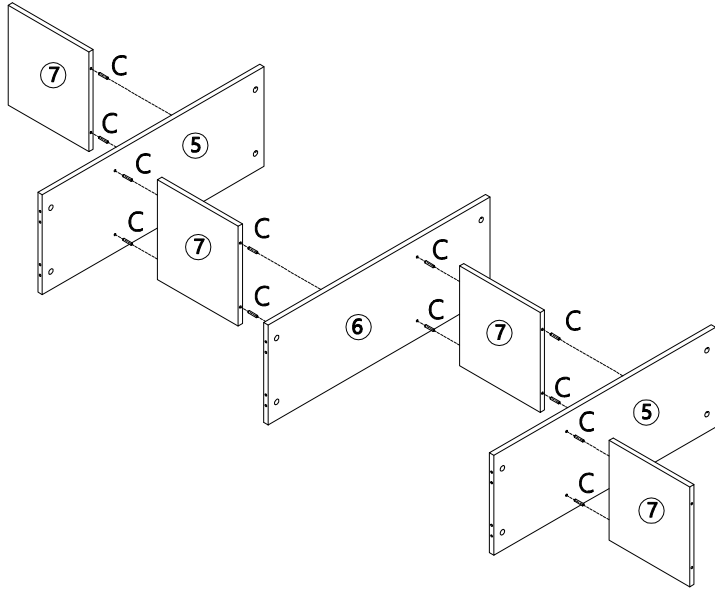



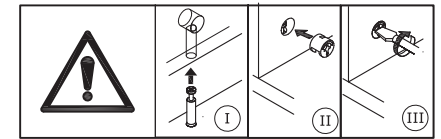
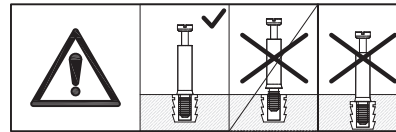
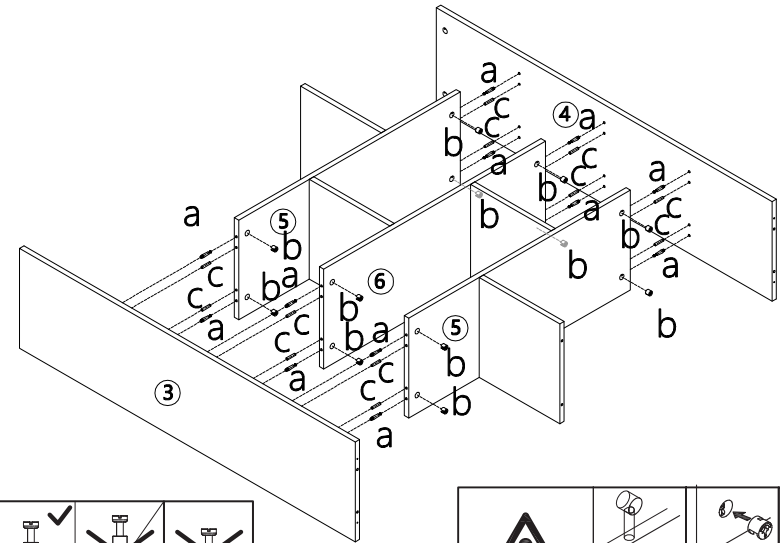

Step 2:

 x12  x12  x12



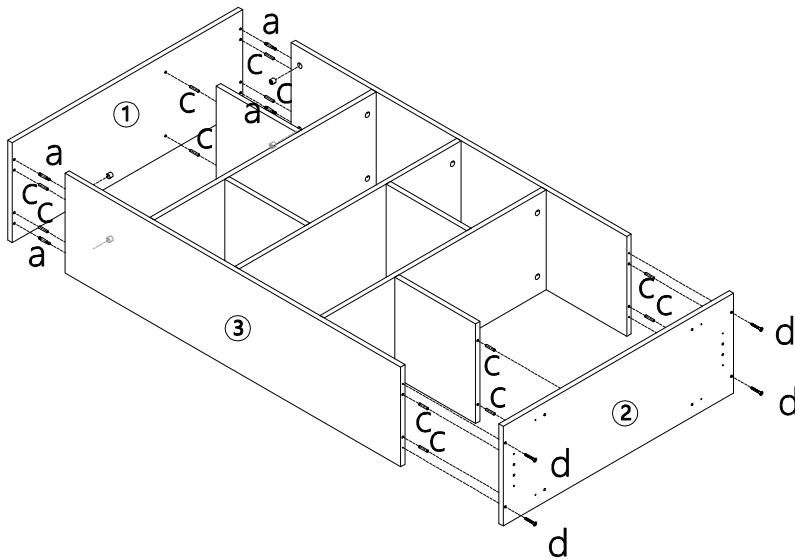

Step 3:

 x4  x4  x12  x4



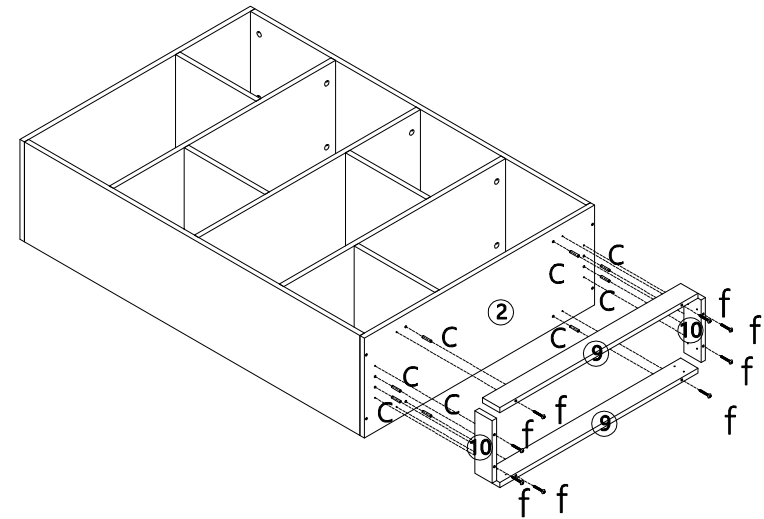

Step 4:

 x8  x8

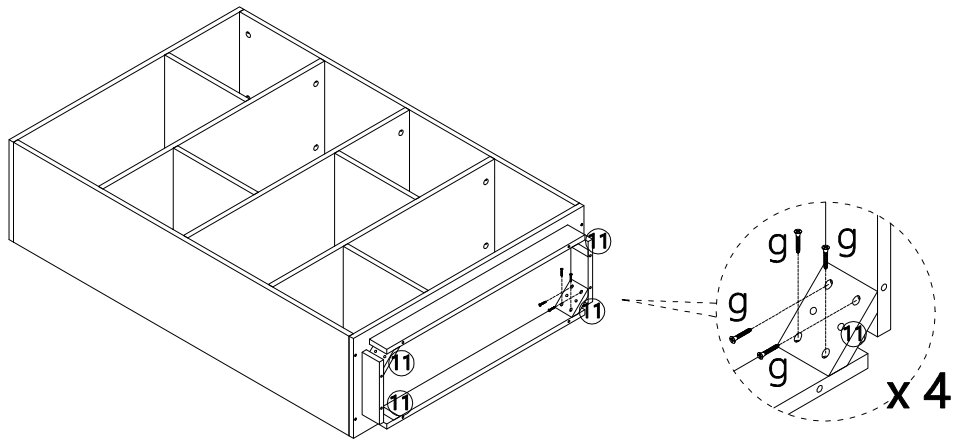

Step 5:  x16



Step 6:  x8

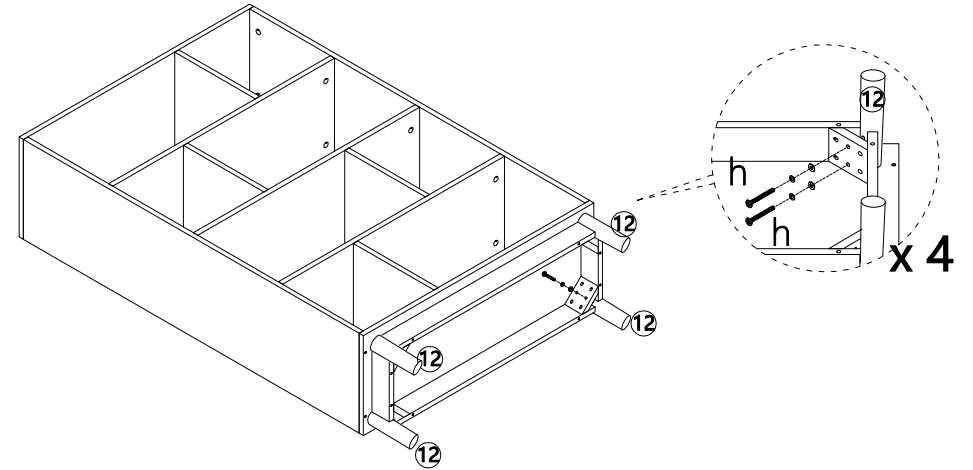

Step 7:  x16  x 6

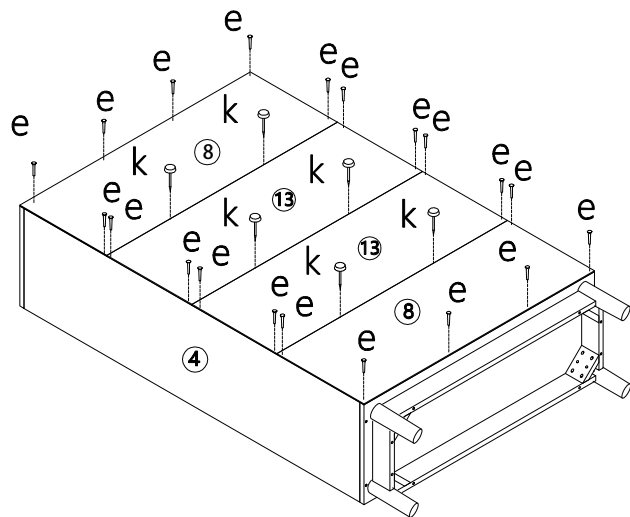

Step 8:  x2

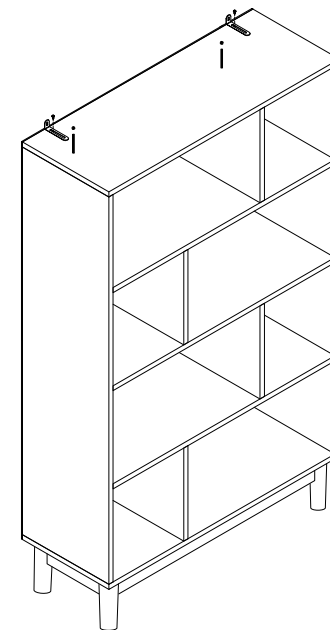

Step 9:

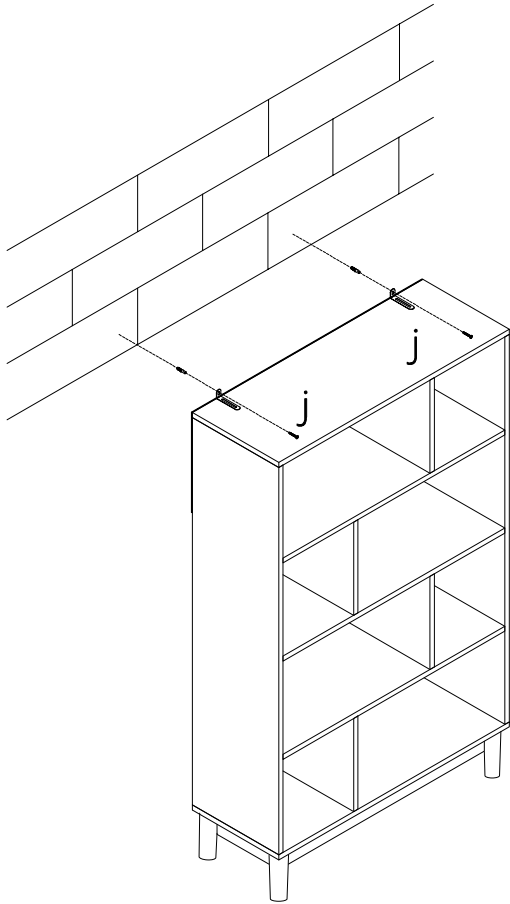

User instructions should include the wording:

- **It is strongly recommended that this product is permanently fixed to the wall.**
- **Please seek professional advice if you are in doubt of what fixing device to use.**
- **Regularly check that anchors are securely maintained.**
- **Stability of tall items may be affected by thick pile carpet or uneven floors .**
- **Do not place unanchored televisions on furniture .**

CAUTION: for your safety when attaching the anchor fixings, please note the following:

- **Check any electrical wires or plumbing inside the wall before drilling any holes (if you are unsure please seek professional advice from a qualified tradesperson).**



WARNING: PLEASE SECURE YOUR FURNITURE WITH THE SUPPLIED WALL FIXING. SCAN THE CODE FOR MORE INFORMATION.

