

Assembly Instructions

43228676 ELTON STORAGE CABINET

CARE INSTRUCTIONS:











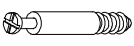



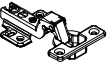

WIPE CLEAN WITH A DRY CLOTH. DO NOT USE ABRASIVE MATERIALS AND SOLVENTS. CHECK AND TIGHTEN ALL PARTS REGULARLY. DO NOT PLACE HOT ITEMS SUCH AS COFFEE CUPS DIRECTLY ON THE SURFACE. KEEP AWAY FROM WATER AND DIRECT SUNLIGHT. STORE IN A DRY PLACE. FOR DOMESTIC USE ONLY. FOR INDOOR USE ONLY. A MILD ODOUR MAY BE PRESENT WHEN FIRST OPENING THIS CARTON. SIMPLY ALLOW TO AIR OUTSIDE AND THIS WILL FADE.

WARNING:



DO NOT STAND OR SIT ON THIS UNIT. DO NOT USE THIS UNIT UNLESS ALL BOLTS AND SCREWS ARE FIRMLY SECURED. DO NOT KNOCK OR DRAG THIS UNIT. USE ONLY ON A FLAT SURFACE. ADULT ASSEMBLY REQUIRED. FAILURE TO FOLLOW THESE WARNINGS COULD RESULT IN SERIOUS INJURY. LOAD DRAWER EVENLY TO PREVENT FROM TIPPING OVER. THIS PACKAGE CONTAINS SMALL PARTS AND SHARP POINTS. KEEP AWAY FROM CHILDREN AND BABIES.

MAXIMUM SAFE LOAD: TOP: 25KG, EACH SHELF: 5KG.

1 Hardware List

	A	M6x35mm	12pcs		B	∅ 15x12mm	8pcs		C	∅ 15x10mm	4pcs
	D	∅ 8x30mm	26pcs		E	M5x40mm	20pcs		F	M3.5x12mm	42pcs
	G		4pcs		H		2pcs		I		3pcs
	J		3pcs		K		12pcs		L		12pcs
	M		2pcs		N	M4x35mm	2pcs		O	M4x12mm	2pcs
	P	∅ 6x30mm	2pcs		Q	M3.5x15mm	12pcs				

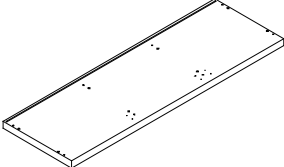
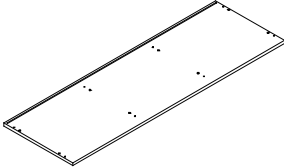
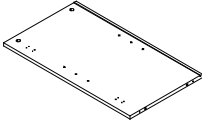
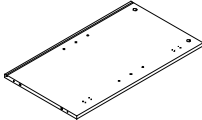
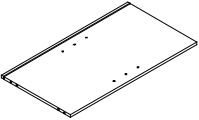
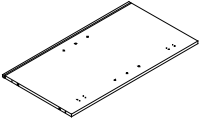
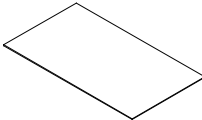
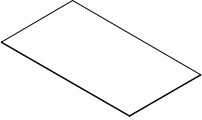
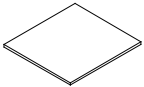
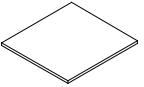
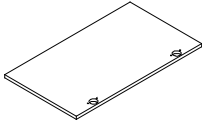
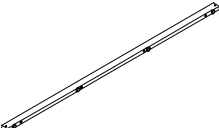
2 Parts List



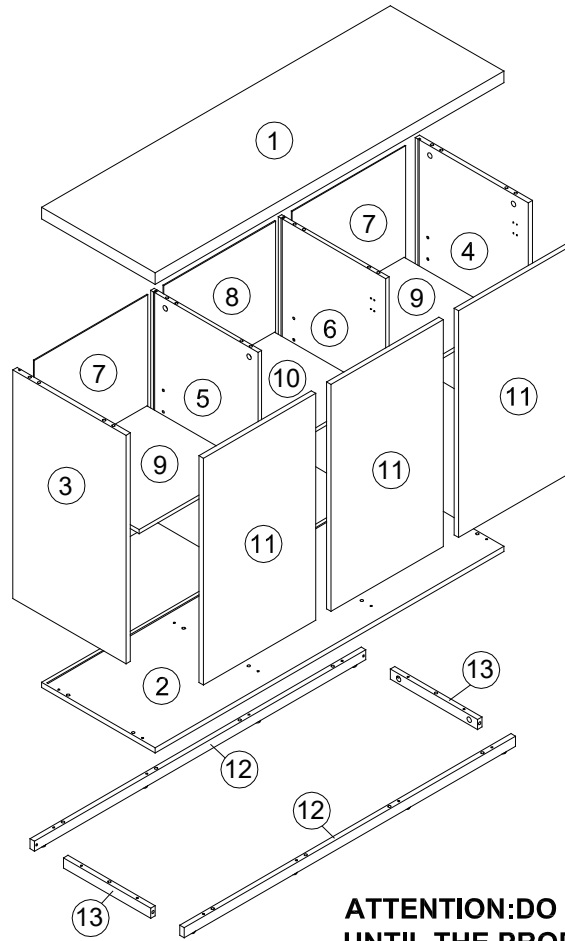

	①	1pc		②	1pc		③	1pc		④	1pc
	⑤	1pc		⑥	1pc		⑦	2pcs		⑧	1pc
	⑨	2pcs		⑩	1pc		⑪	3pcs		⑫	2pcs
	⑬	2pcs									

3



Tool required
Phillips Head Screw Driver
(Not Provided)

**ATTENTION: DO NOT TIGHTEN THE SCREWS
UNTIL THE PRODUCT IS FULLY ASSEMBLED.**

STEP 1 A -  x 8 F -  x 6 I -  x 3 J -  x 3

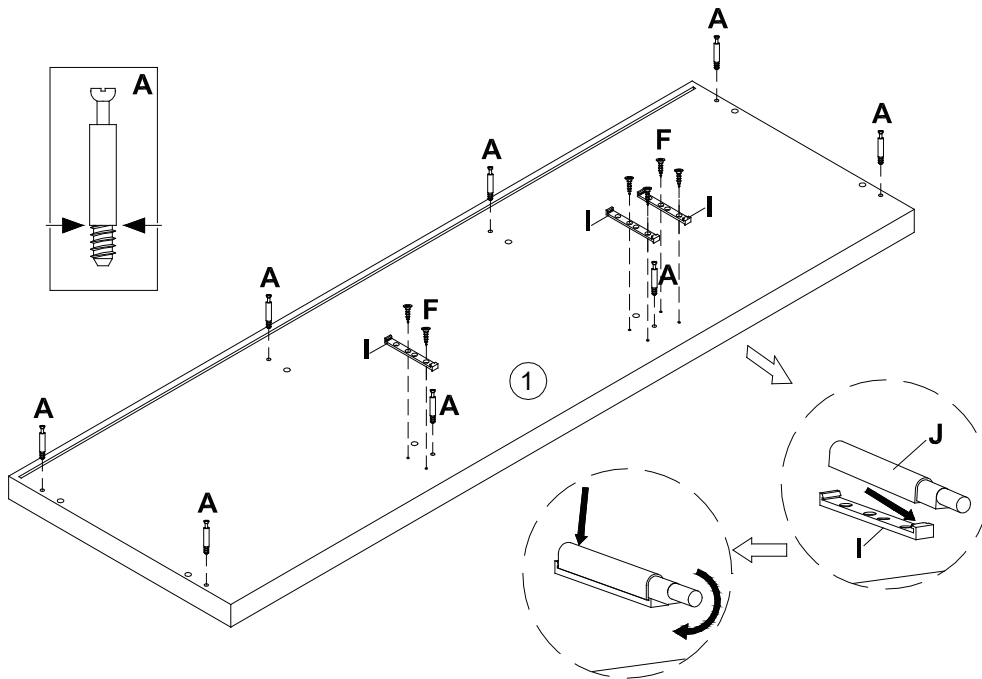

STEP 2 B -  x 4 C -  x 4 D -  x 8

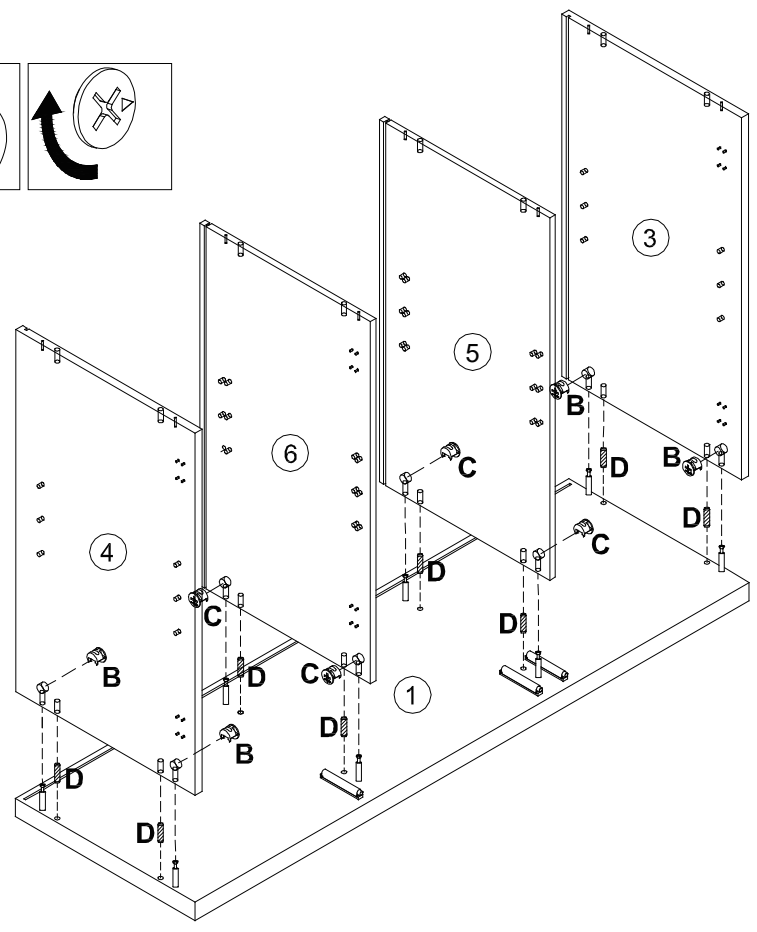
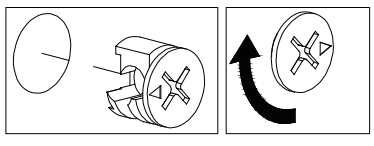

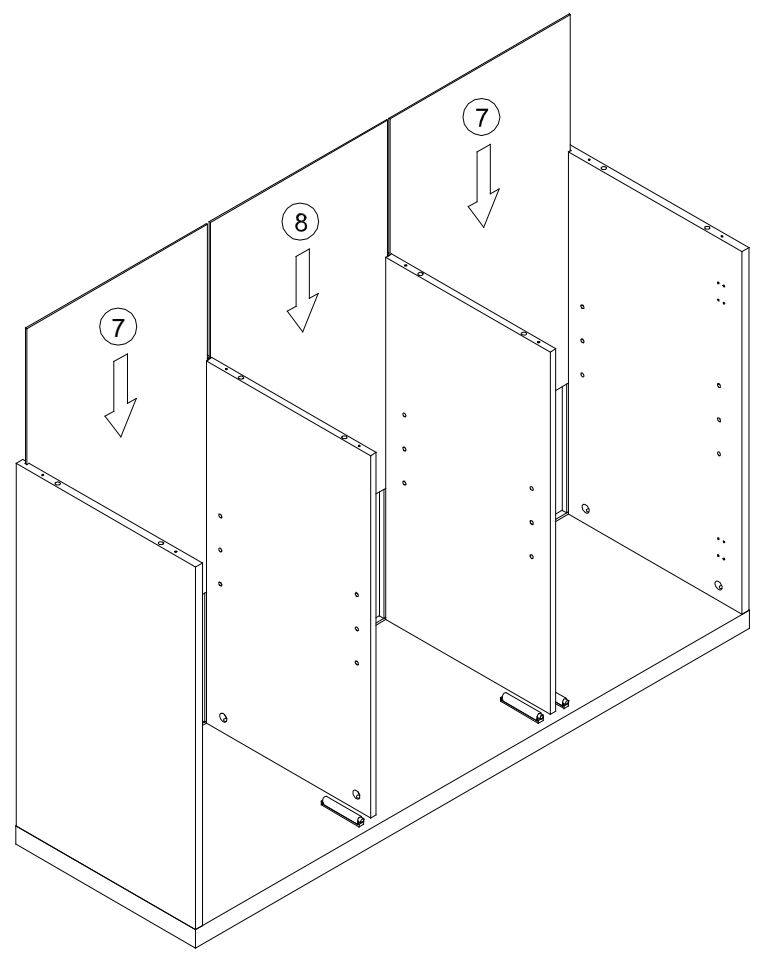

STEP 3



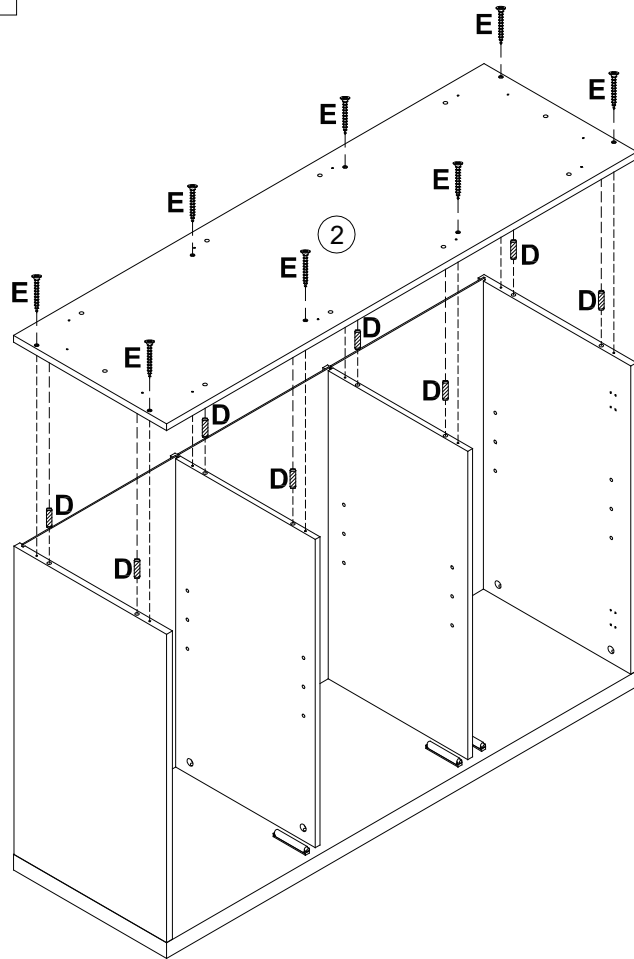

STEP 4 D -  x 8 E -  x 8

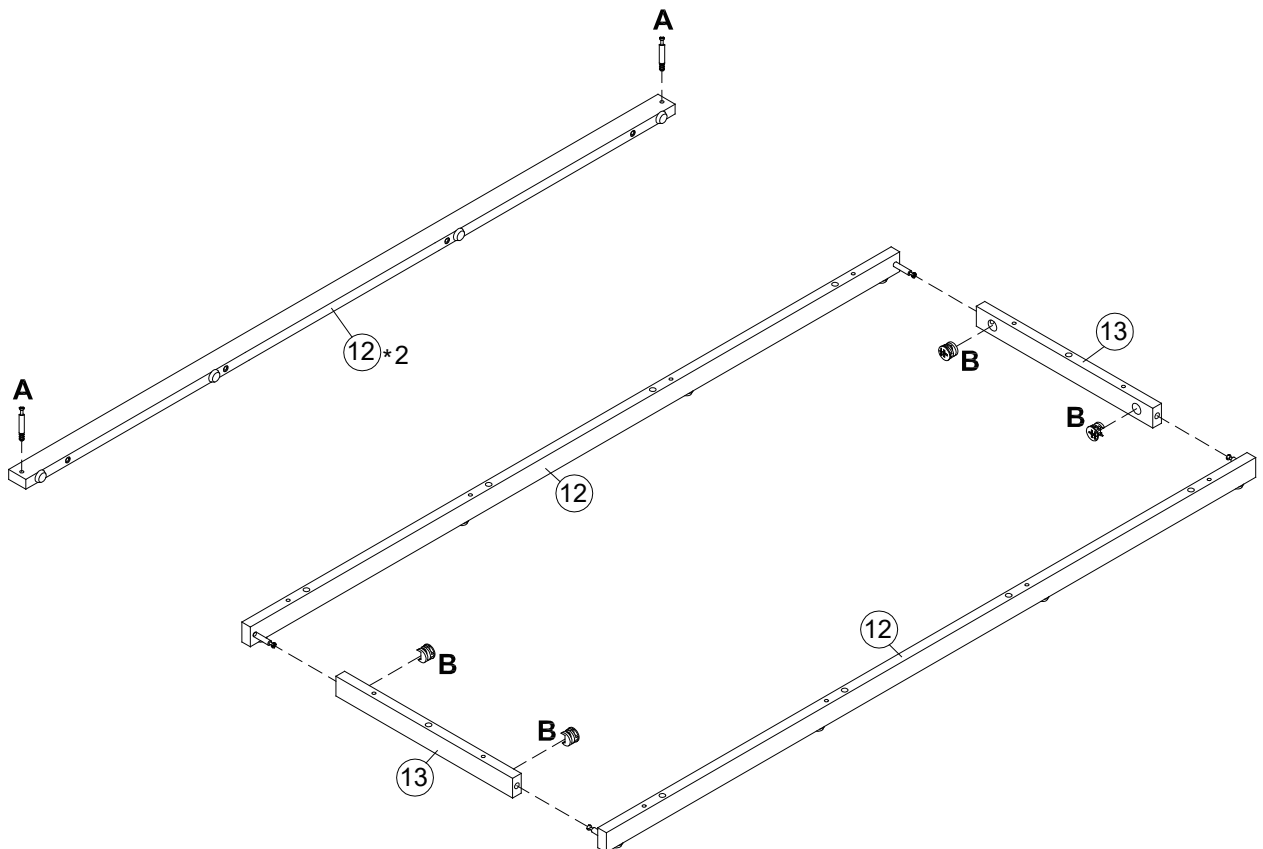

STEP 5 A -  x 4 B -  x 4



STEP 6 D -  x 10 E -  x 12

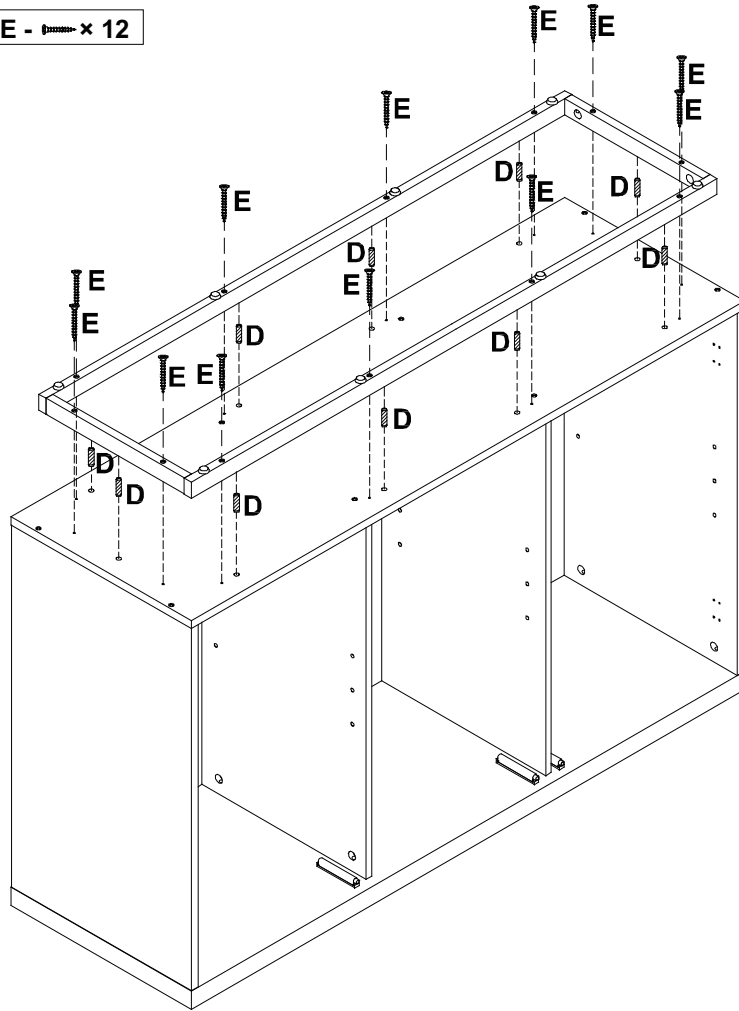

STEP 7 K -  x 12

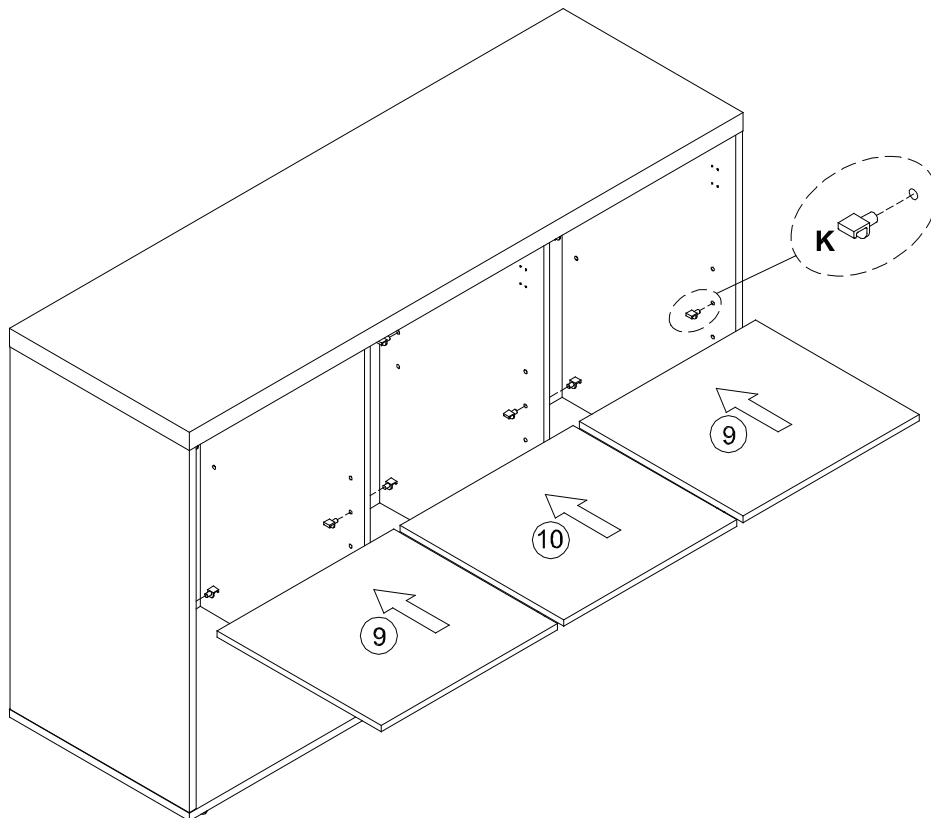



STEP 8

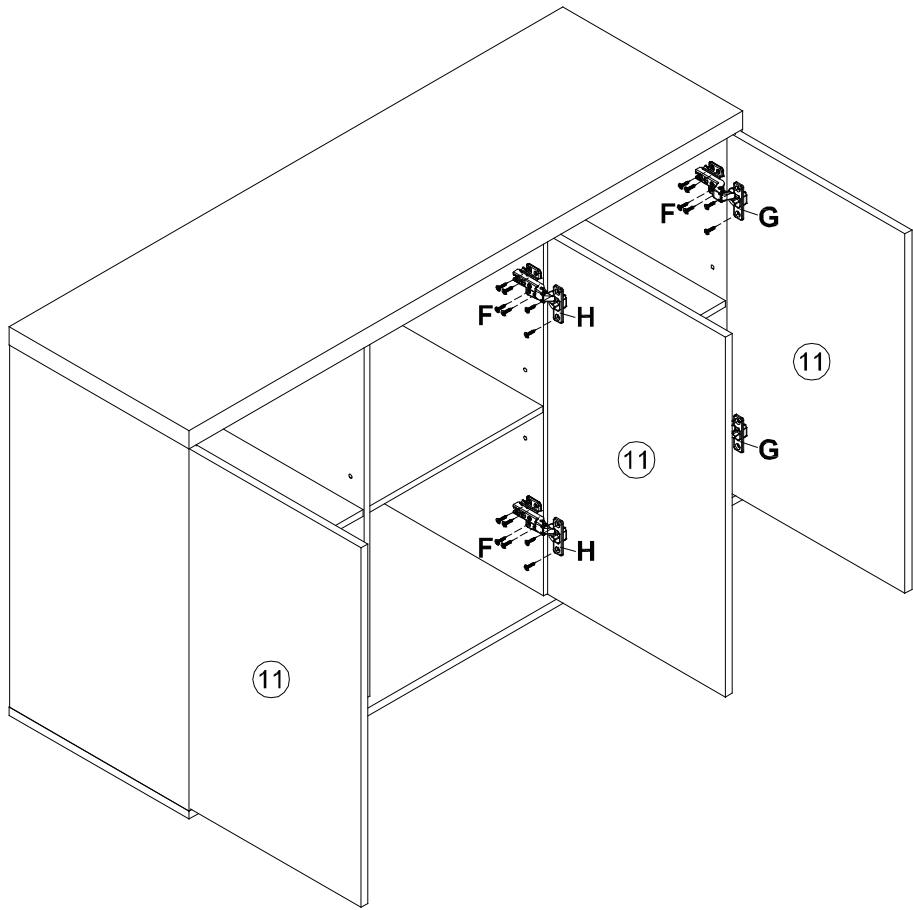

F -  x 36 G -  x 4 H -  x 2

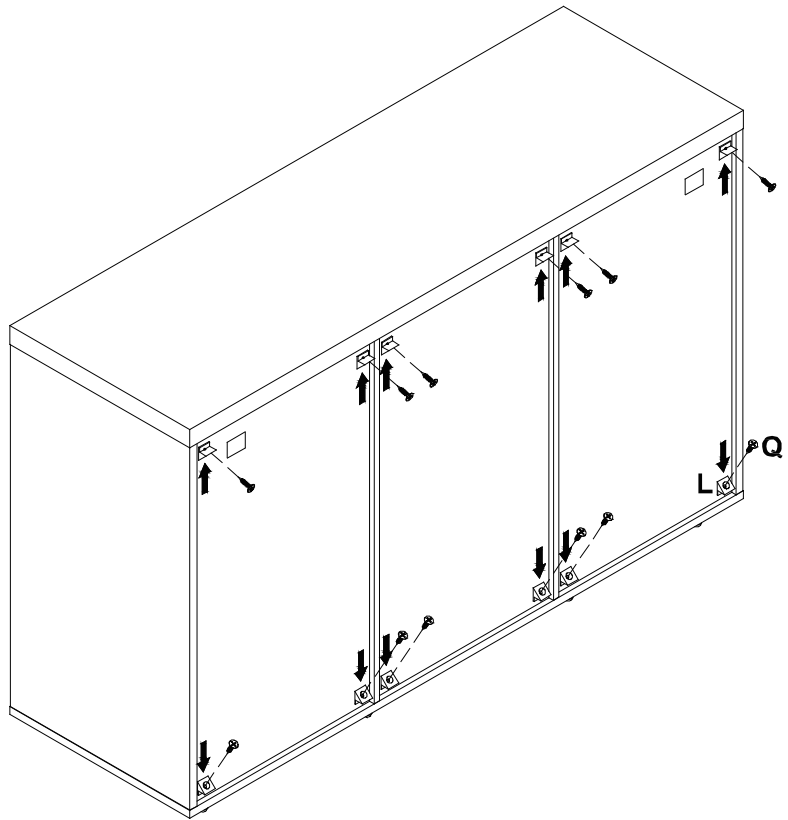

STEP 9

Q -  x 12 L -  x 12

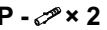

STEP 10 M -  x 2 N -  x 2 O -  x 2 P -  x 2

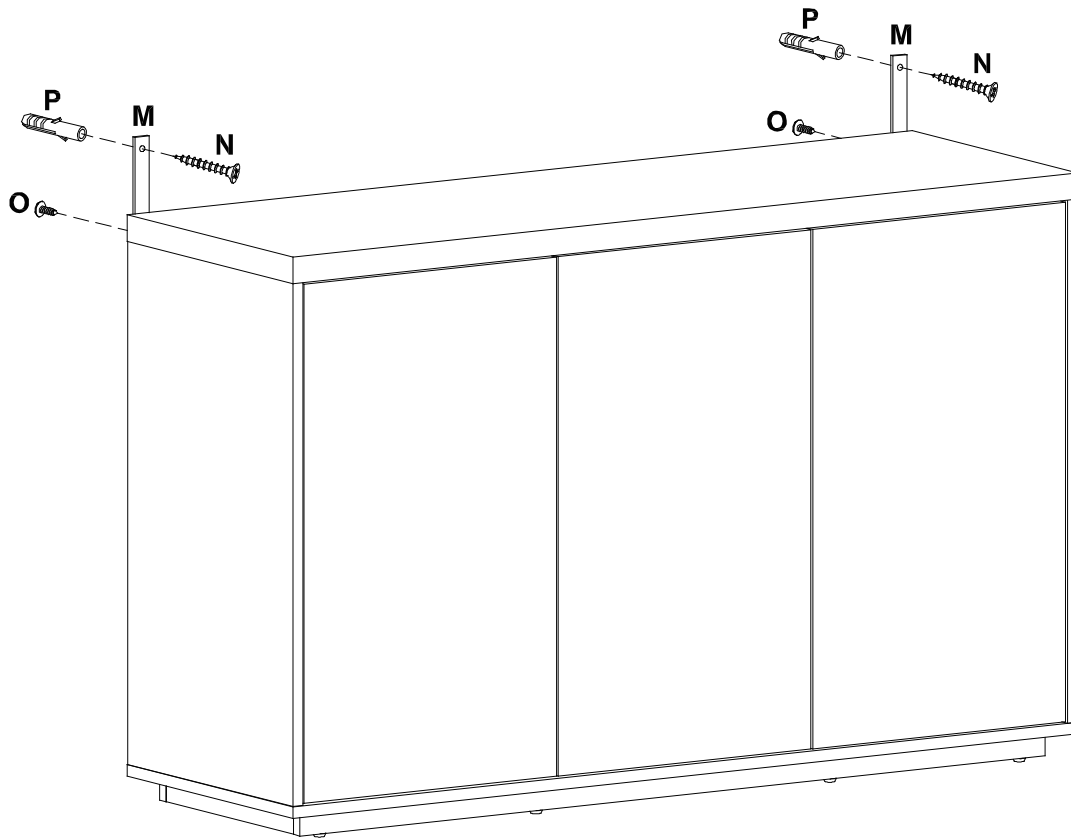

TOPPLING FURNITURE WARNING:

- It is strongly recommended that this product is permanently fixed to the wall.
- Please seek professional advice if you are in doubt of what fixing device to use.
- Regularly check that anchors are securely maintained.
- Stability of tall items may be affected by thick pile carpet or uneven floors .
- Do not place unanchored televisions on furniture .

CAUTION: for your safety when attaching the anchor fixings, please note the following:

- Check any electrical wires or plumbing inside the wall before drilling any holes (if you are unsure please seek professional advice from a qualified tradesperson).



WARNING: PLEASE SECURE YOUR FURNITURE WITH THE SUPPLIED WALL FIXING. SCAN THE CODE FOR MORE INFORMATION.



Hinger Adjustment Tips

Noted: The door might be scraping, bumping, misaligned when first assembly.

Please follow the below tips:

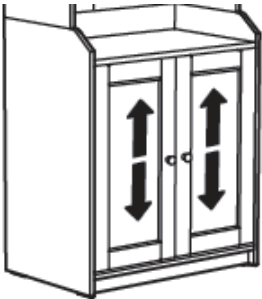

Adjust the door up and down

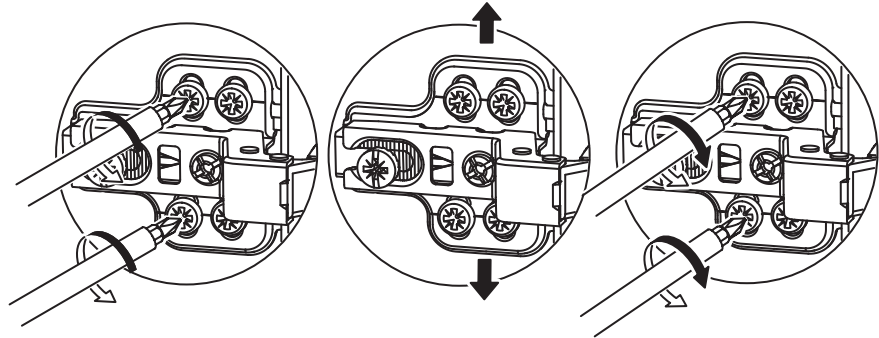

1. Loosen the two mounting screws on both hinges, but only slightly. ...
2. Gently close the cabinet door.
3. With the door still closed, adjust the cabinet door to the desired height.
4. Open the cabinet door again, being careful not to jostle the door out of position.
5. Retighten the screws by hand.

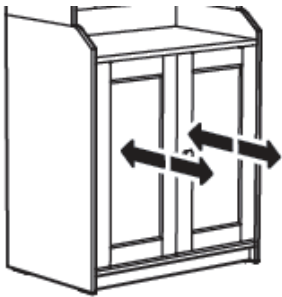

Move the door in and out

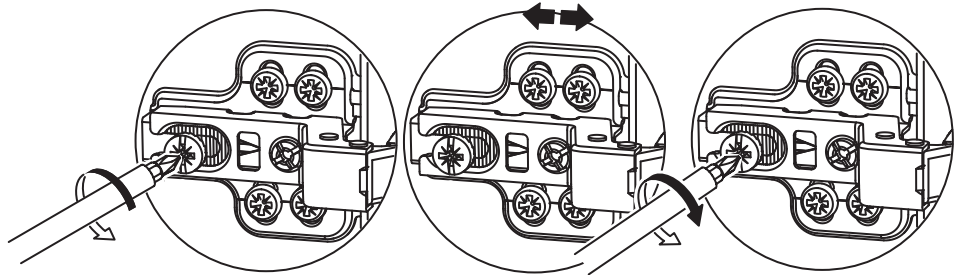

If the door doesn't meet the box at the top, adjust the top hinge toward the cabinet and/or adjust the bottom hinge away from the cabinet. If the door is gapped at the bottom, do the reverse.

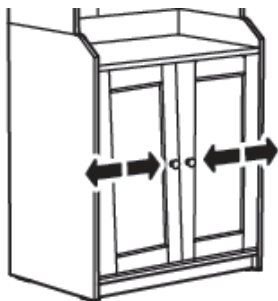

Move the door right or left

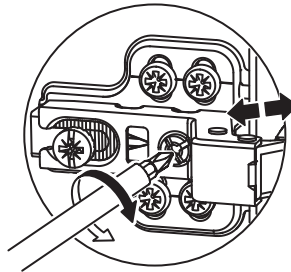

You can adjust one or both hinges on each door, depending on how much correction it needs. If the door seems to be tilting down to the right, turn the side-to-side screw on the top hinge so the hinge pulls closer to the side of the cabinet box, moving the top of the door to the left.