

Assembly Instructions

43230617 PANELLED 5 TIER SHELF UNIT

















CARE INSTRUCTIONS:

Wipe clean with a damp cloth. keep away from water and direct sunlight. for indoor and domestic use. check and tighten all parts regularly.

WARNING:

Do not stand, sit, or lean on the product. do not drag the product. use only on a flat surface. do not use until all screws, bdts and knobs are firmly secured. this product contains small parts and sharp points, keep away from children and babies. adult assembly required. failure to follow these warnings could result in serious injury.



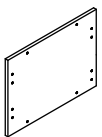
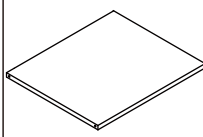
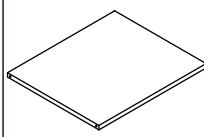
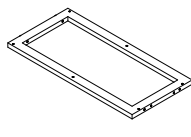
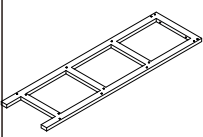
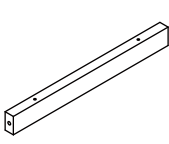
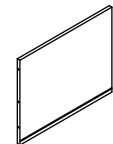
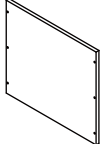
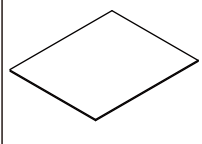
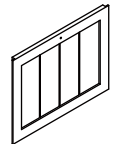
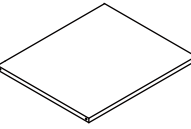
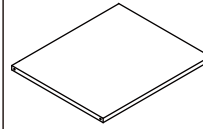
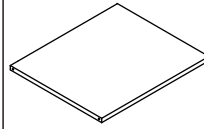
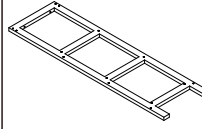

MAXIMUM SAFE LOAD: 5KG FOR EACH SHELF.

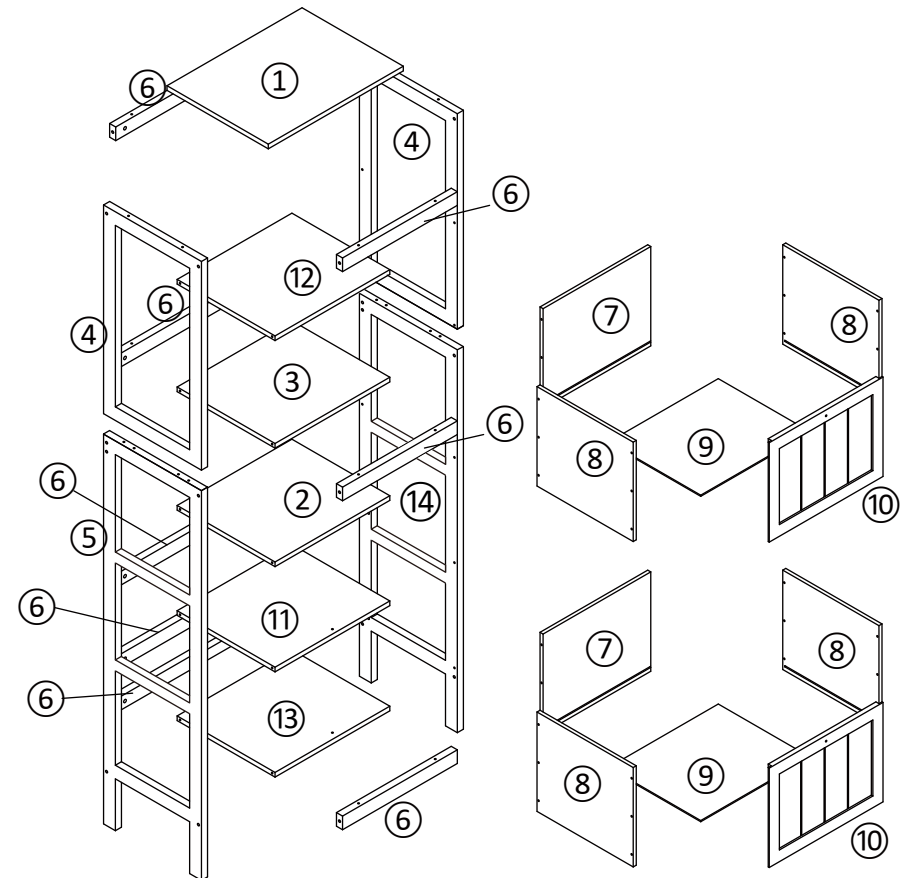
	a	m6x30	16pcs		g		2pcs
	b	m6x35	20pcs		h	m4x35	20pcs
	c	m15x10	20pcs		i	m3x25	24pcs
	d	m4x45	16pcs		j	m3x12	2pcs
	e	m4x45	4pcs		k		16pcs
	f	m4x16	2pcs		m		2 pcs
	s		1pc		r		1pc
	t		16pcs		v		4pcs



				
① 1pc	② 1pc	③ 1pc	④ 2pcs	⑤ 1pc
				
⑥ 8pcs	⑦ 2pcs	⑧ 4pcs	⑨ 2pcs	⑩ 2pcs
				
⑪ 1pc	⑫ 1pc	⑬ 1pc	⑭ 1pc	

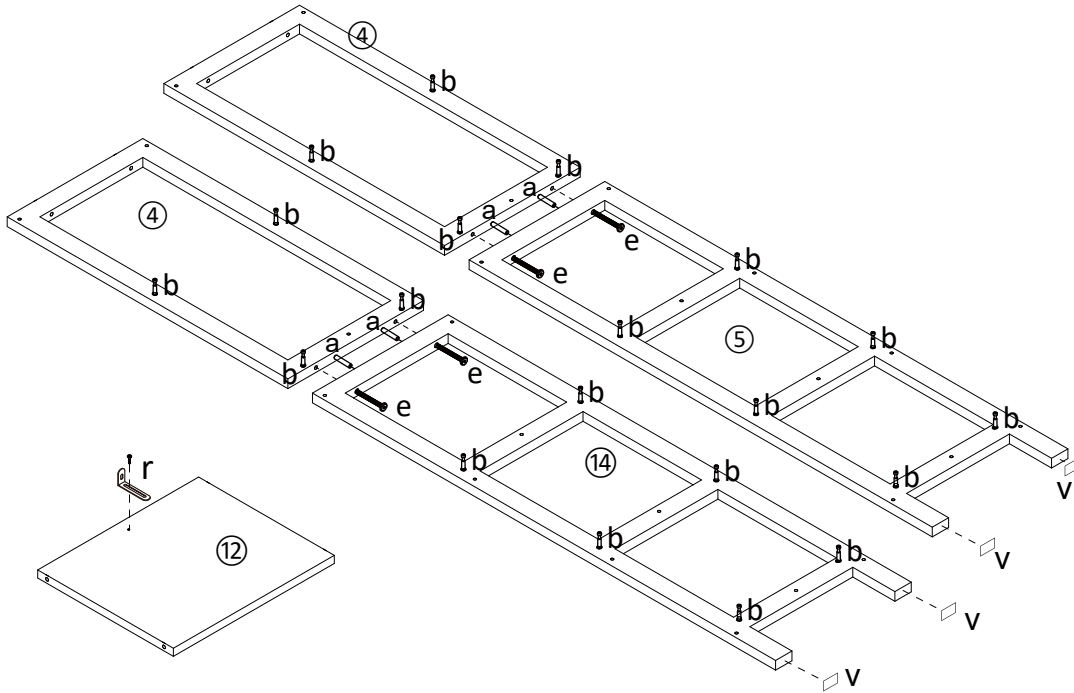

Do not tighten the screws fully during assembly.
Fully tighten screws after the final assembly steps

step 1  bx20  rx1  ex4  ax4  vx4





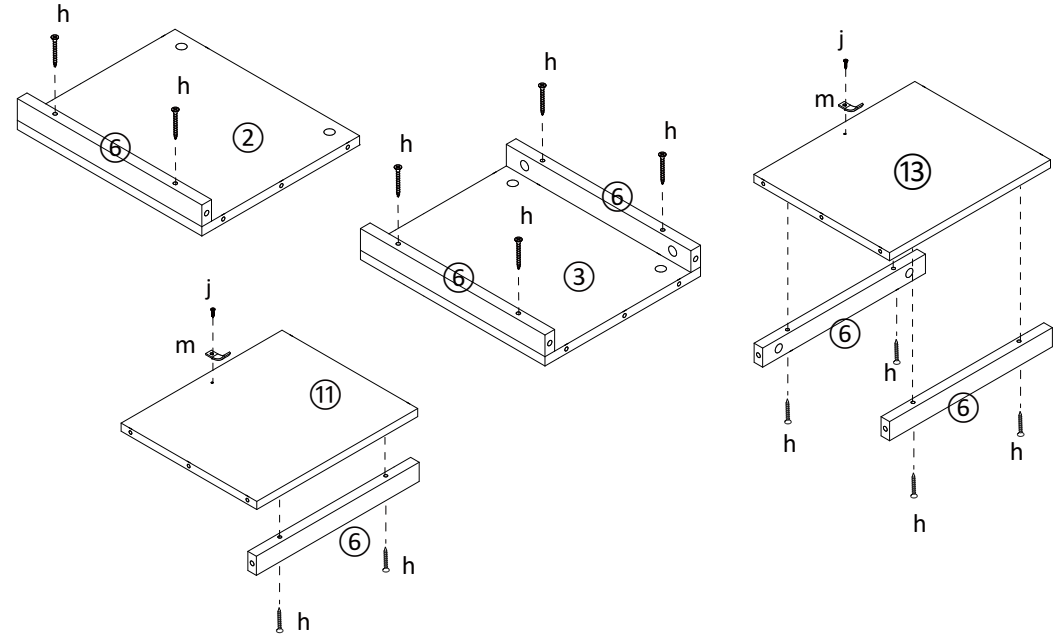

step 2  hx12  jx2  mx2

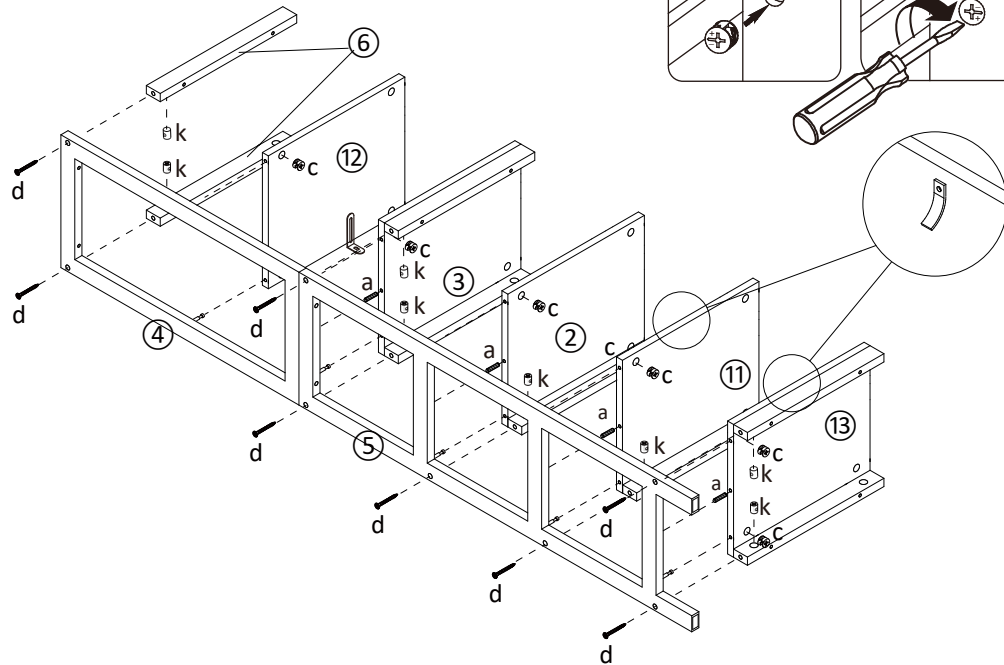
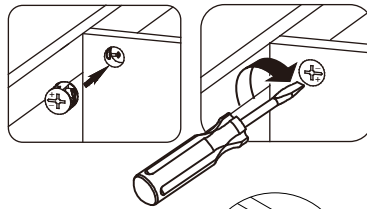

step 3  cx10  dx8  kx8  ax4



step 4  cx10  dx8  kx8  ax4

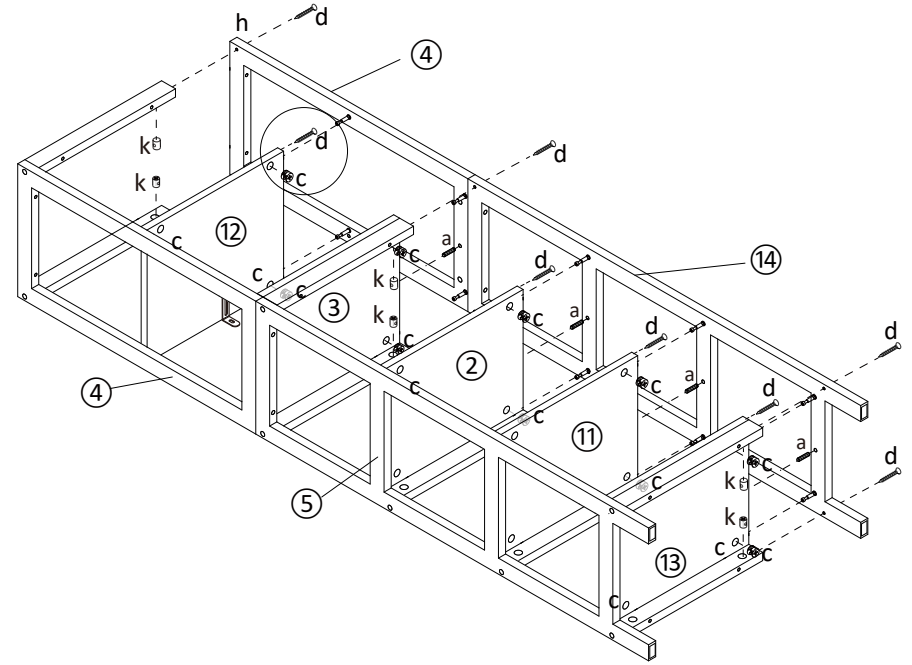

step 5

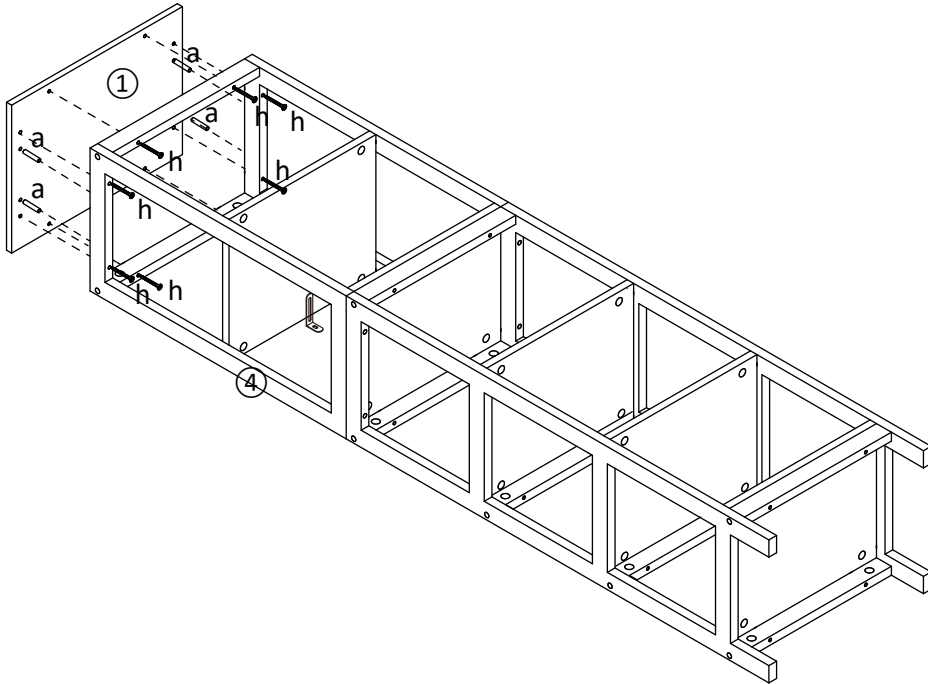

step 6

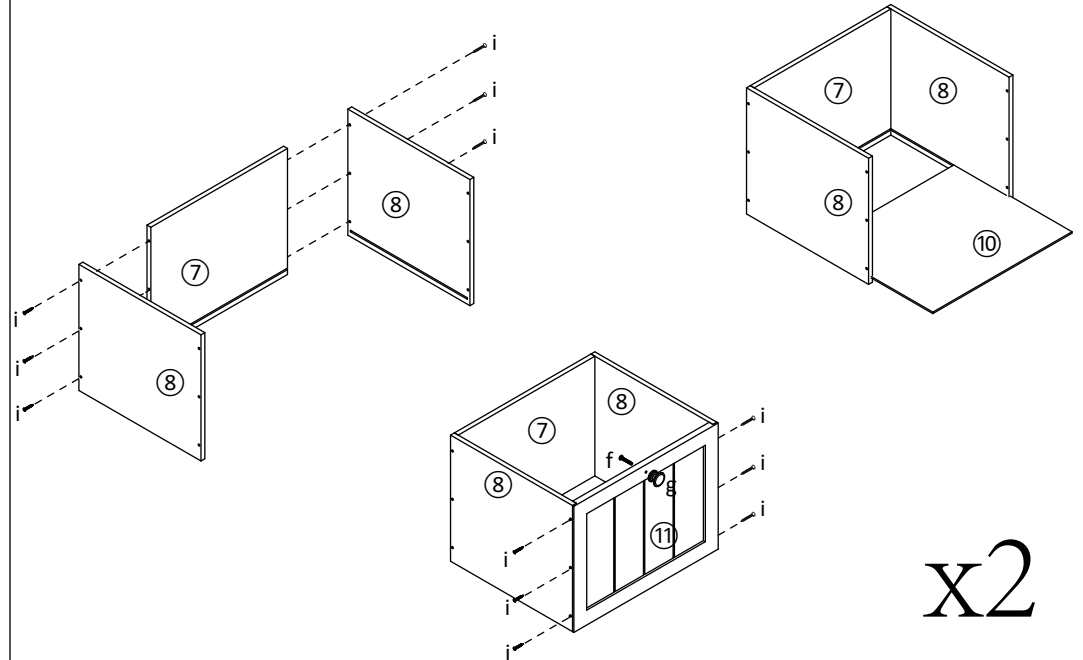
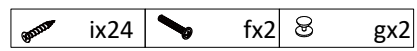

step 7

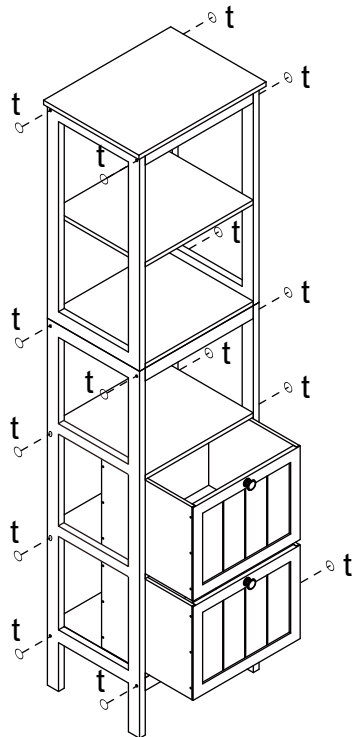
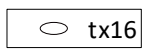

step 8

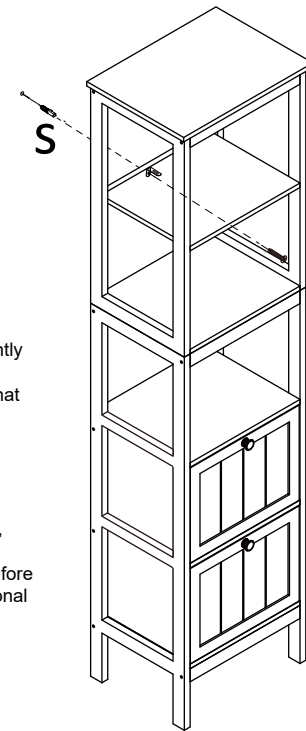

Warning:

- It is strongly recommended that this product is permanently fixed to the wall.
 - Please seek professional advice if you are in doubt of what fixing device to use.
 - Regularly check that anchors are securely maintained.
 - Stability of tall items may be affected by thick pile carpet or uneven floors.
 - Do not place unanchored televisions on cabinet.
- Caution: for your safety when attaching the anchor fixings, please note the following:
- Check any electrical wires or plumbing inside the wall before drilling any holes (if you are unsure please seek professional advice from a qualified tradesperson).



WARNING: PLEASE SECURE YOUR FURNITURE WITH THE SUPPLIED WALL FIXING. SCAN THE CODE FOR MORE INFORMATION.

