

Assembly Instruction

CARE INSTRUCTIONS:









TO BE ASSEMBLED ON A CLEAN, DRY AND SMOOTH SURFACE. WIPE CLEAN WITH A SOFT DAMP CLOTH. NEVER USE SCOURERS, ABRASIVES OR CHEMICAL SOLVENTS. CHECK AND TIGHTEN ALL PARTS REGULARLY. KEEP AWAY FROM MOISTURE AND DIRECT SUNLIGHT. STORE IN A DRY PLACE. FOR INDOOR AND DOMESTIC USE ONLY.

WARNING!

DO NOT STAND, SIT OR LEAN ON THIS UNIT. DO NOT USE THIS UNIT AS A STEP LADDER. ENSURE THIS UNIT IS USED ONLY ON A FLAT SURFACE. DO NOT USE THIS UNIT UNLESS ALL BOLTS AND SCREWS ARE FIRMLY SECURED. DO NOT PLACE HOT ITEMS SUCH AS COFFEE CUPS DIRECTLY ON THE SURFACE OF THIS FURNITURE ITEM. KEEP AWAY FROM CHILDREN AND BABIES. THIS PACKAGE CONTAINS SMALL PARTS AND SHARP POINTS. ADULT ASSEMBLY REQUIRED. A MILD ODOUR MAY BE PRESENT WHEN FIRST OPENING THIS CARTON. SIMPLY ALLOW TO AIR OUTSIDE AND THIS WILL FADE. **MAXIMUM SAFE LOAD: 10KGS FOR TOP, 5KGS FOR MIDDLE SHELF.**

1

Hardware List

	A	∅4x35mm	12PCS		E	∅2x16mm	16PCS
	B	∅6x50mm	2PCS		F	∅4x12mm	1PC
	C	∅6x30mm	16PCS		G	28x28x12mm	1PC
	D	15mm	12PCS		H	∅4x35mm ∅6x30mm	1PC

Tools required
(not provided)



Philips Head
Screw Driver



Rubber Mallet

2

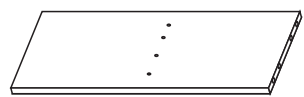
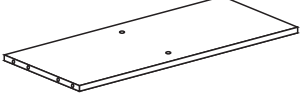
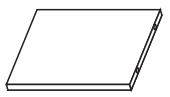
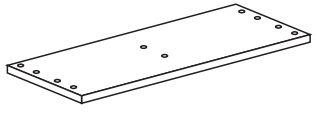
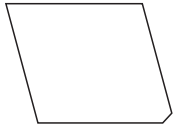
					
1	2PCS	2	1PC	3	2PCS
					
4	2PCS	5	2PCS		

3

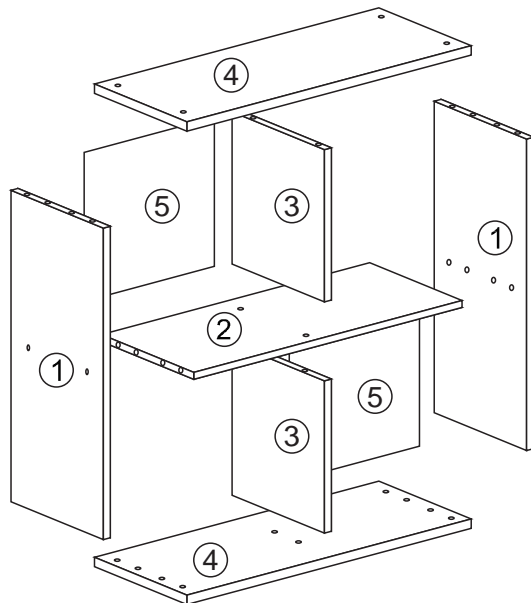

4

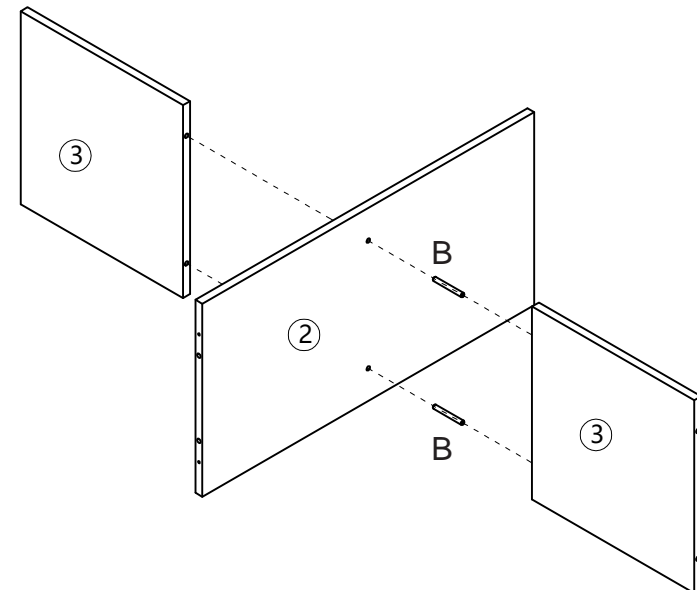

Assembly Instruction

CARE INSTRUCTIONS:

TO BE ASSEMBLED ON A CLEAN, DRY AND SMOOTH SURFACE. WIPE CLEAN WITH A SOFT DAMP CLOTH. NEVER USE SCOURERS, ABRASIVES OR CHEMICAL SOLVENTS. CHECK AND TIGHTEN ALL PARTS REGULARLY. KEEP AWAY FROM MOISTURE AND DIRECT SUNLIGHT. STORE IN A DRY PLACE. FOR INDOOR AND DOMESTIC USE ONLY.

WARNING!

DO NOT STAND, SIT OR LEAN ON THIS UNIT. DO NOT USE THIS UNIT AS A STEP LADDER. ENSURE THIS UNIT IS USED ONLY ON A FLAT SURFACE. DO NOT USE THIS UNIT UNLESS ALL BOLTS AND SCREWS ARE FIRMLY SECURED. DO NOT PLACE HOT ITEMS SUCH AS COFFEE CUPS DIRECTLY ON THE SURFACE OF THIS FURNITURE ITEM. KEEP AWAY FROM CHILDREN AND BABIES. THIS PACKAGE CONTAINS SMALL PARTS AND SHARP POINTS. ADULT ASSEMBLY REQUIRED. A MILD ODOUR MAY BE PRESENT WHEN FIRST OPENING THIS CARTON. SIMPLY ALLOW TO AIR OUTSIDE AND THIS WILL FADE. **MAXIMUM SAFE LOAD: 10KGS FOR TOP, 5KGS FOR MIDDLE SHELF.**

