

MINI BLOCK BRONTOSAURUS



10+
YEARS

1968 PCS

Difficulty index:



MINI BLOCK BRONTOSAURUS

keycode:43341016
ADULT ASSISTANCE IS RECOMMENDED.
PRODUCT MAY SLIGHTLY FROM IMAGE SHOWN.

 **WARNING:**
CHOKING HAZARD - SMALL PARTS.
NOT FOR CHILDREN UNDER 3 YEARS.

10+
YEARS

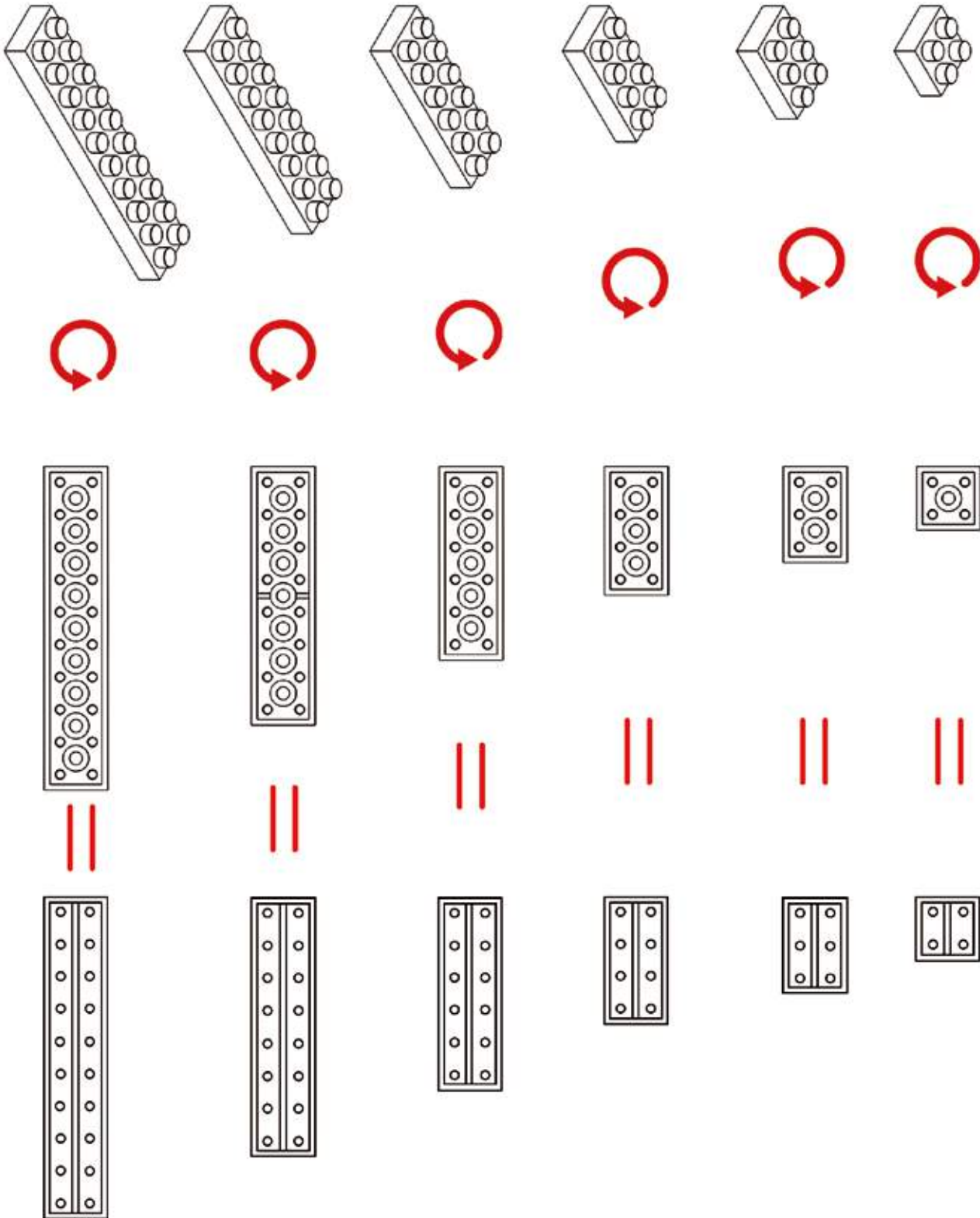

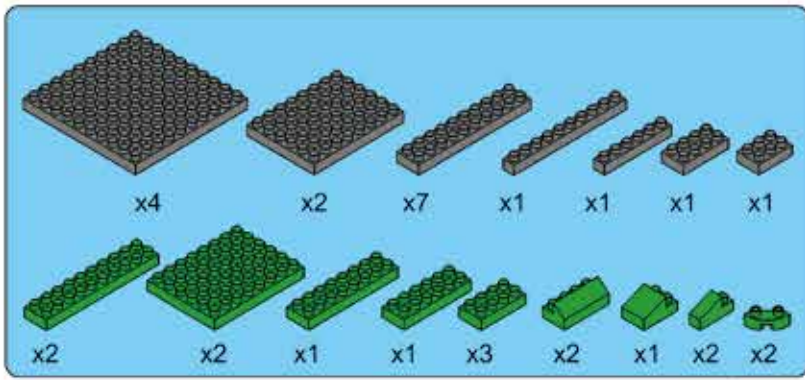

1

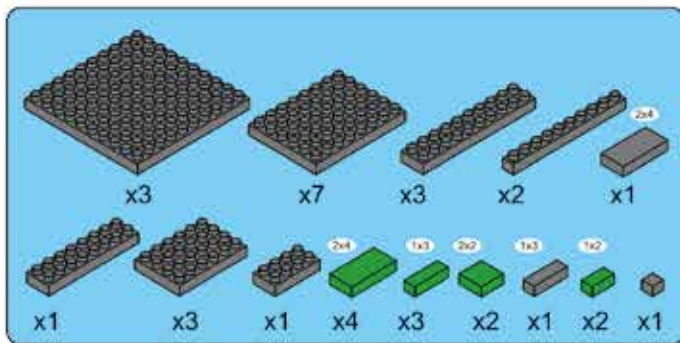
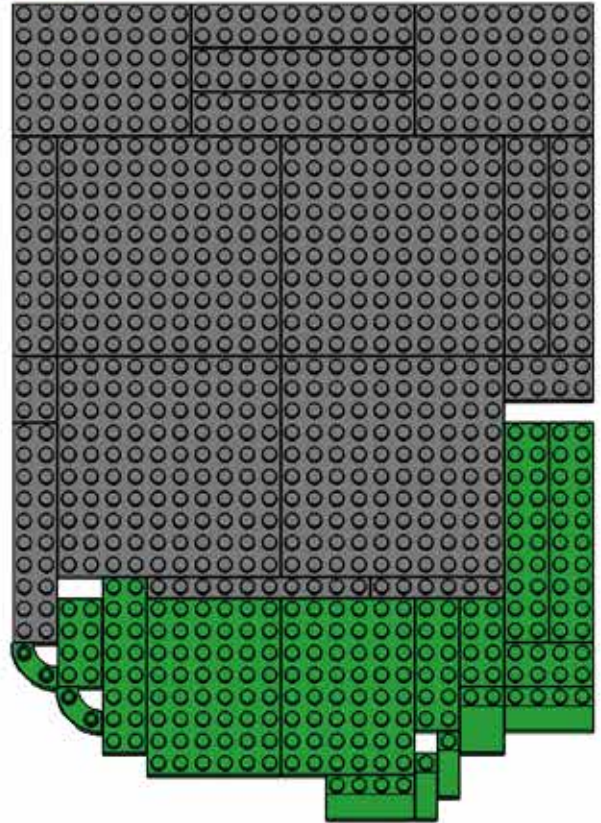

2

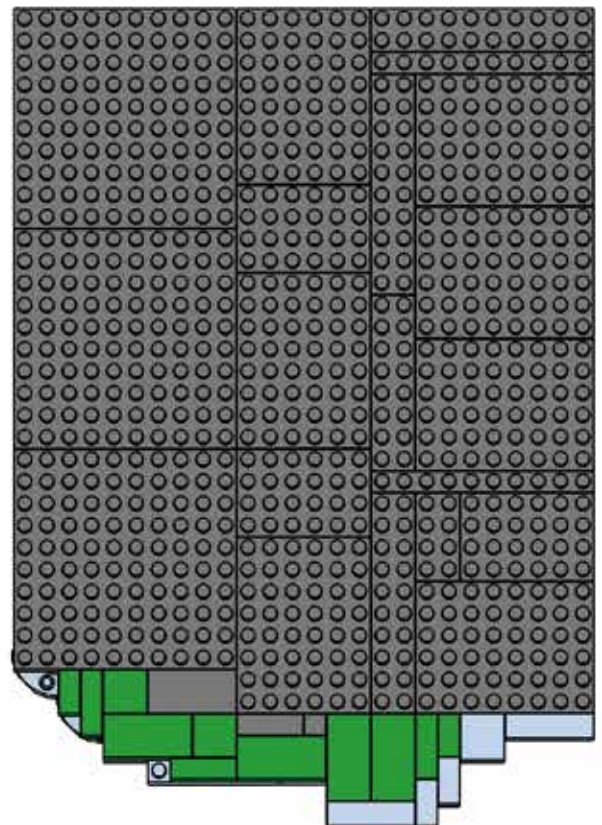

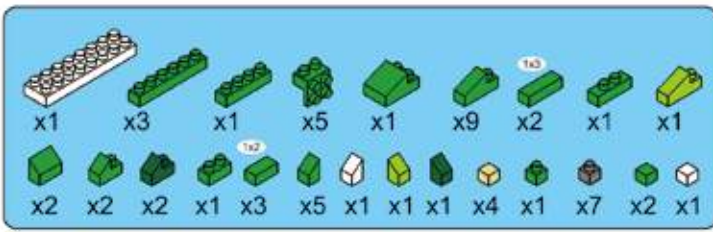

3

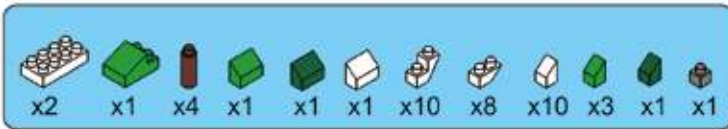
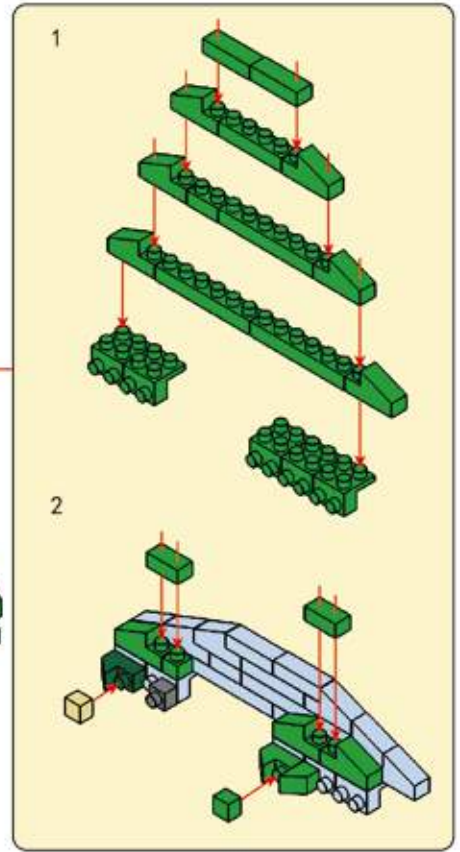
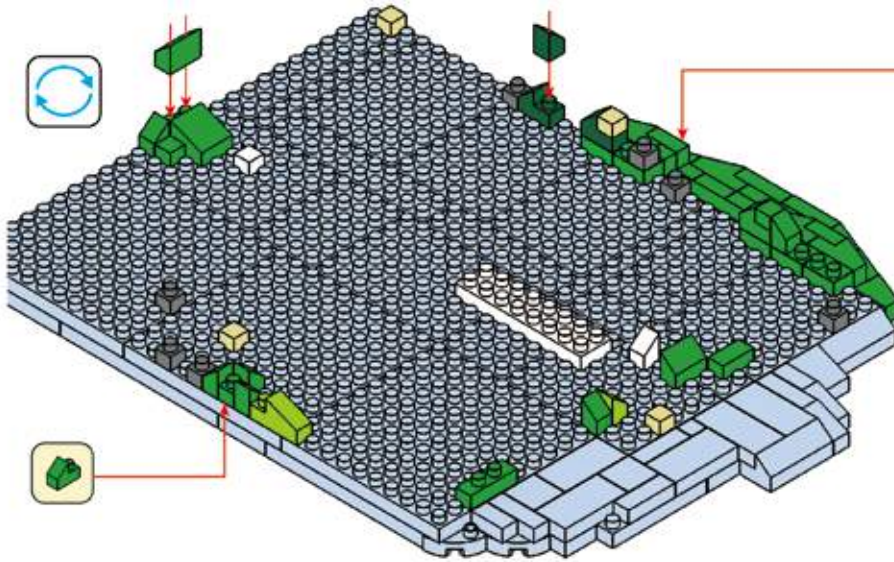

4

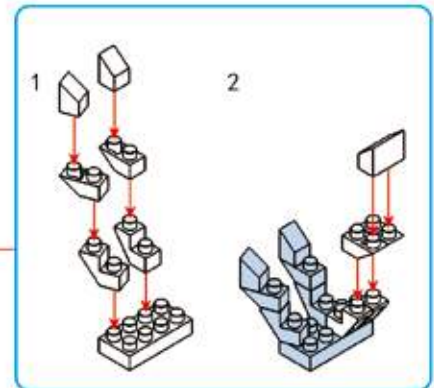
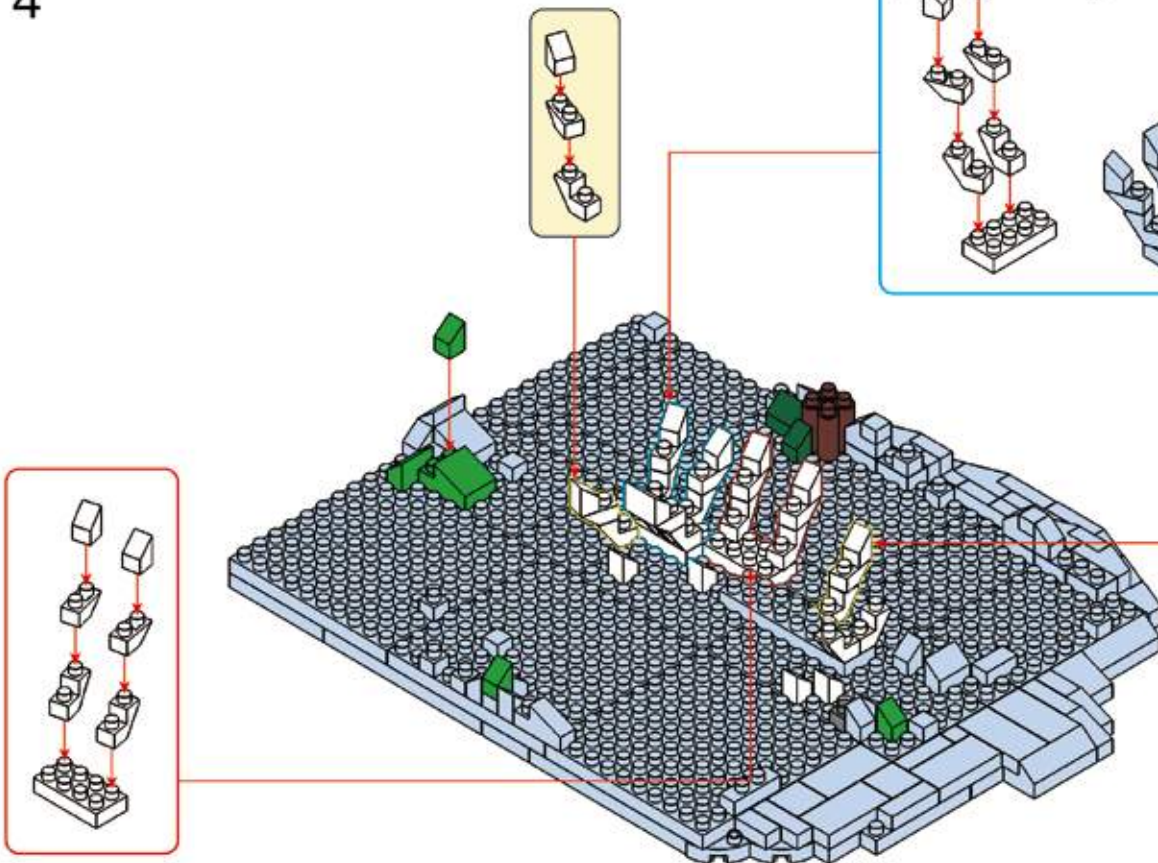

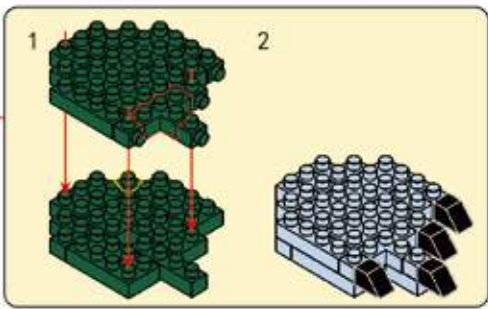
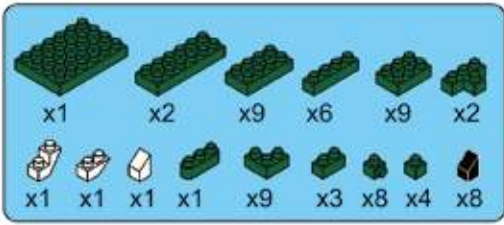

5

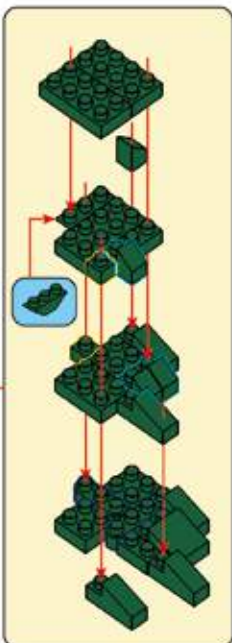
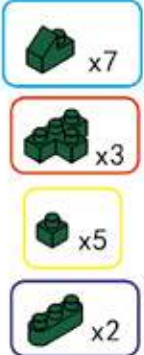
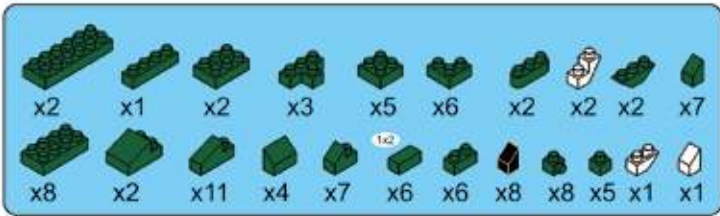
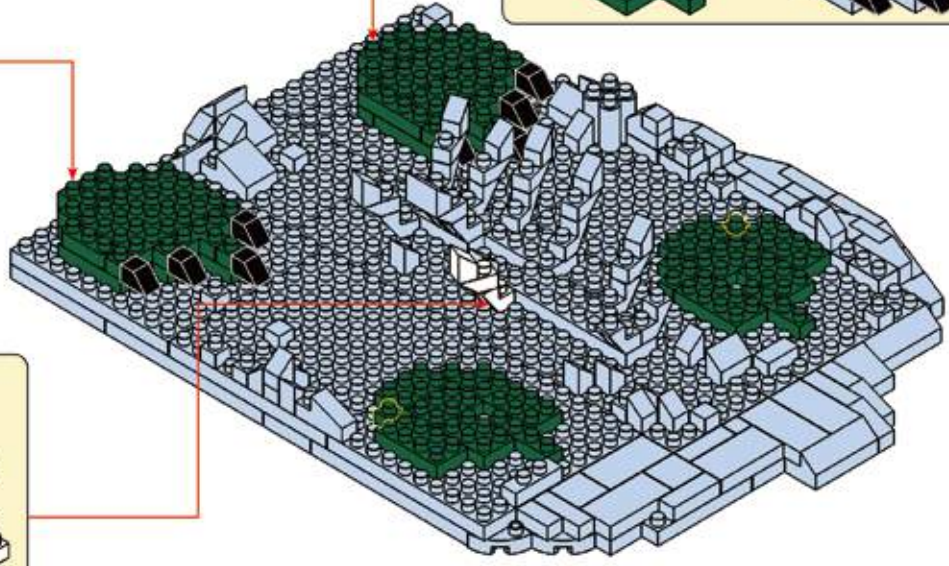
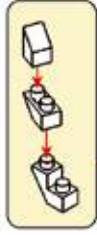
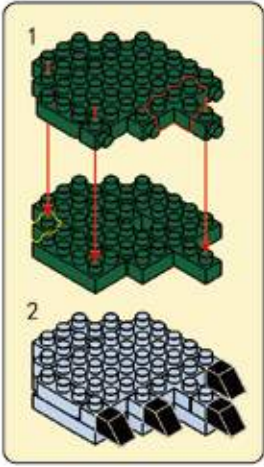

6

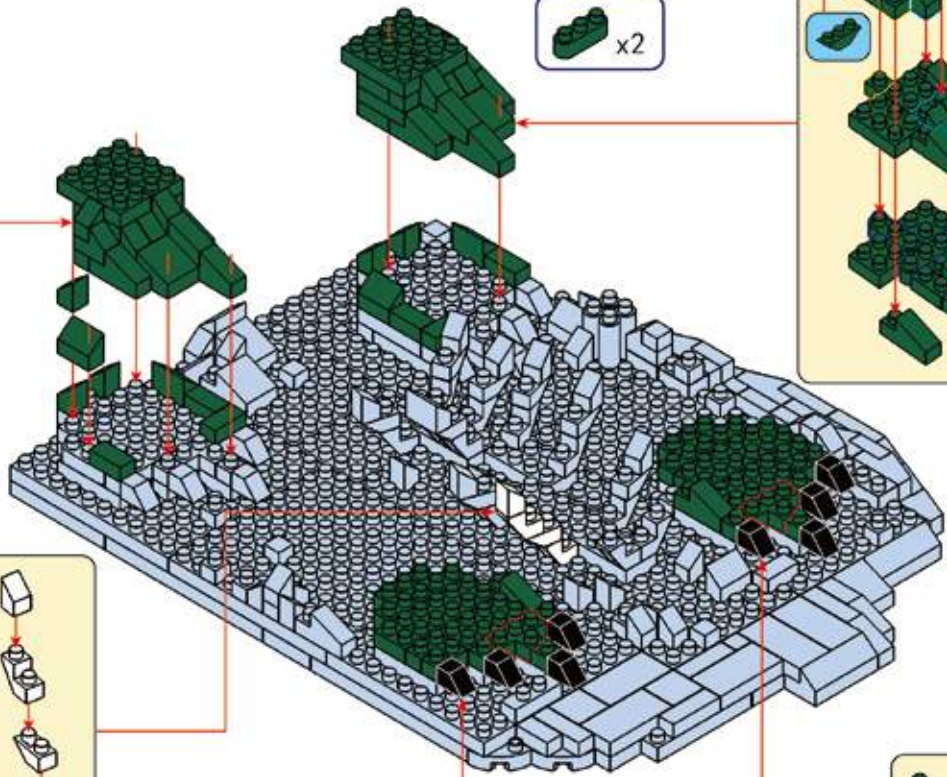
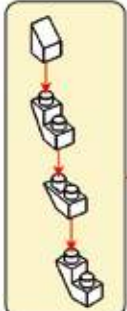
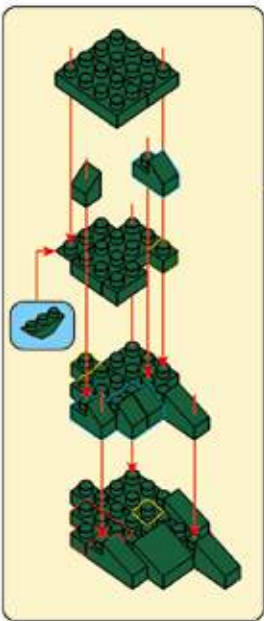

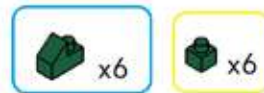
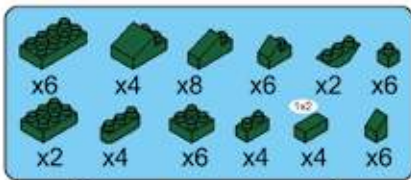

7

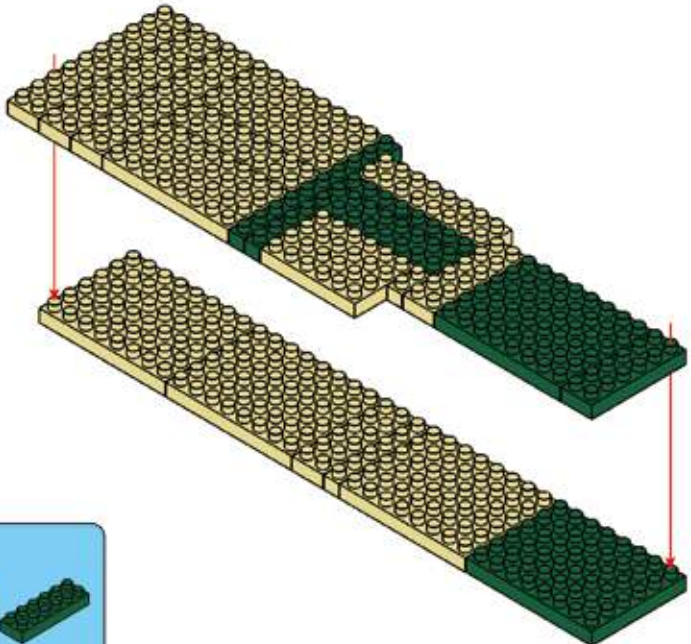
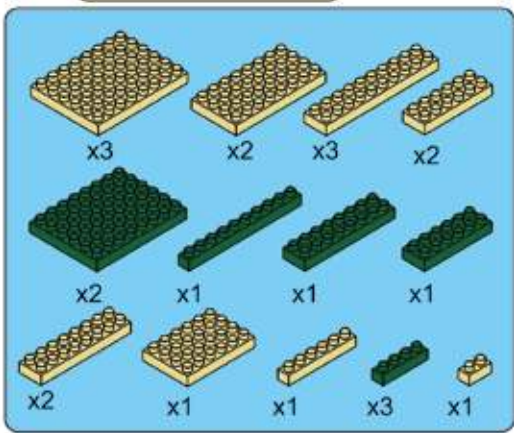
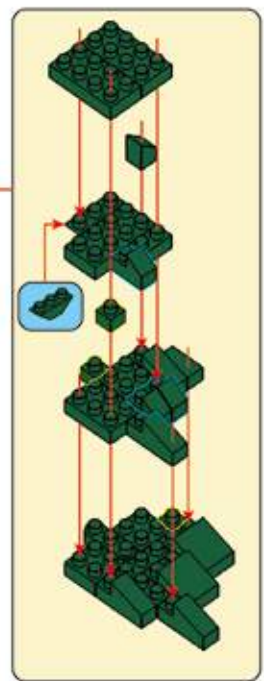
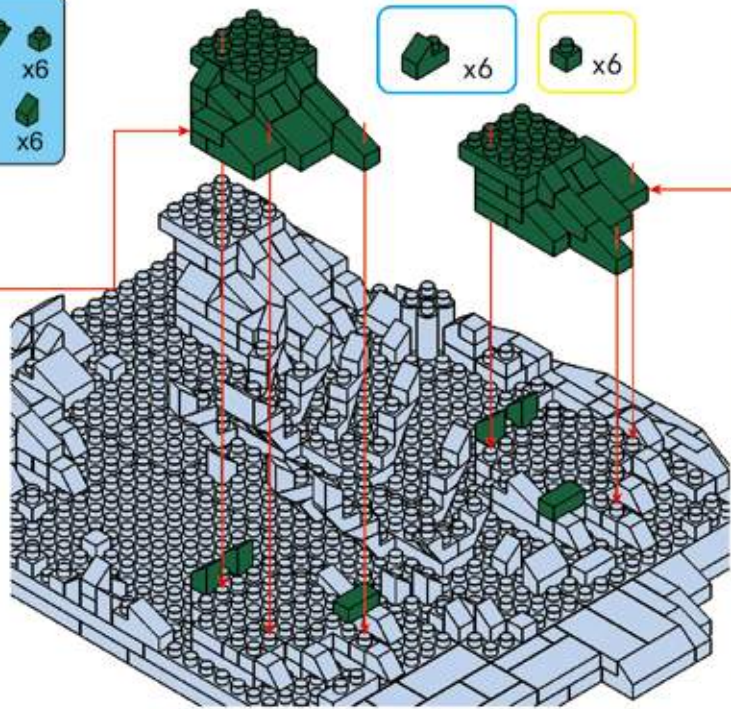
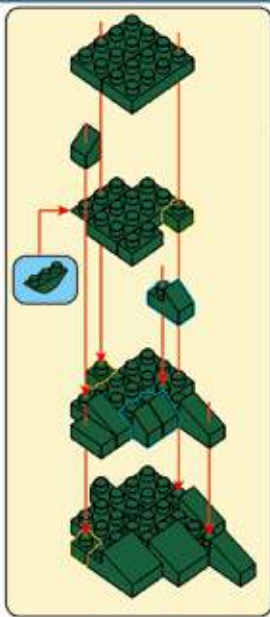

8

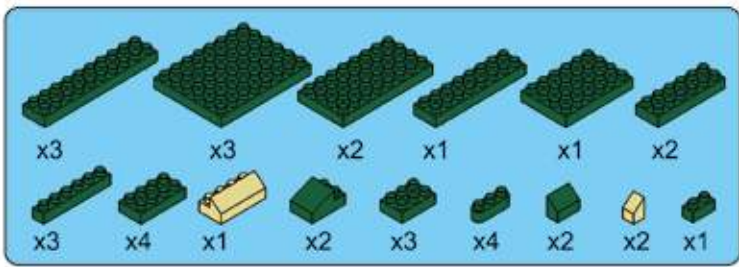

9

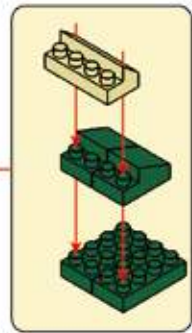
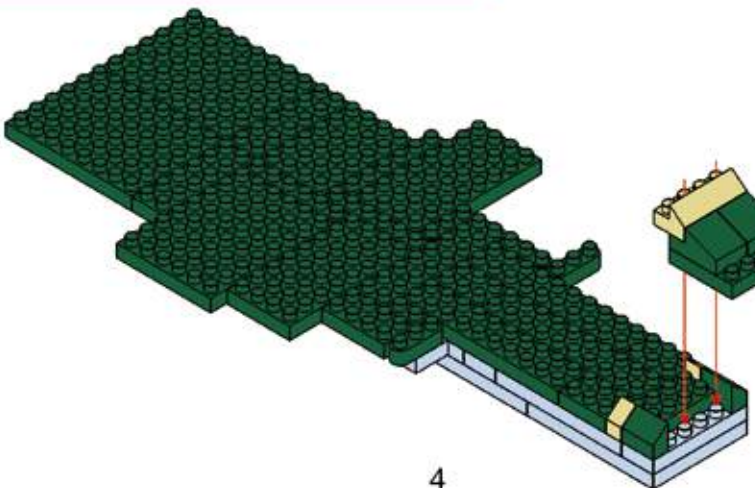

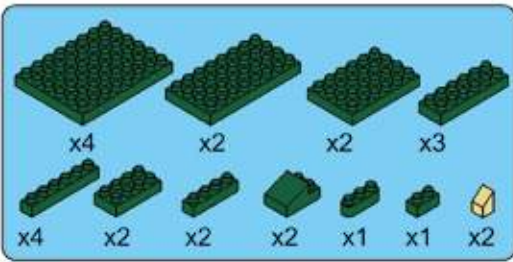

10

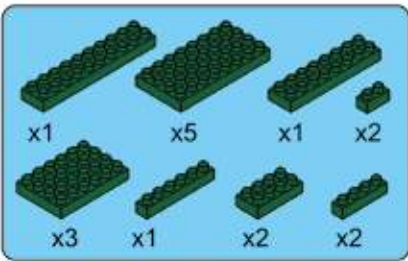
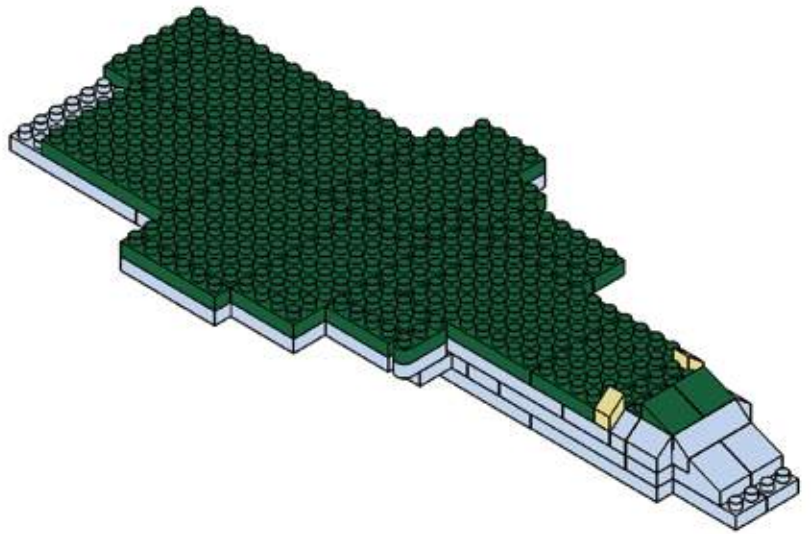

11

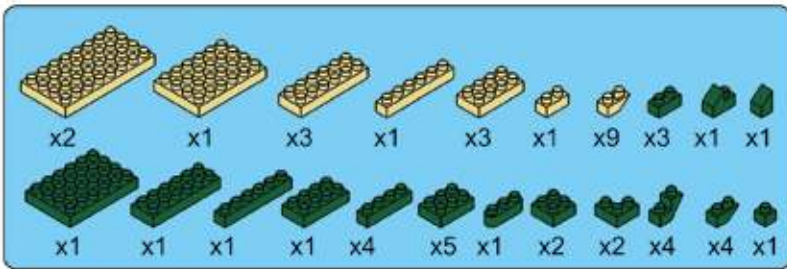
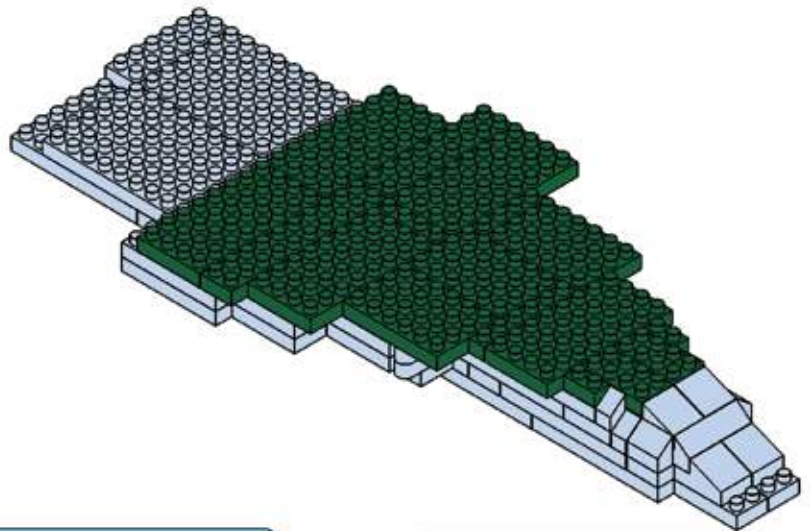

12

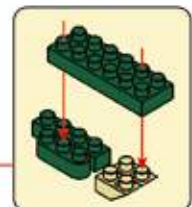
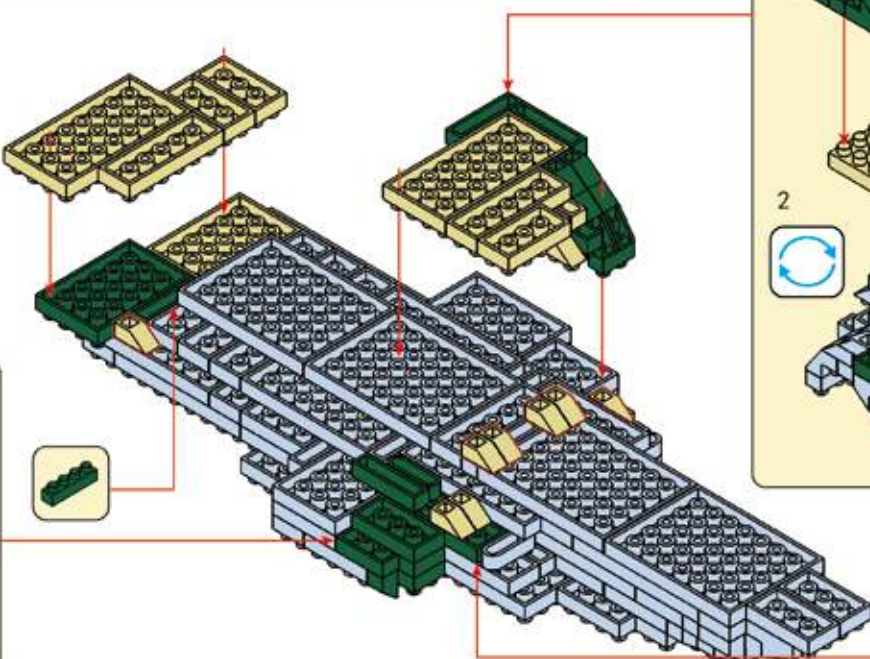
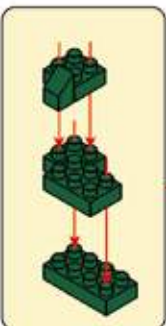
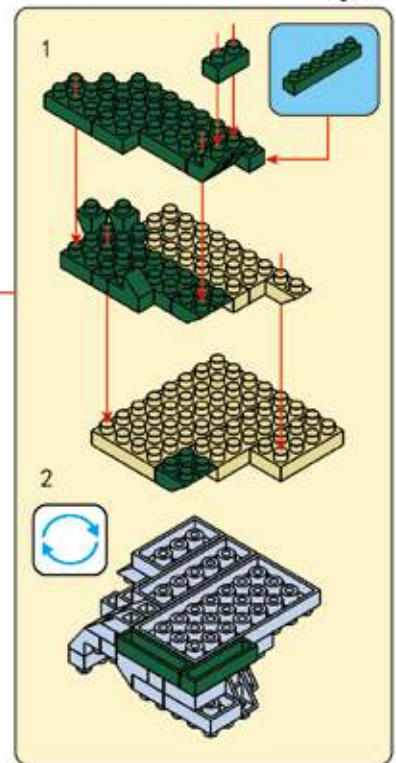

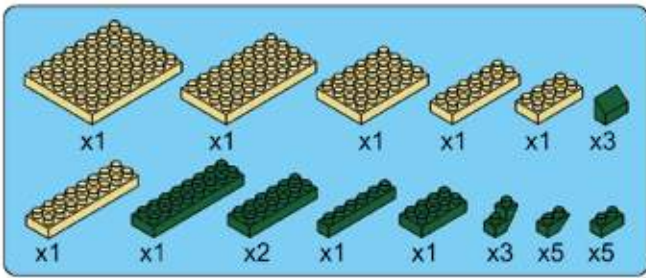

13

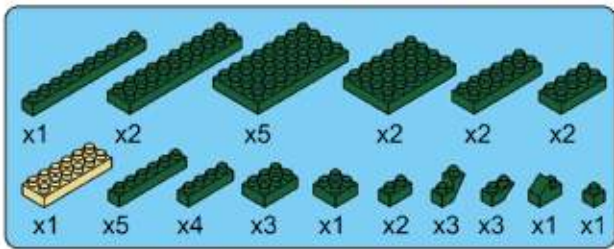
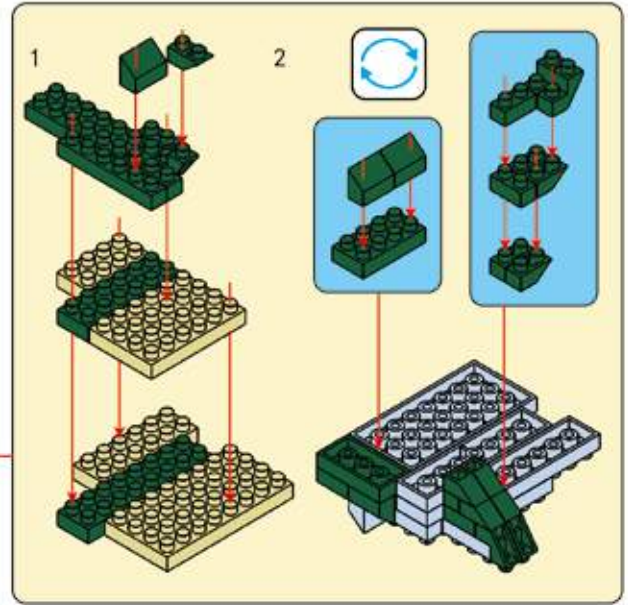
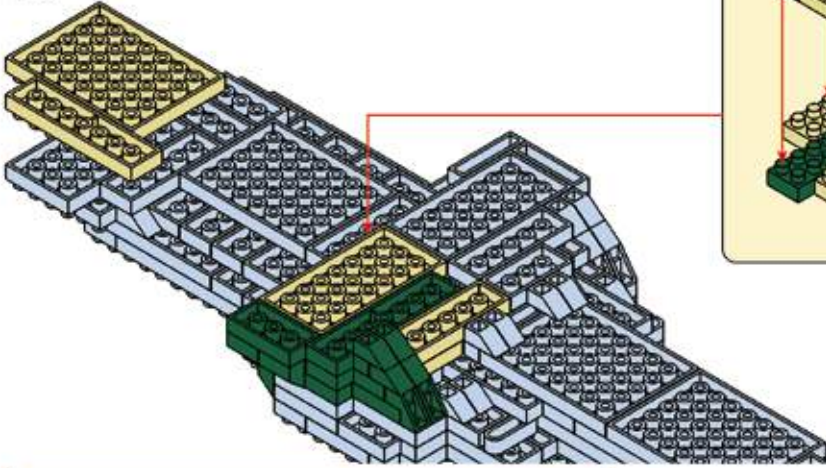

14

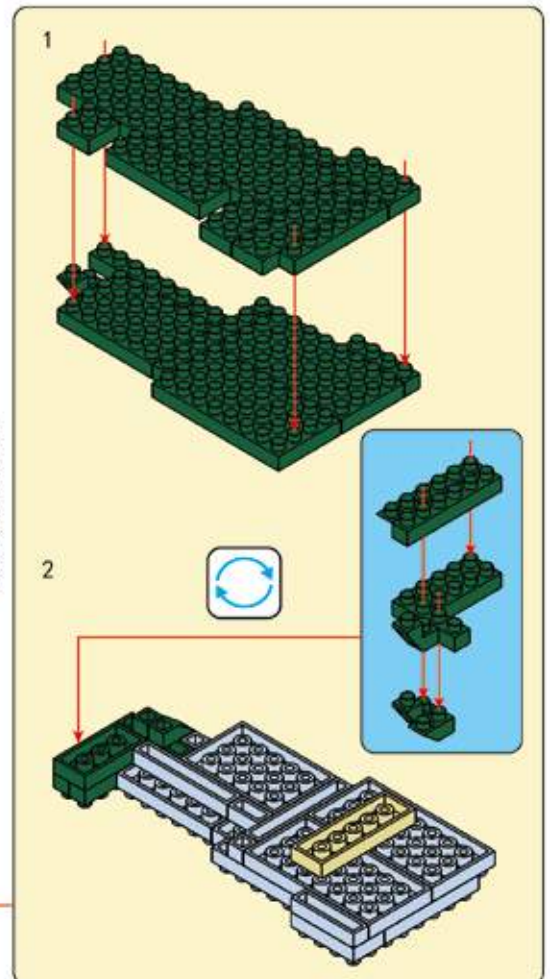
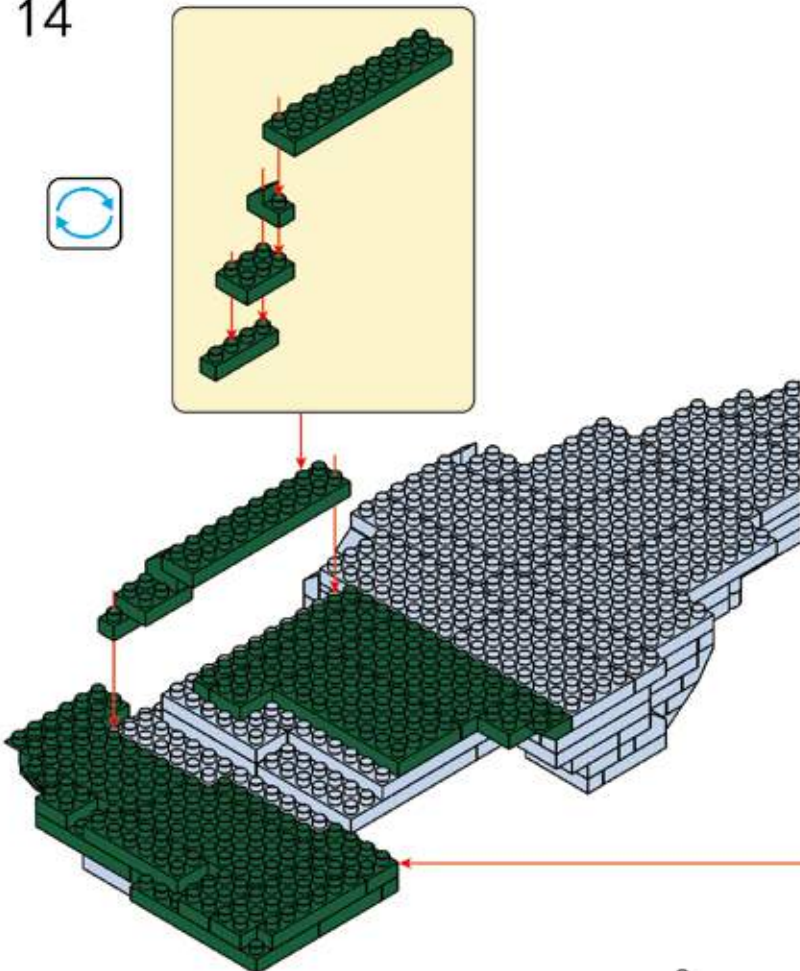

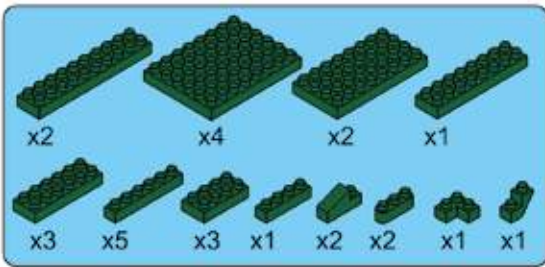

15

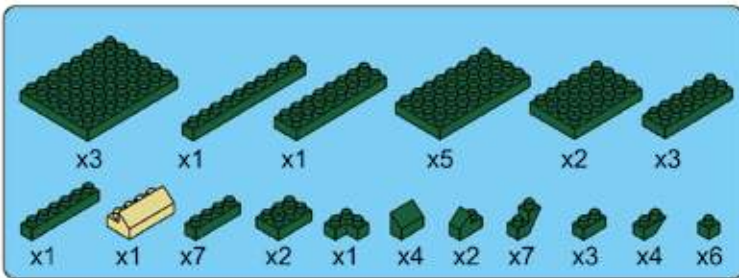
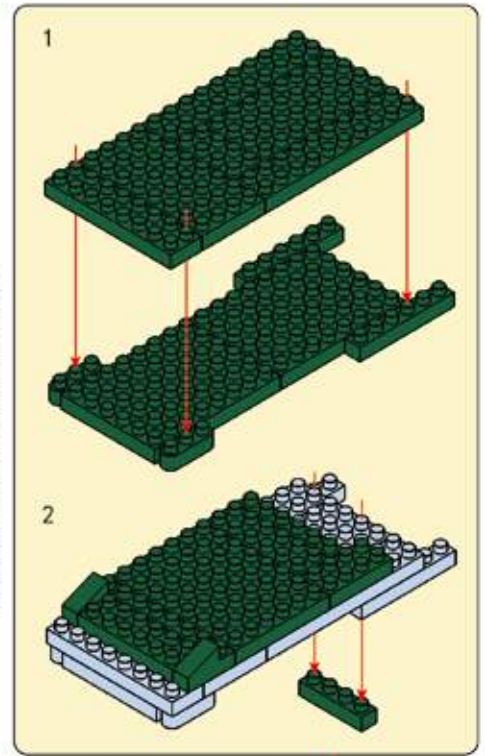
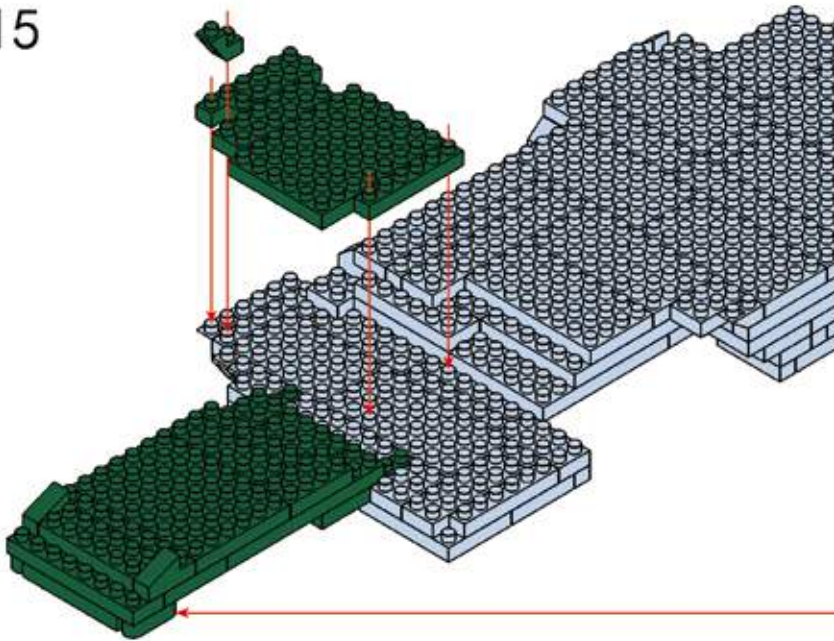

16

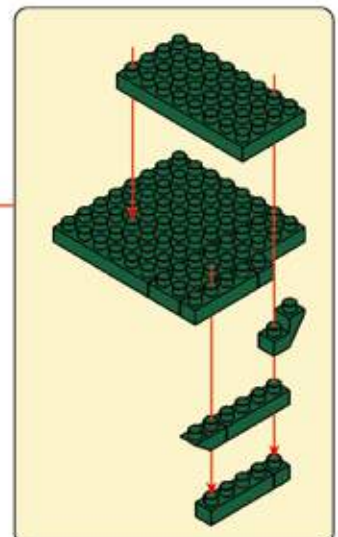
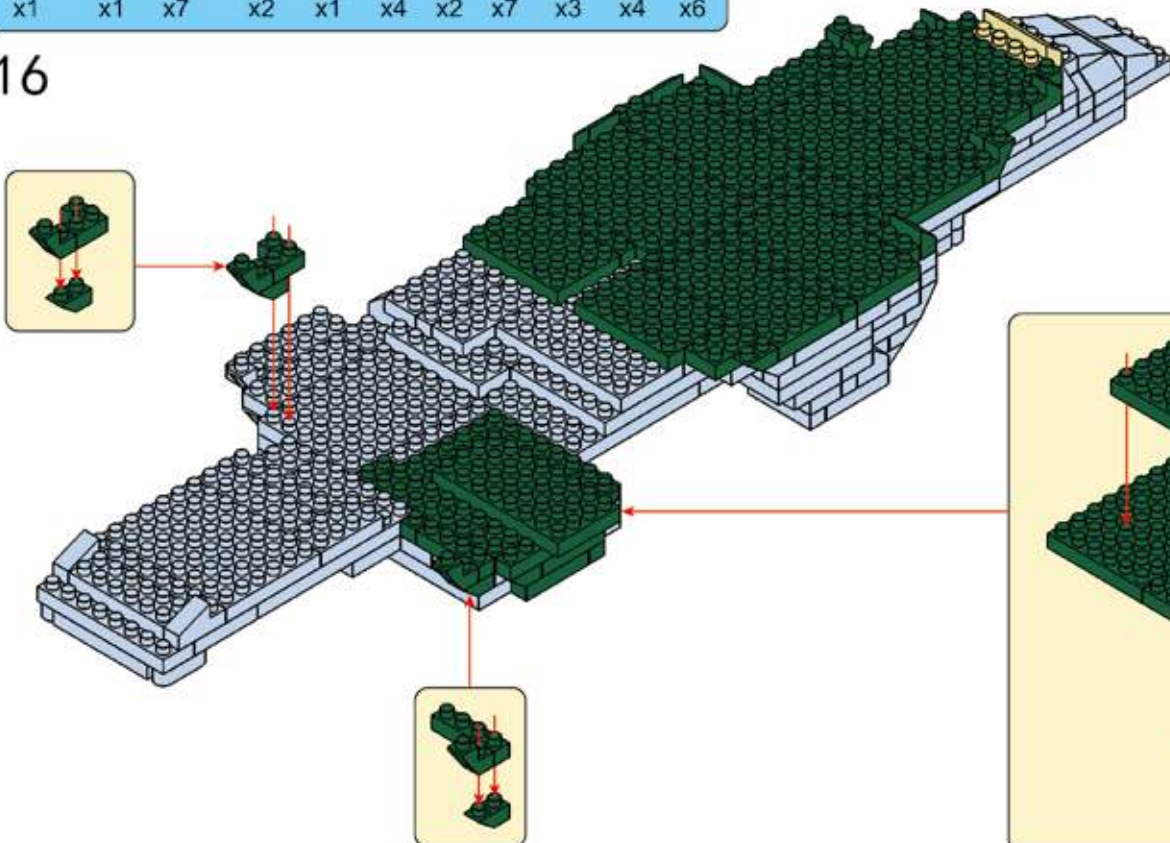

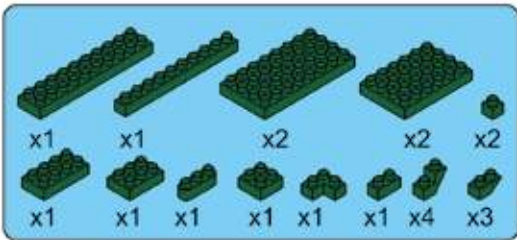

17

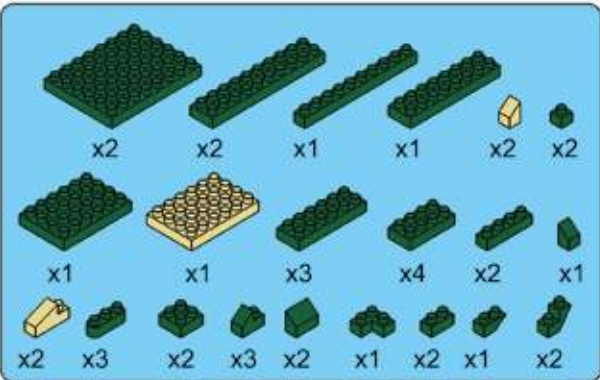
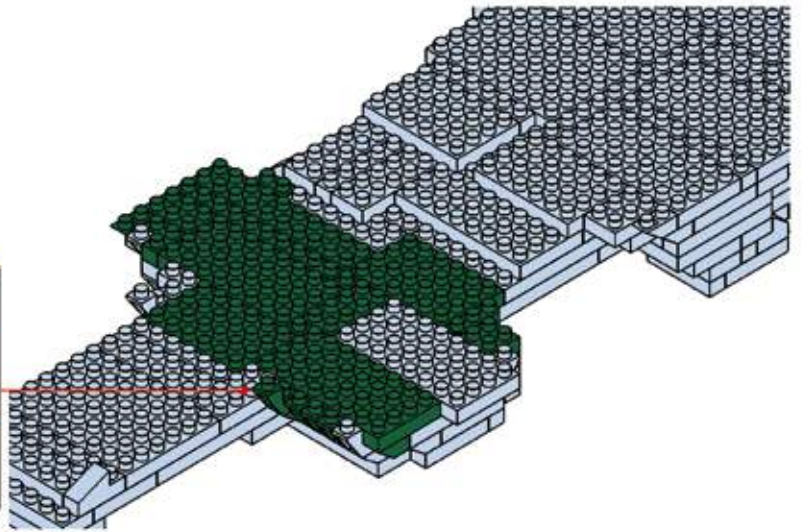
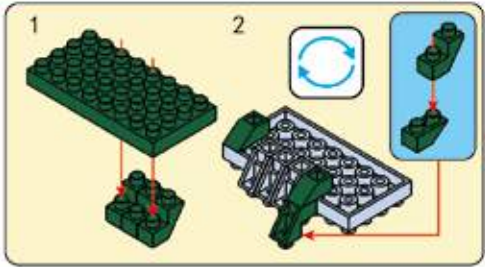

18

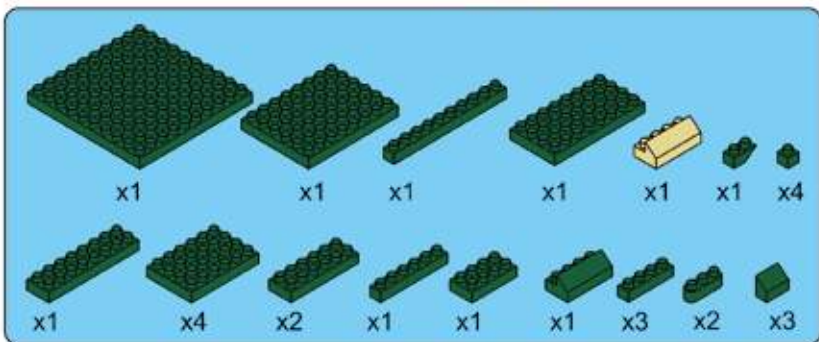
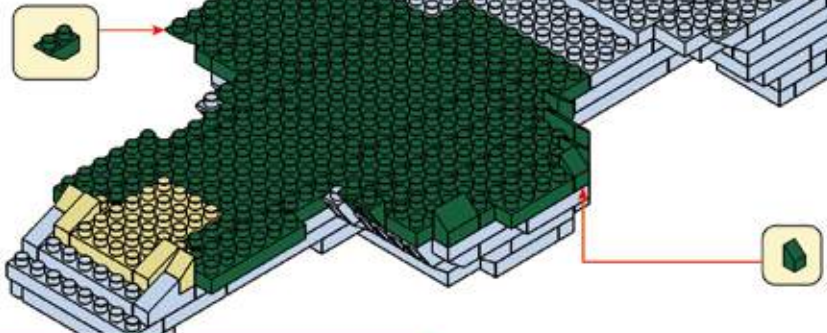

19

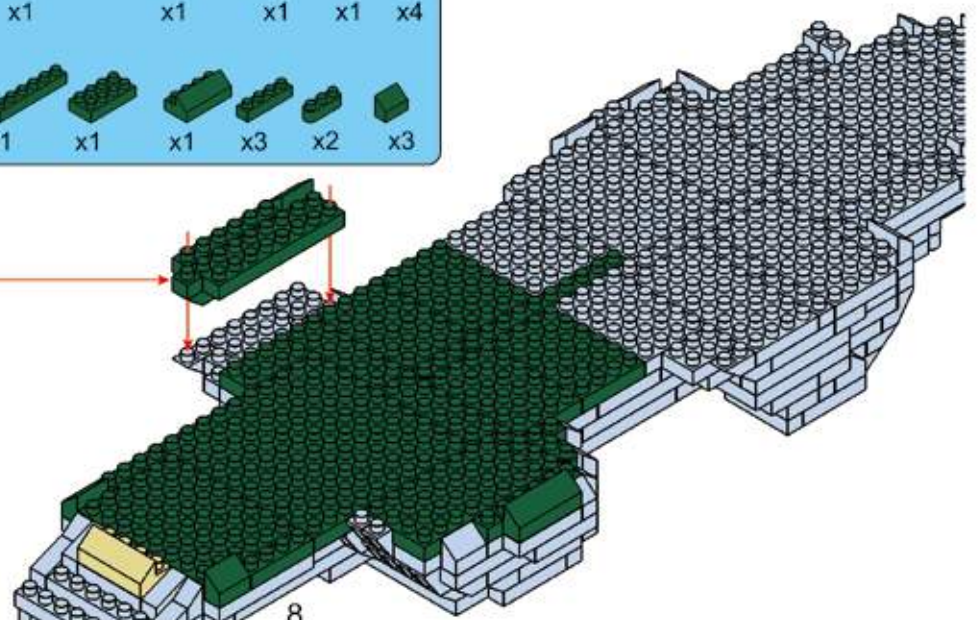
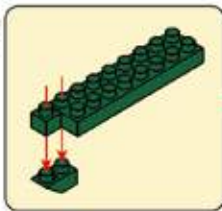

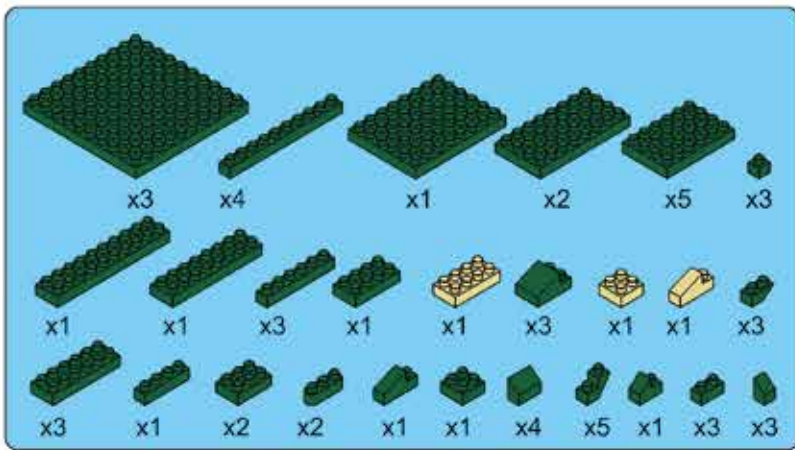

20

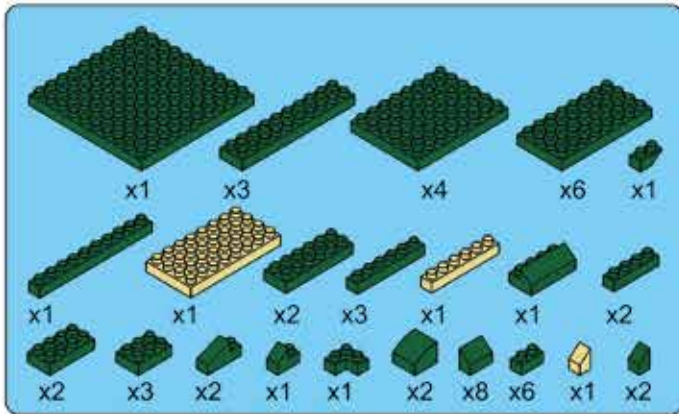
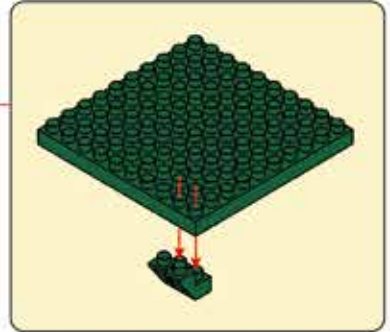
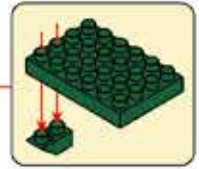
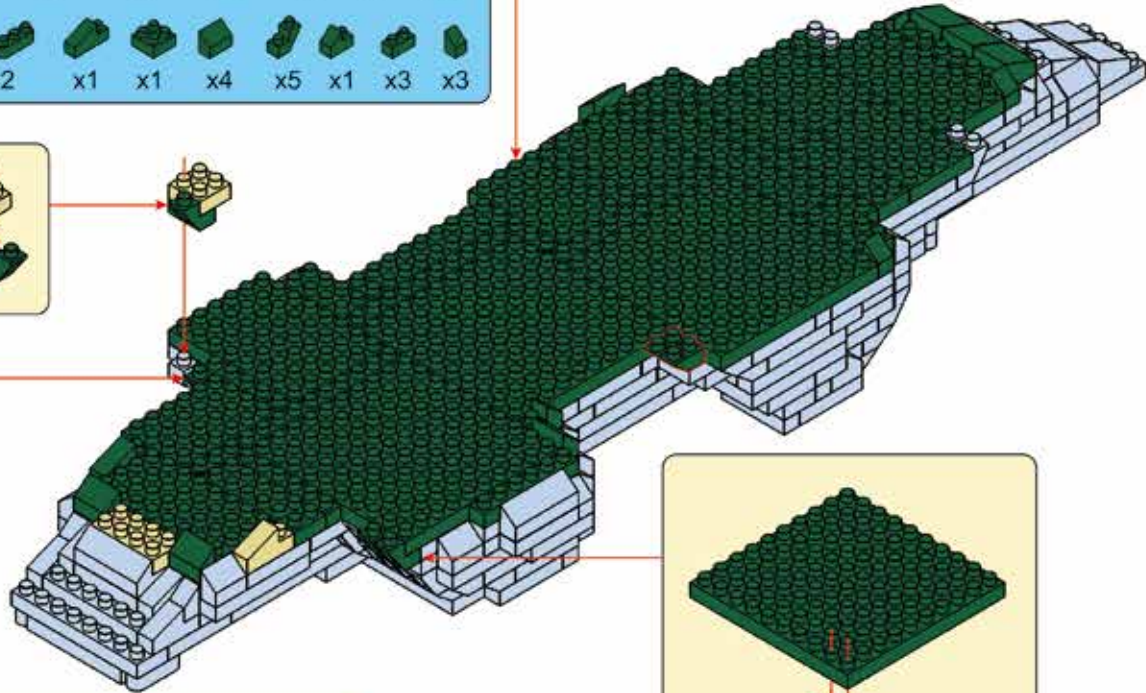
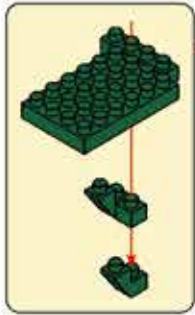
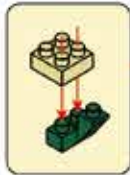

21

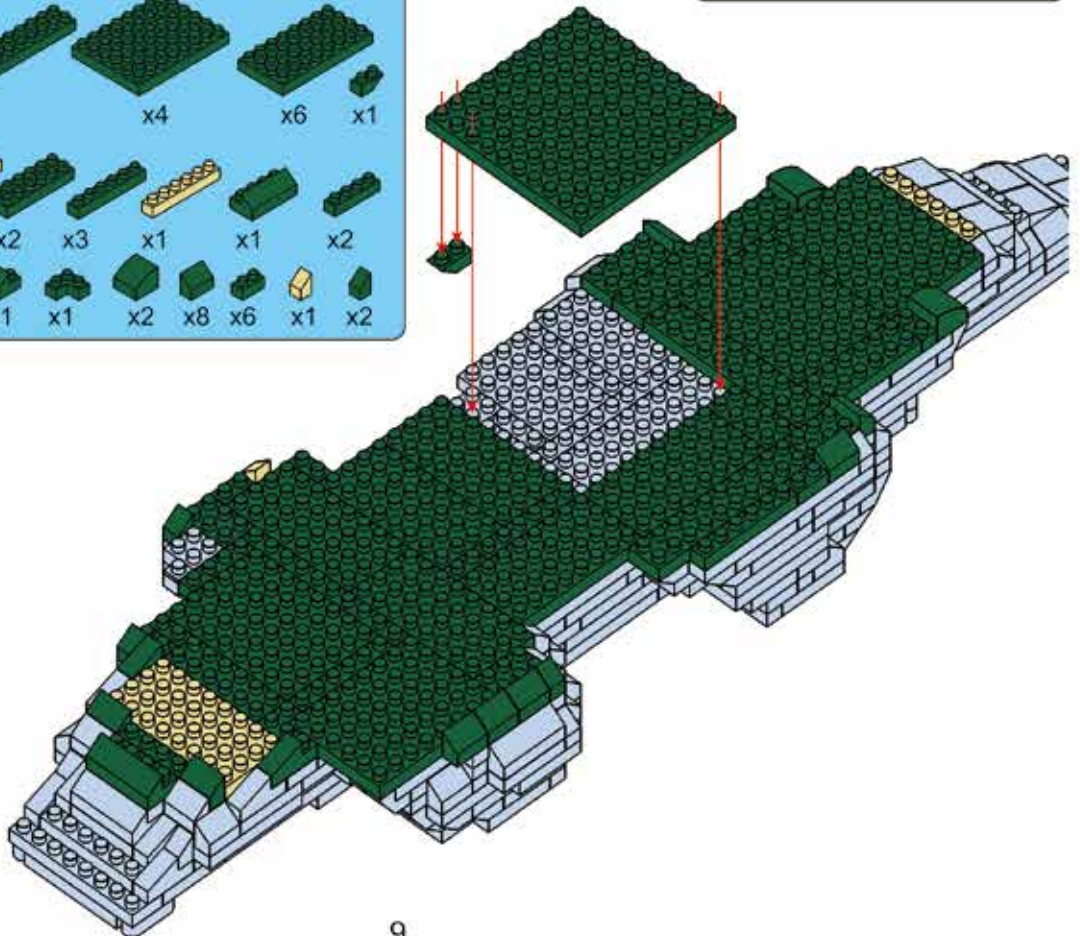

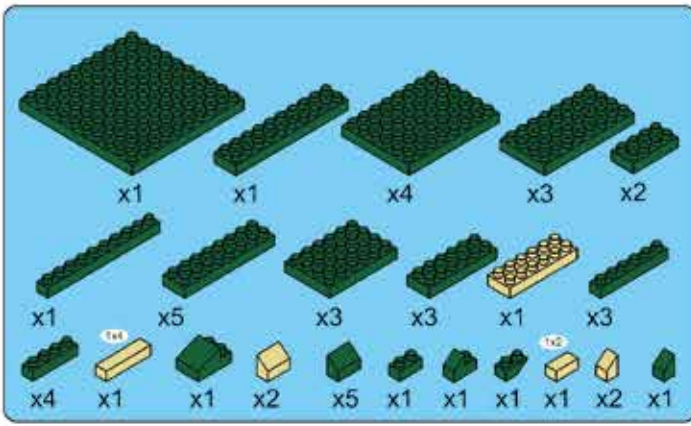

22

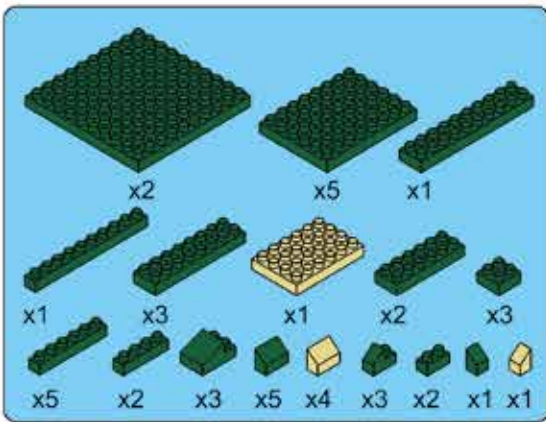
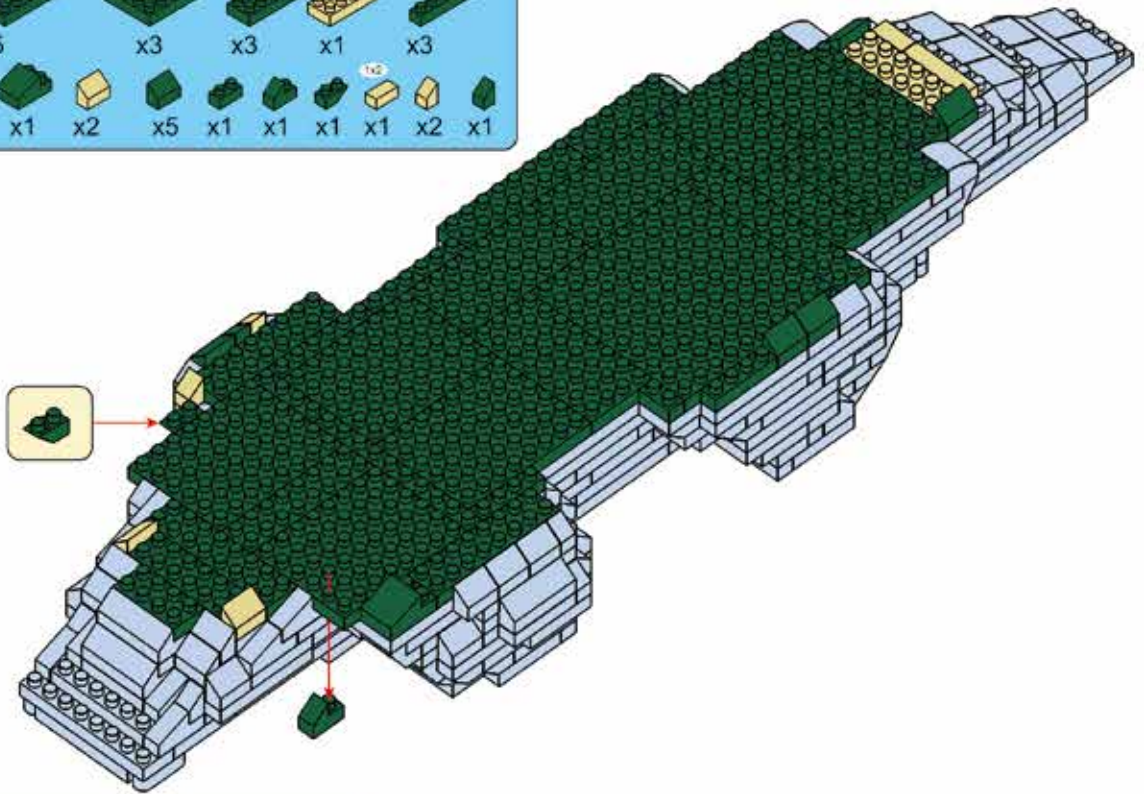

23

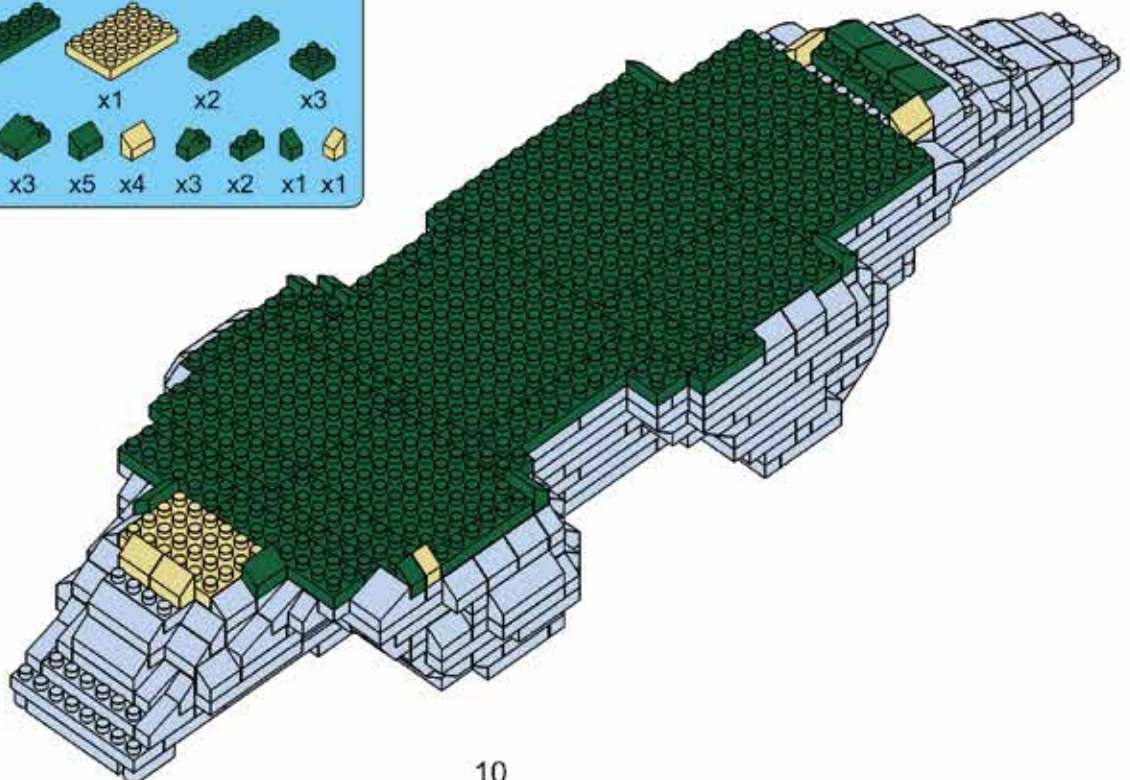

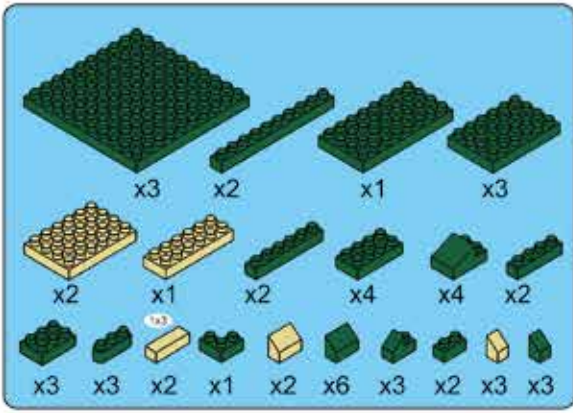

24

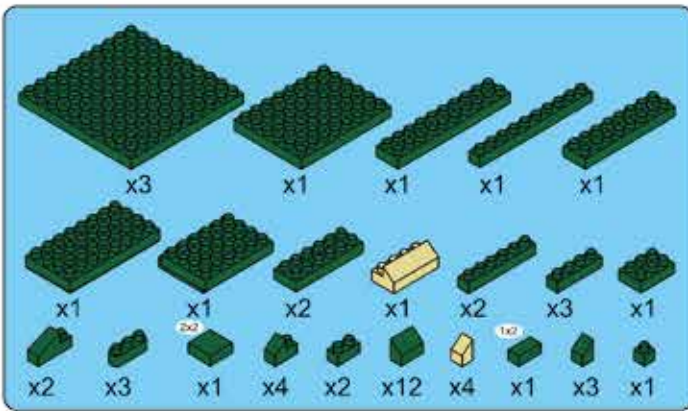
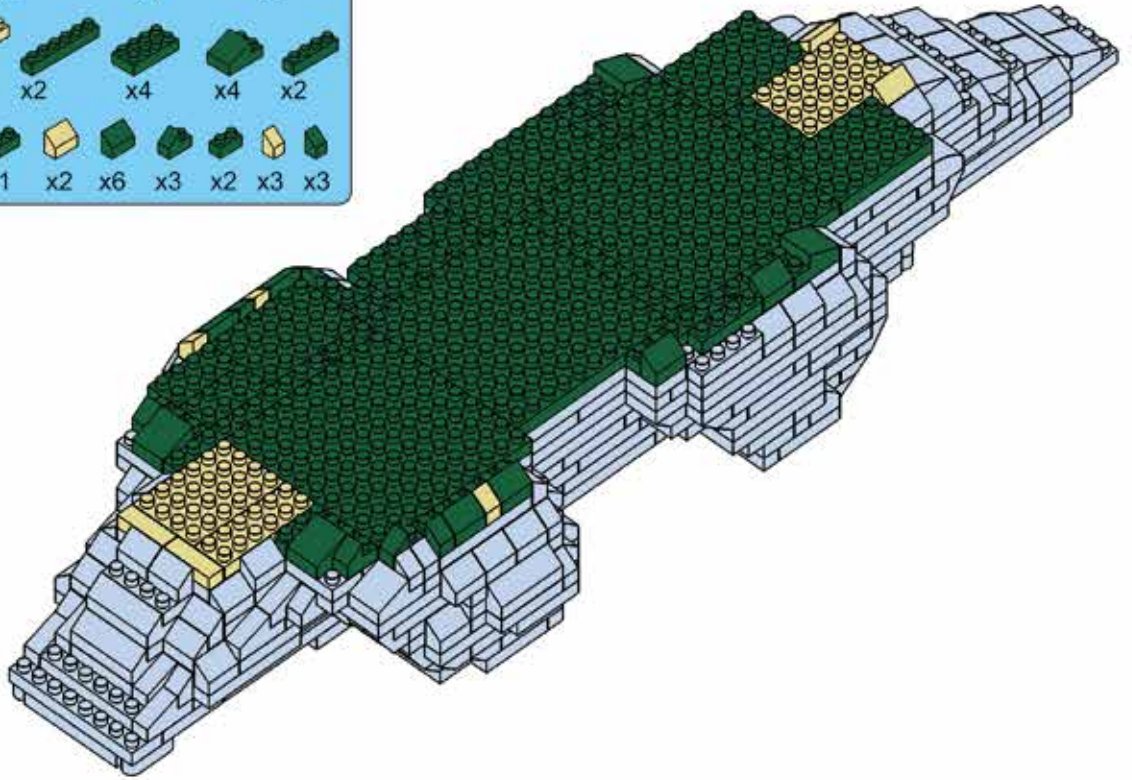

25

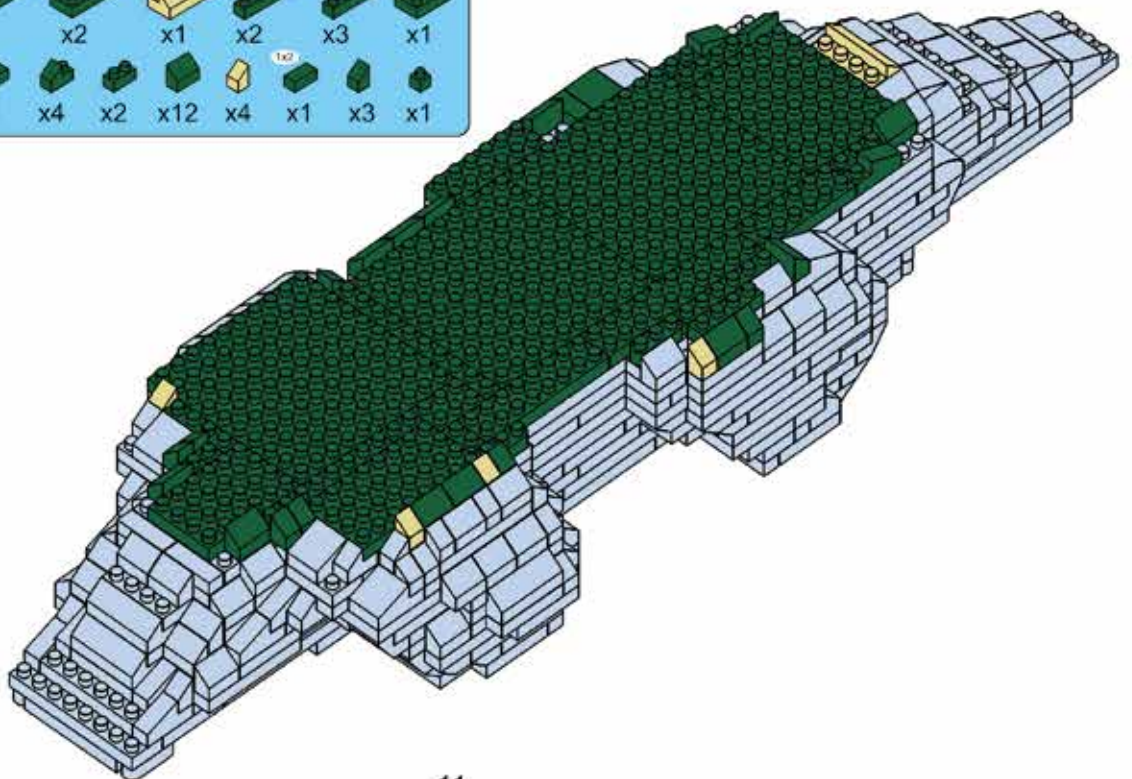

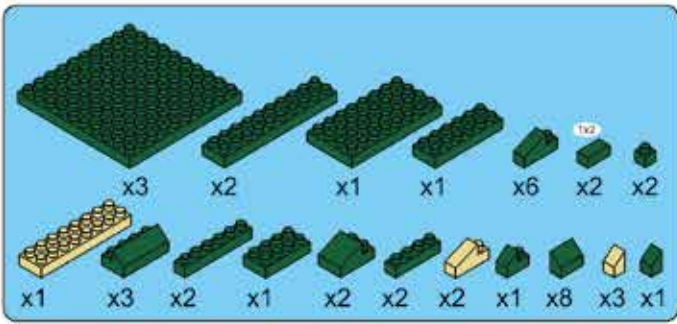

26

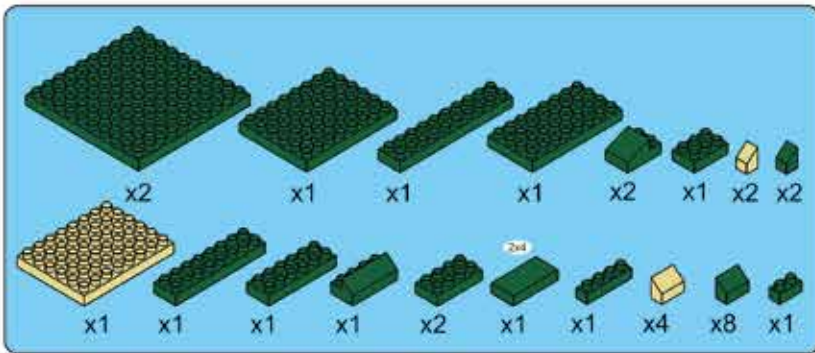
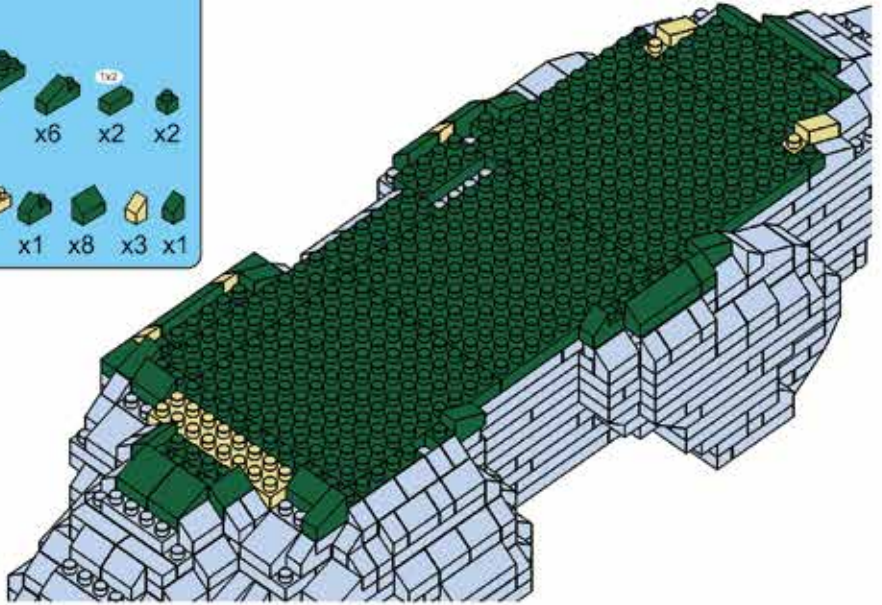

27

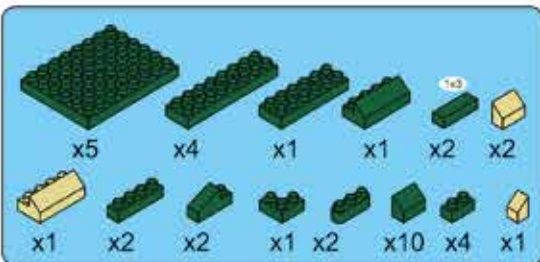
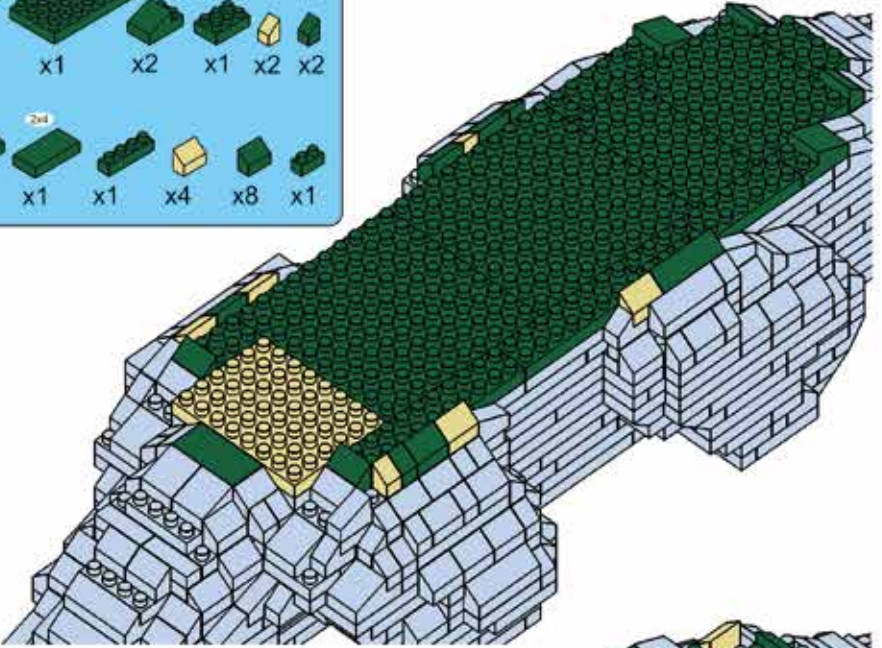

28

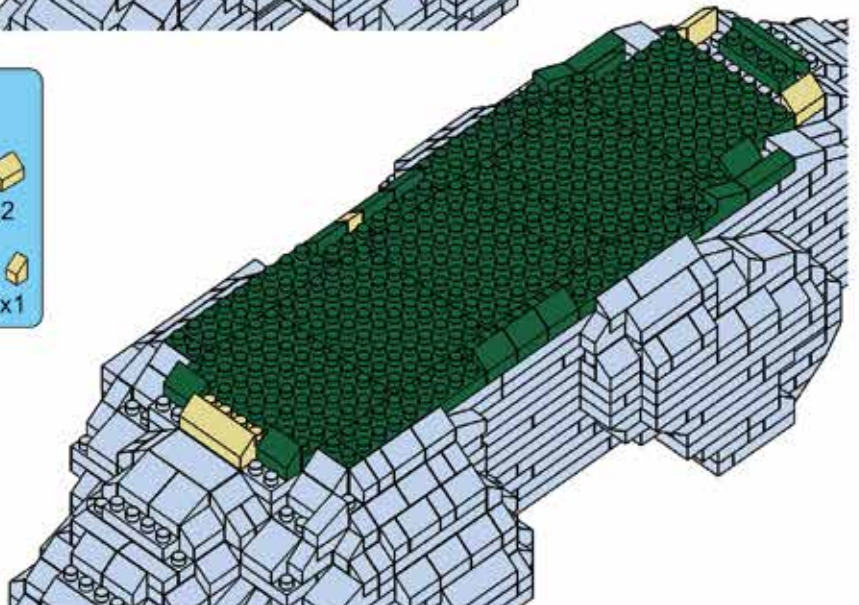

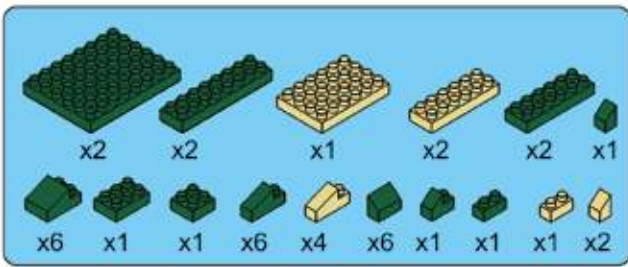

29

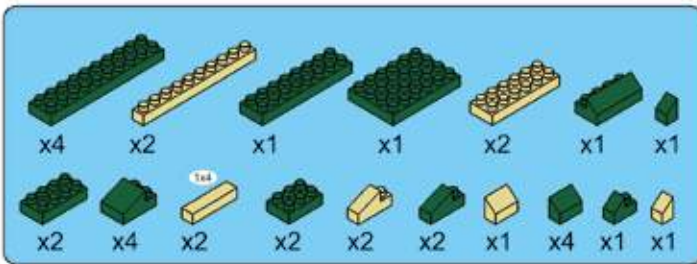
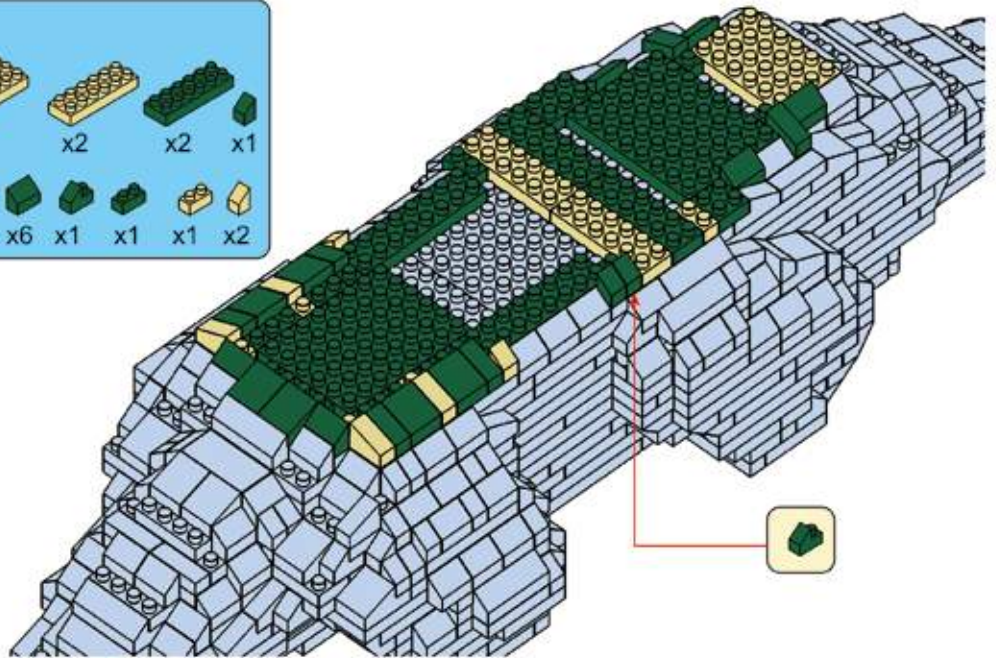

30

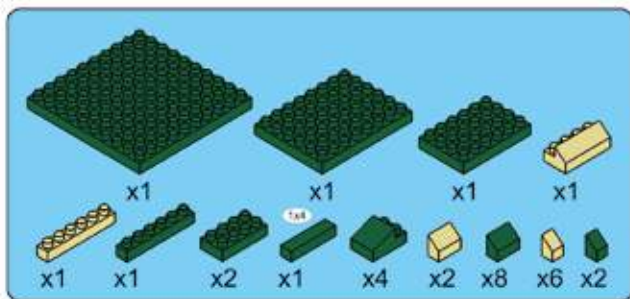
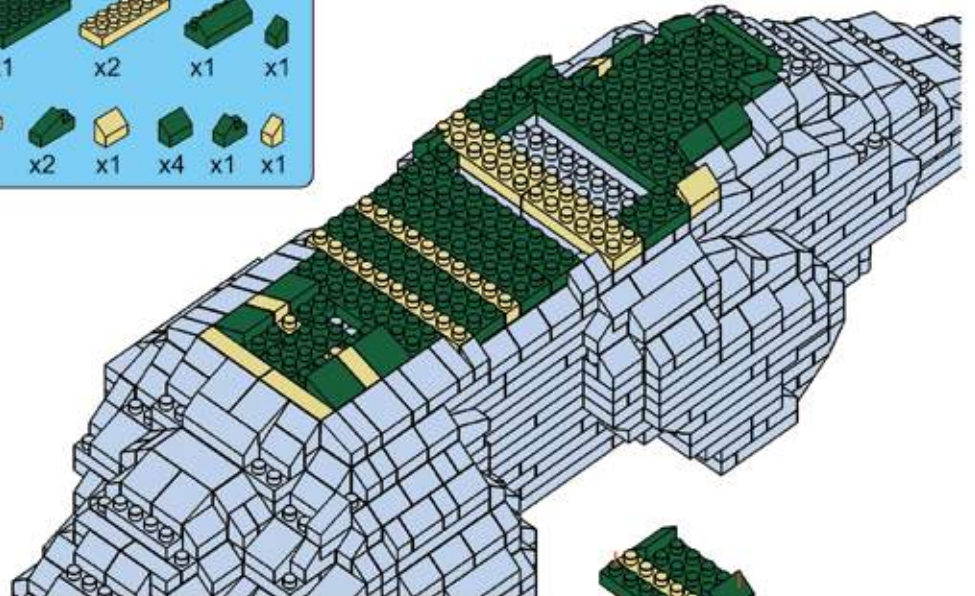

31

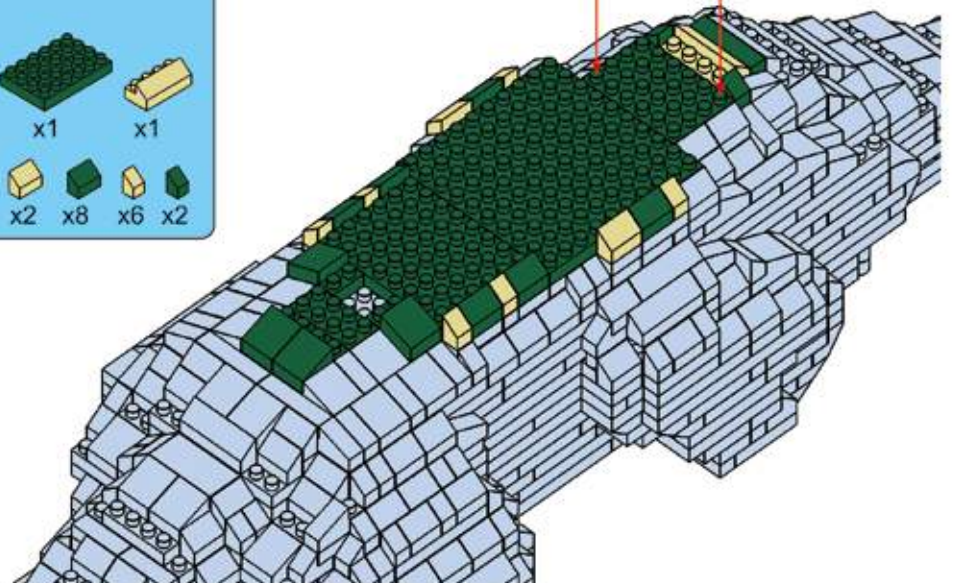

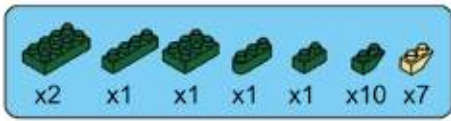

35

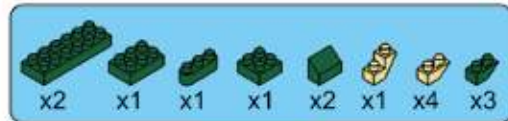
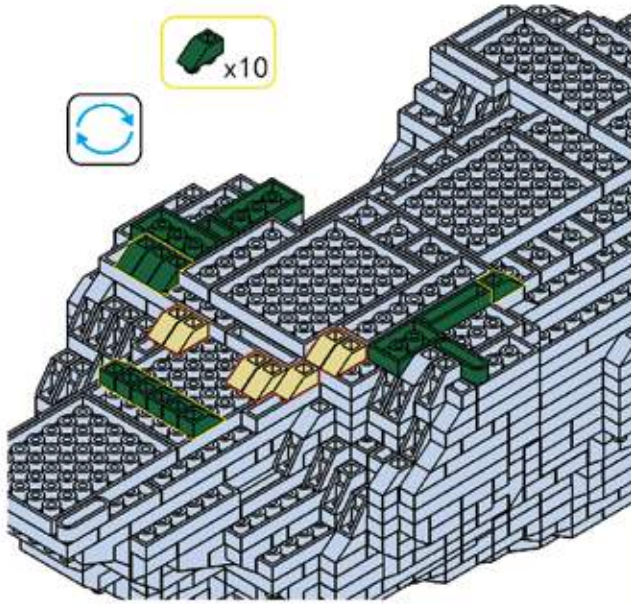

36

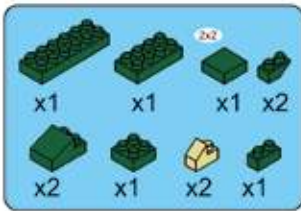
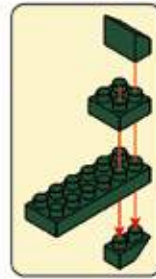
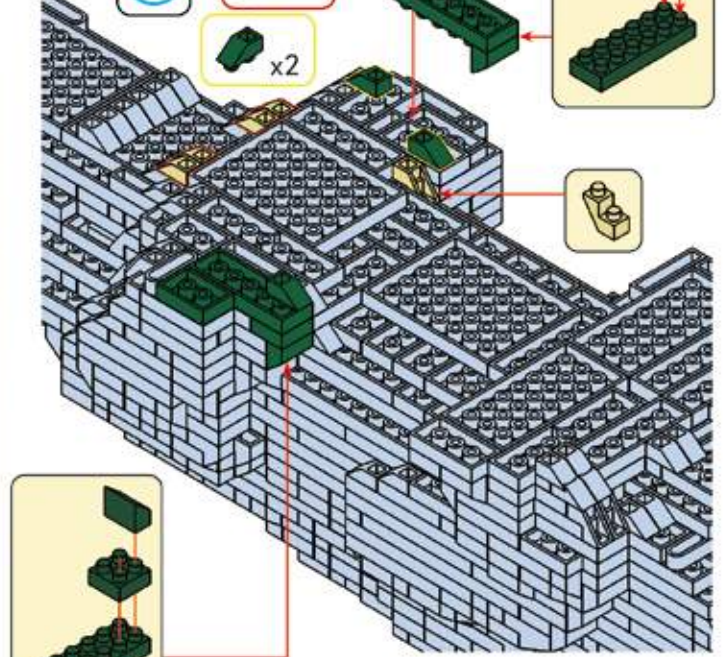
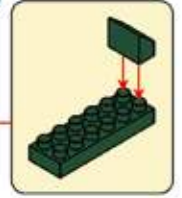

37

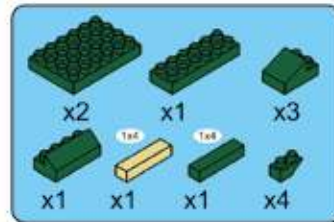
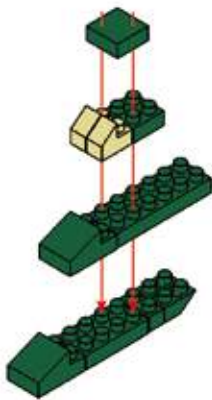

38

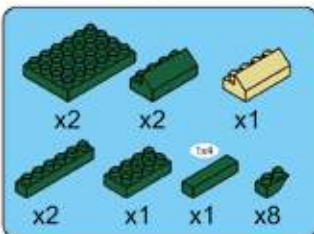
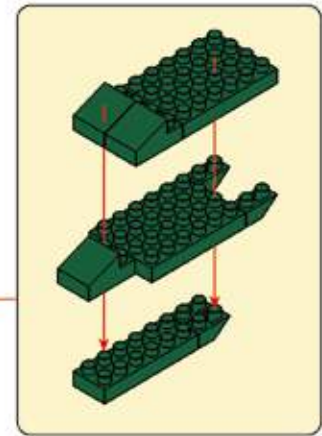
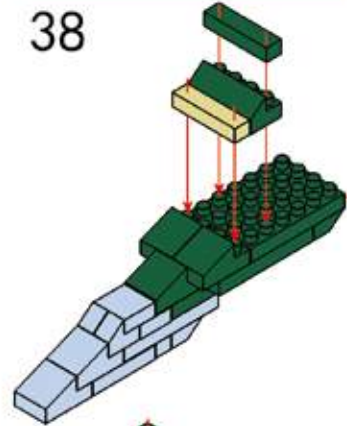

39

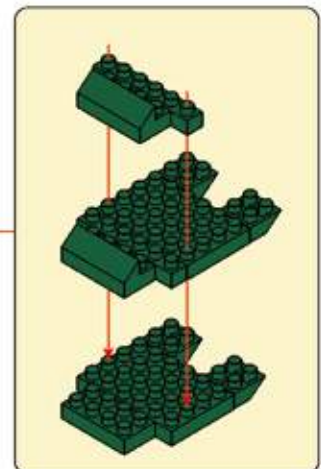
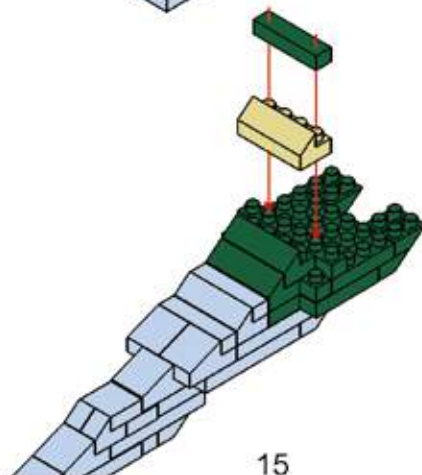

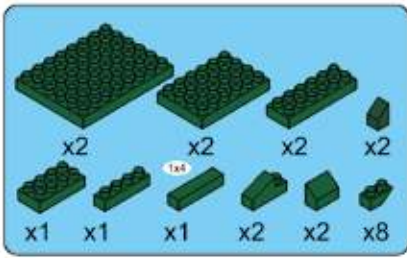

40

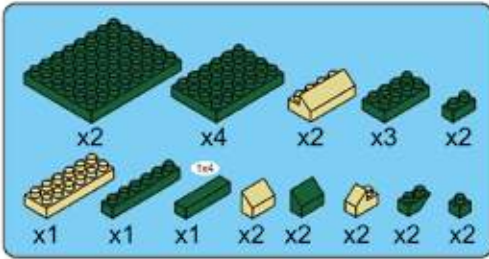
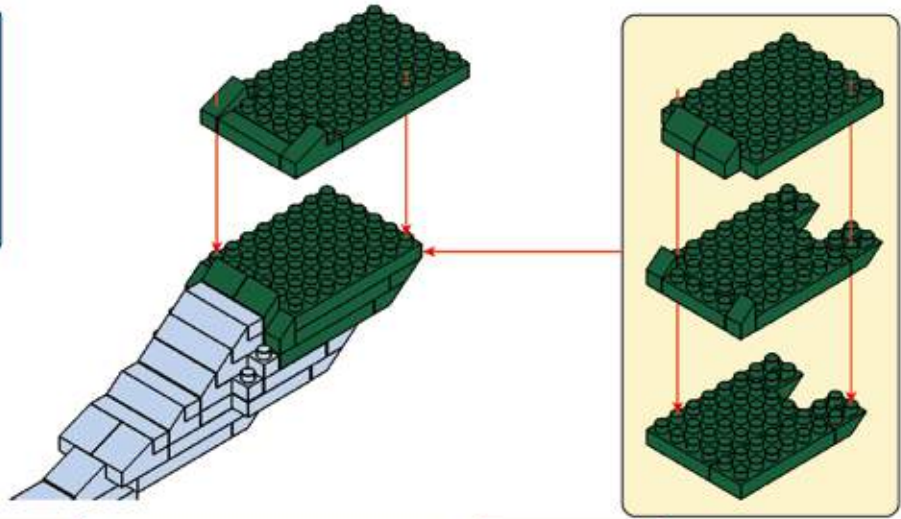

41

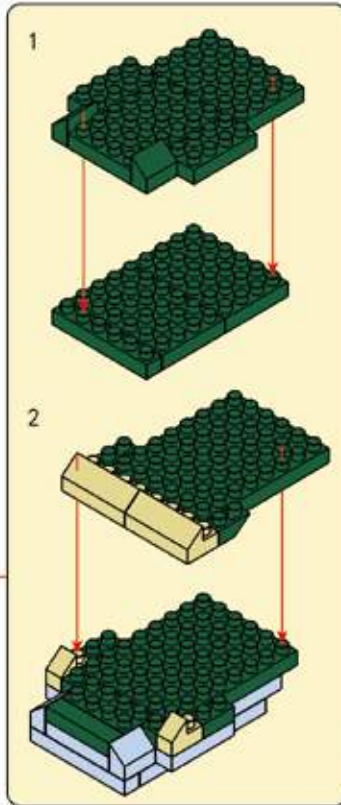
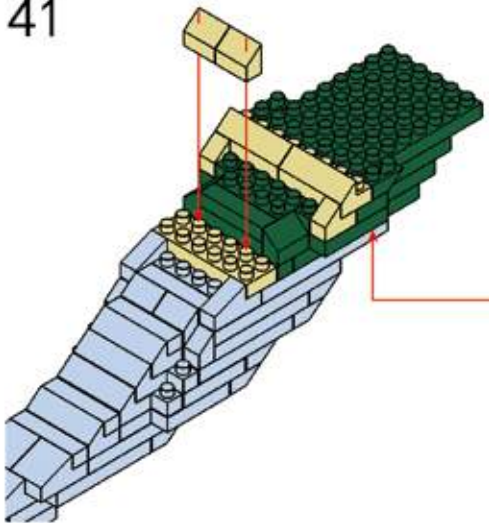

42

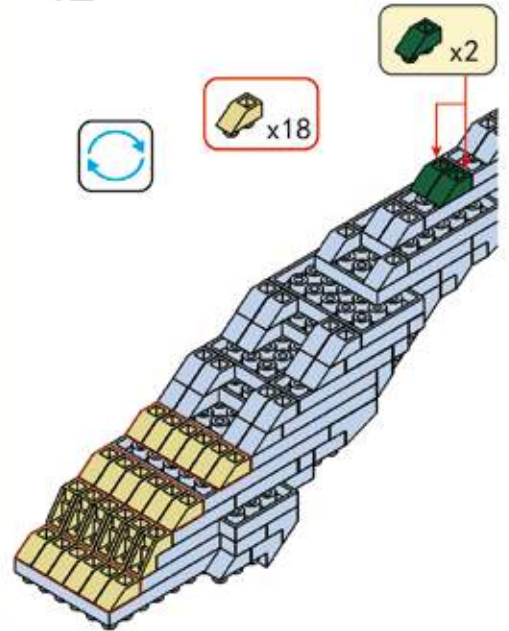

43

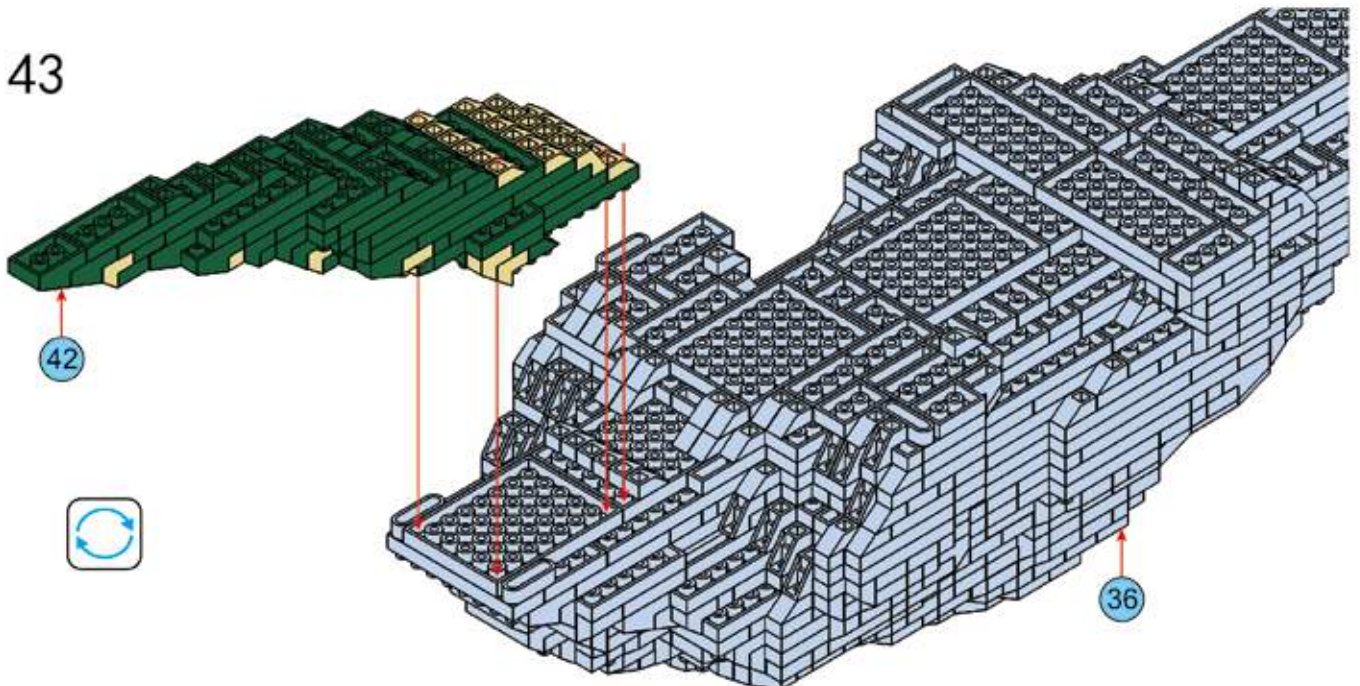

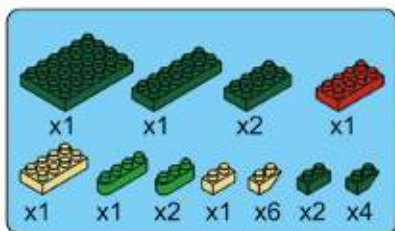

44

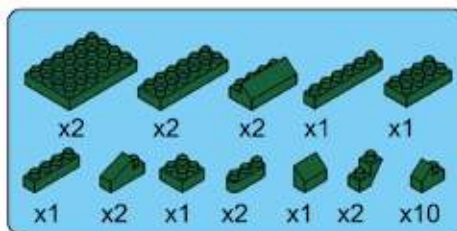
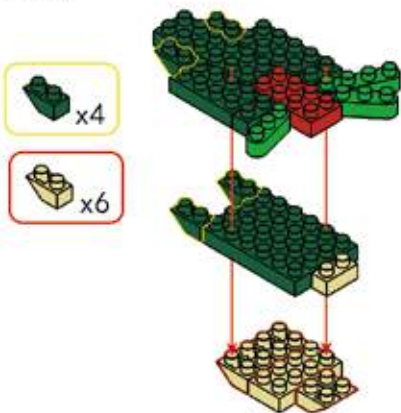

45

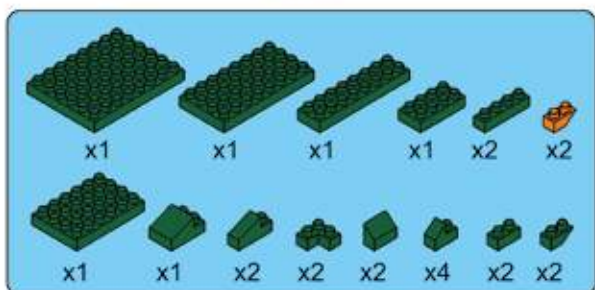
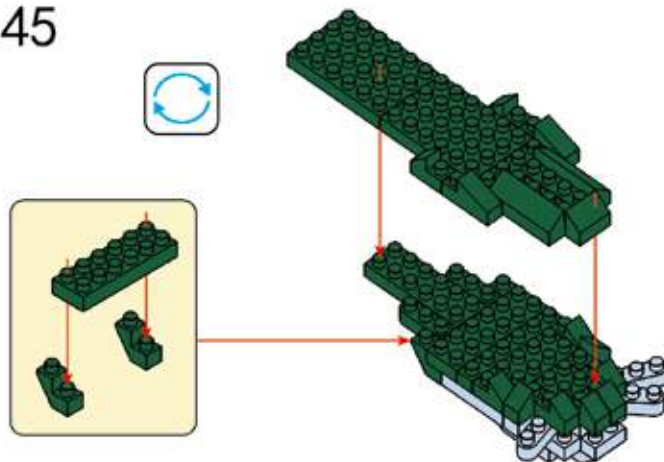

46

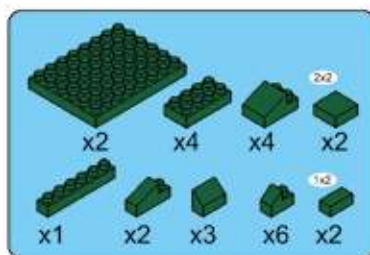
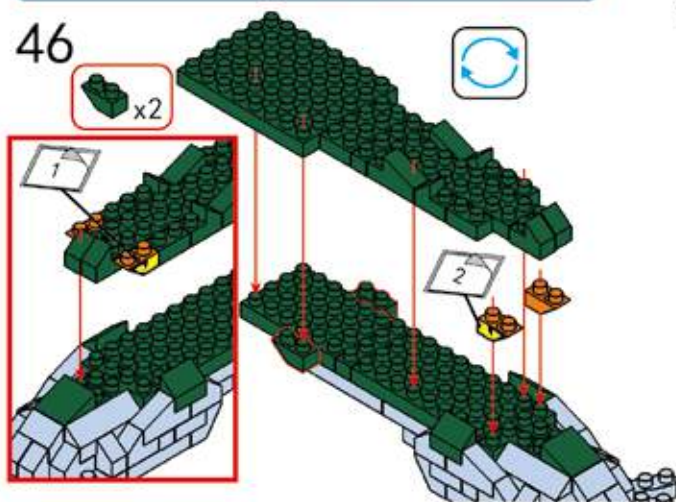

47

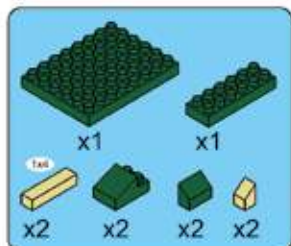
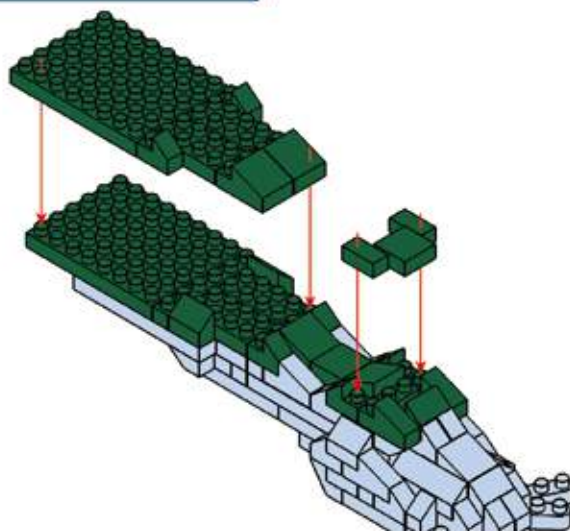

48

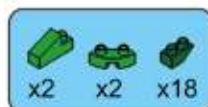
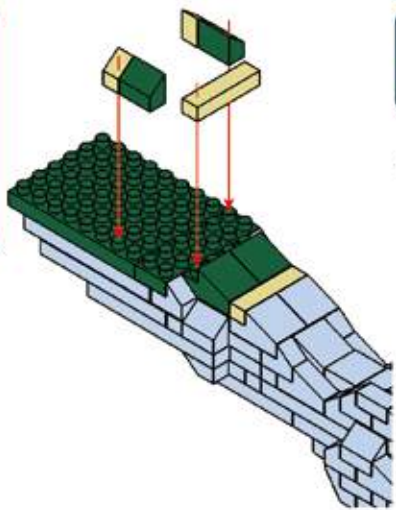

49

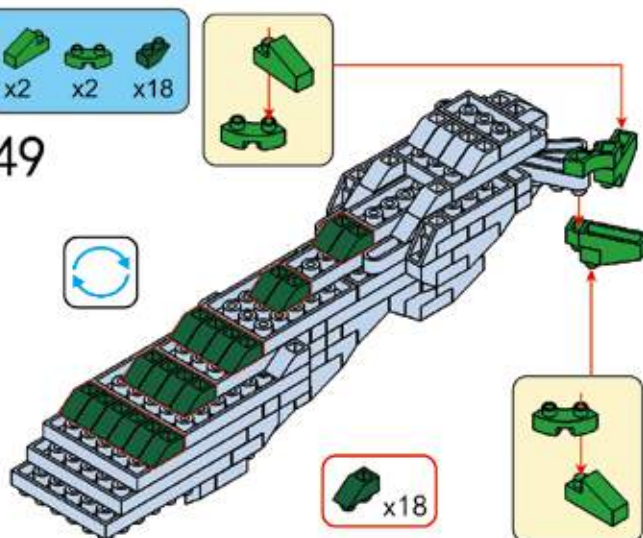

50

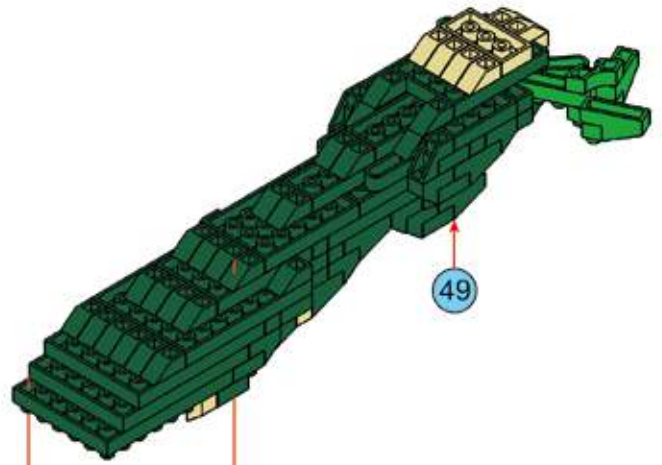

49

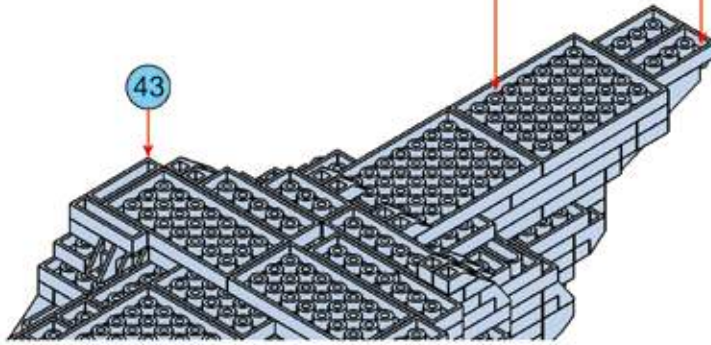

43

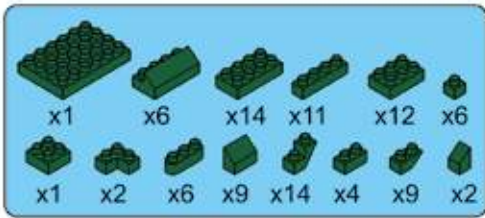

51

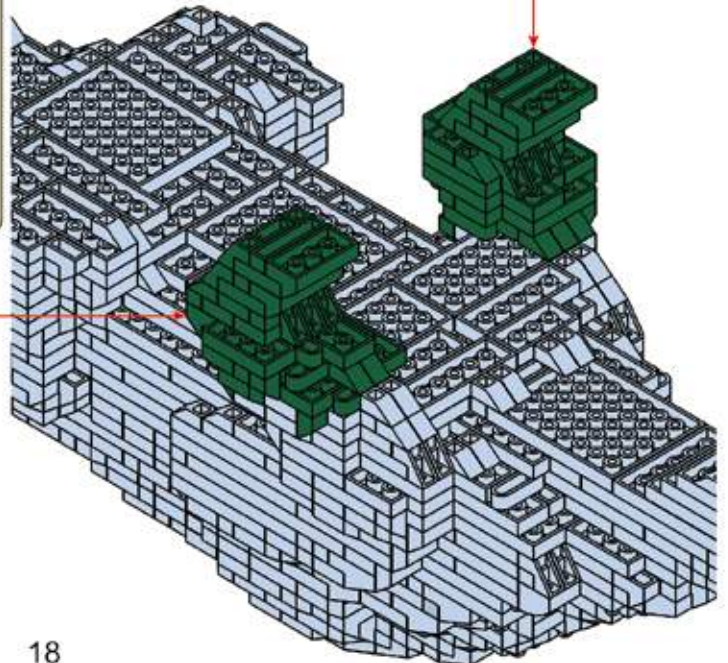
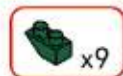
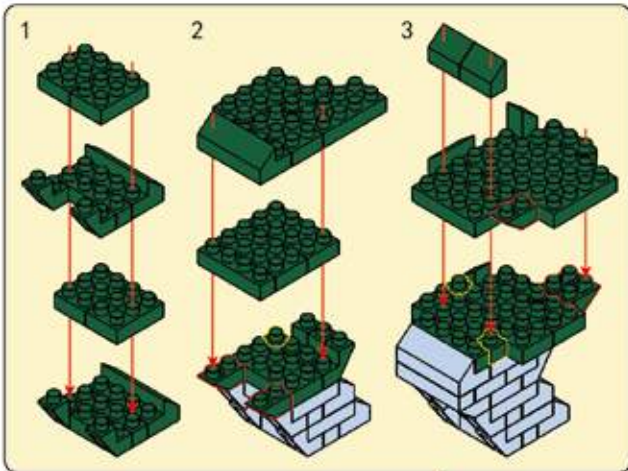
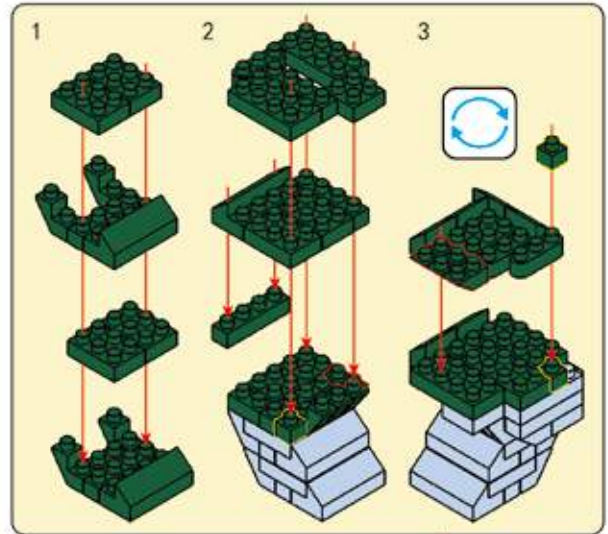

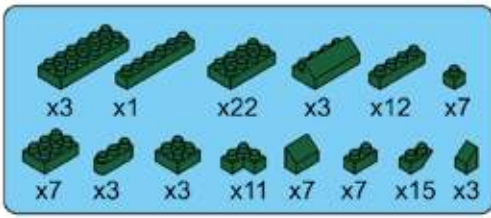

52

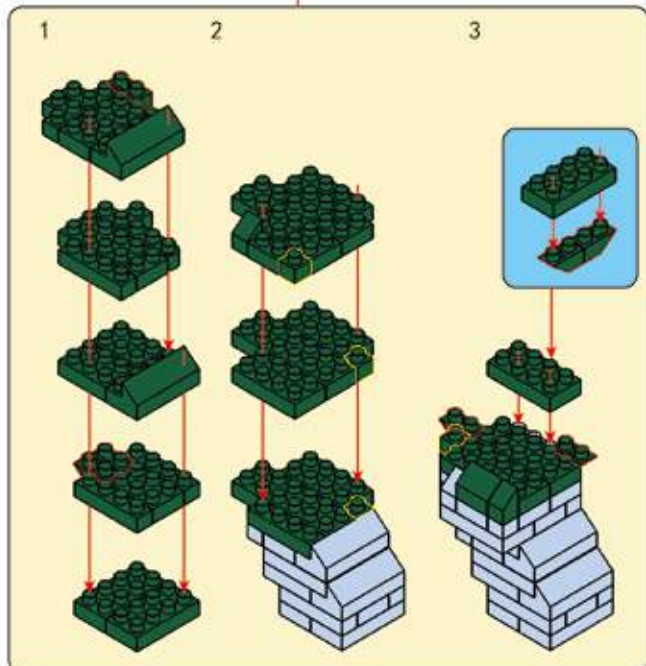
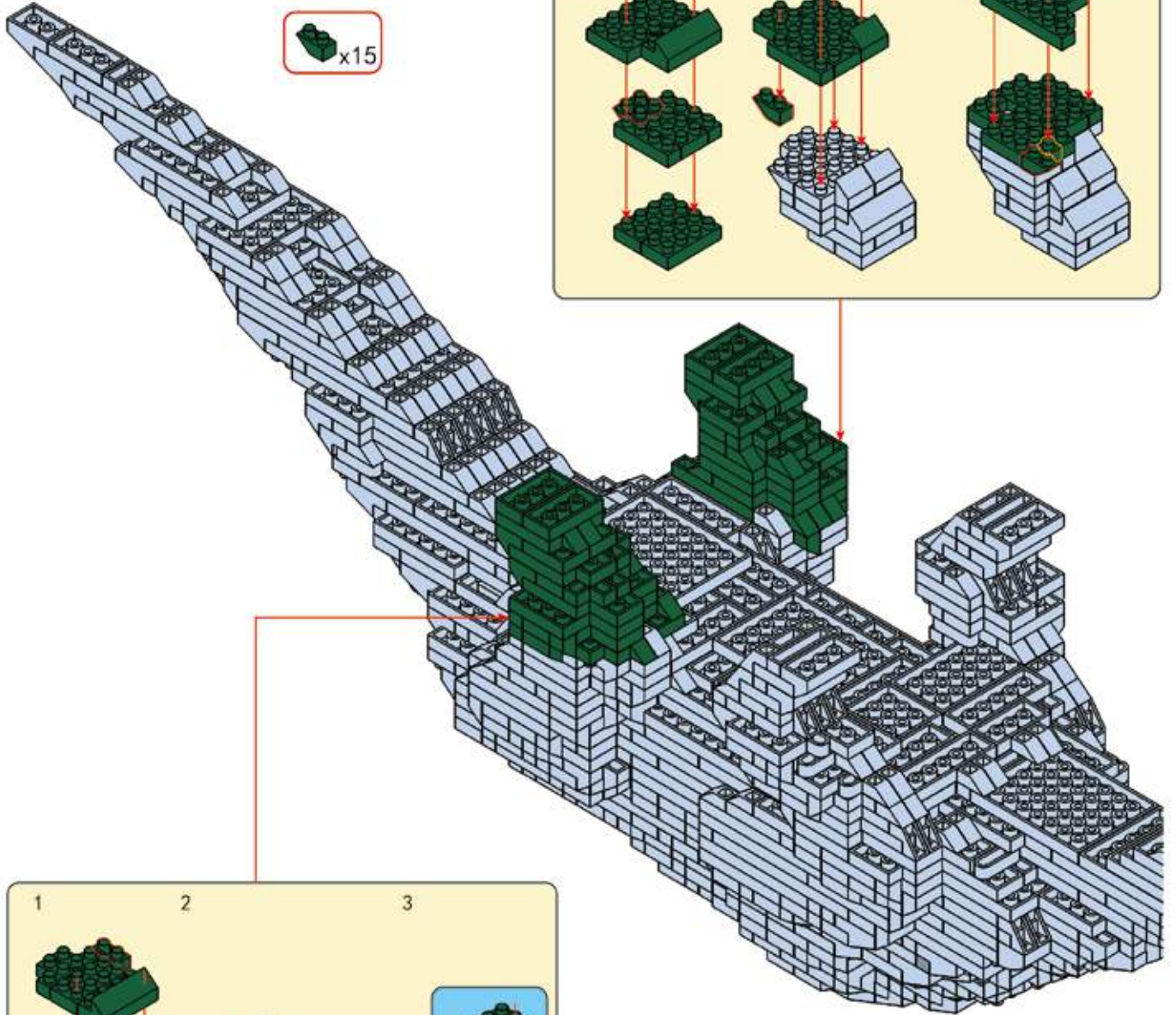
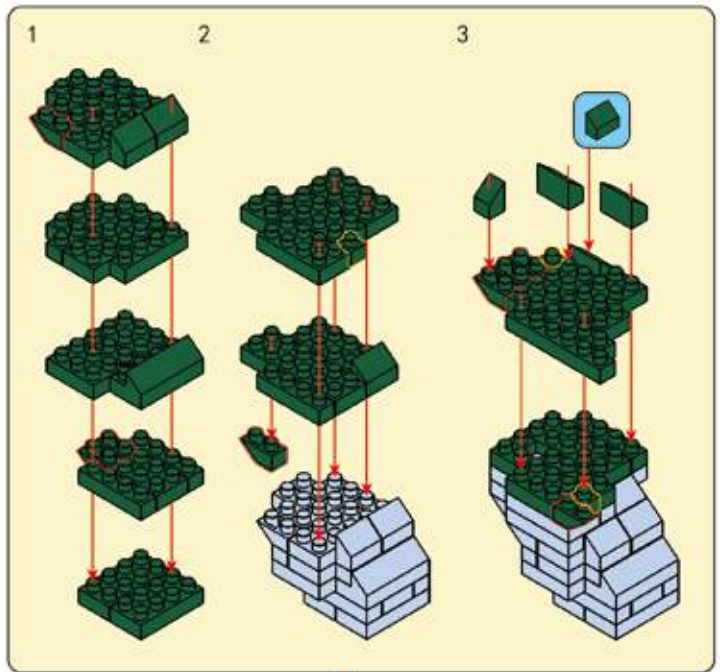

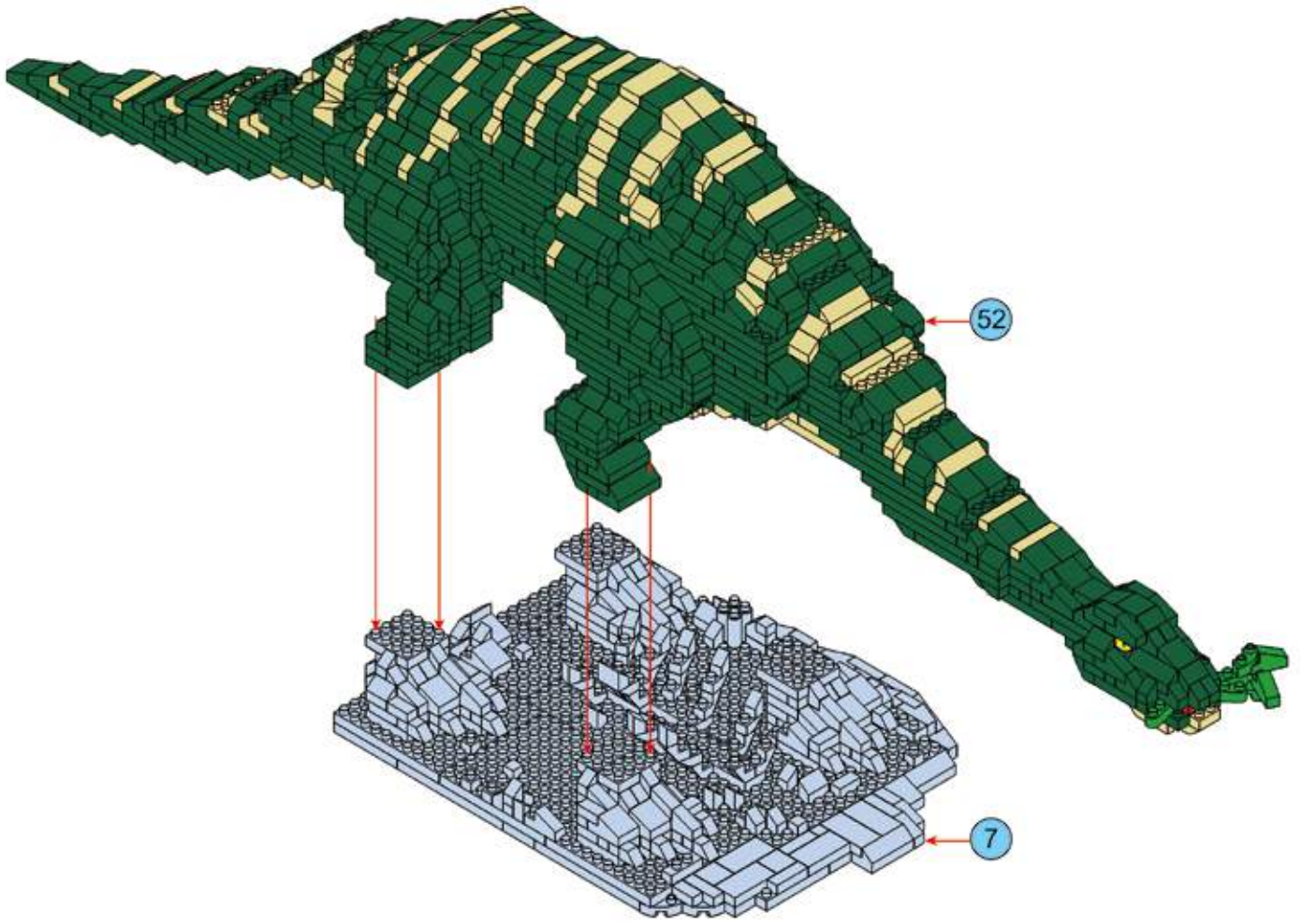

54

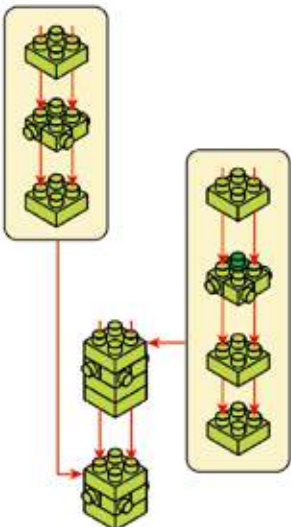

55

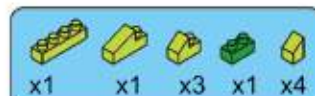
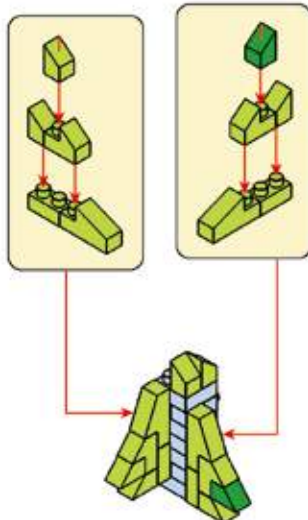

56

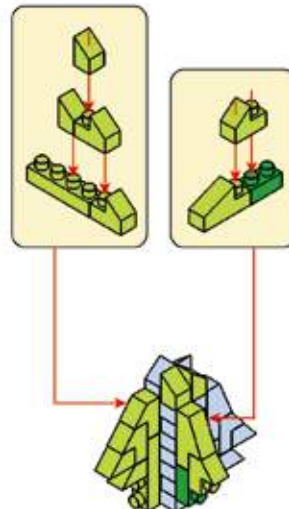

57

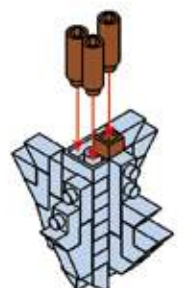

58

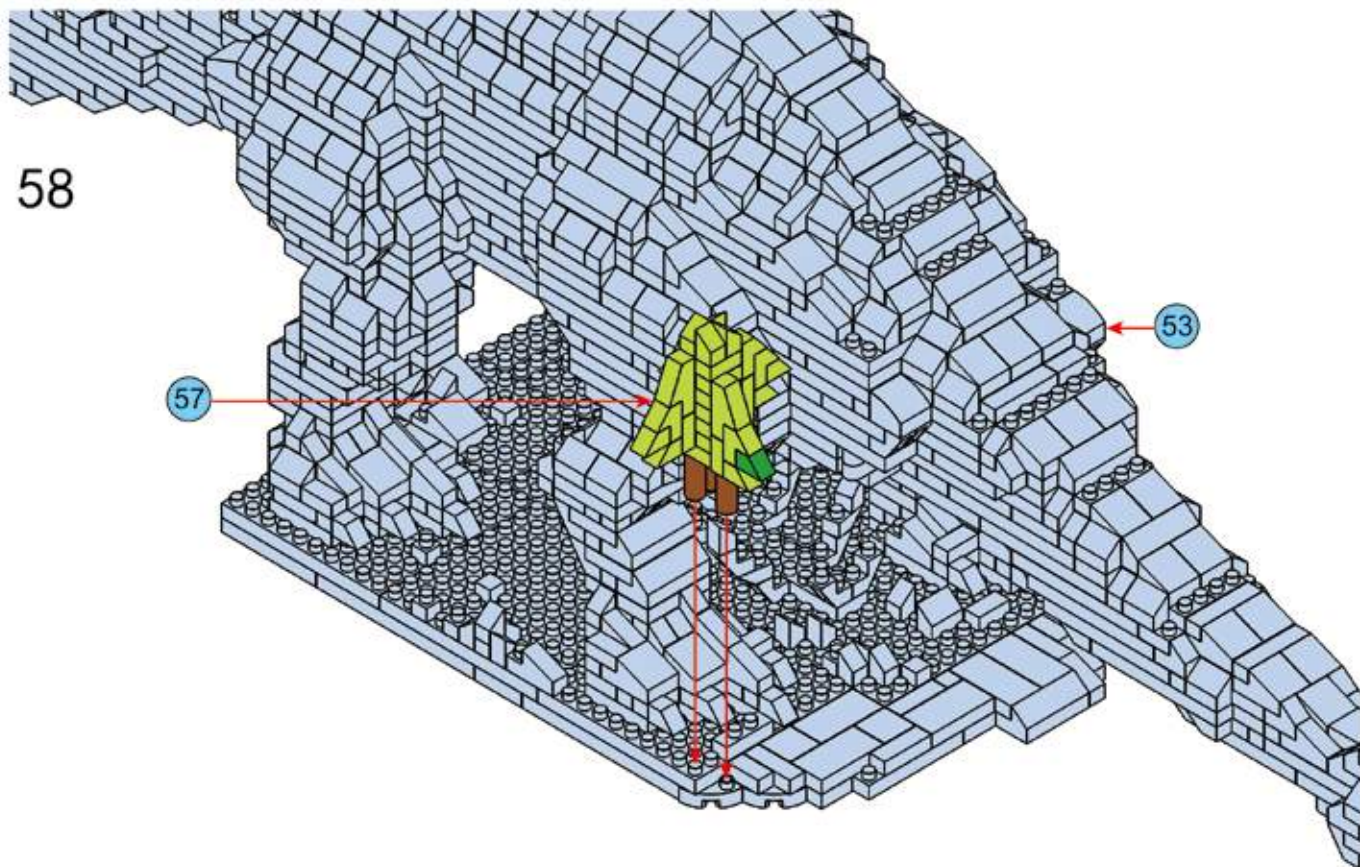

59

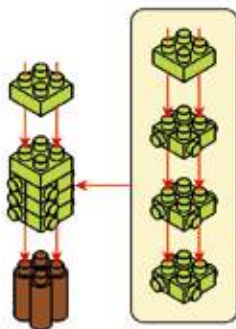

60

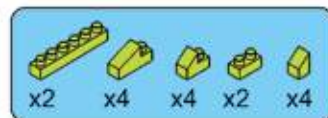
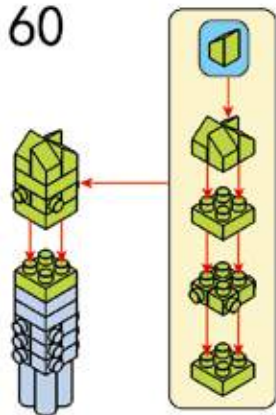

61

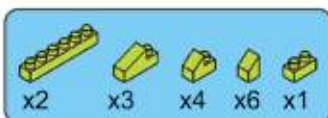
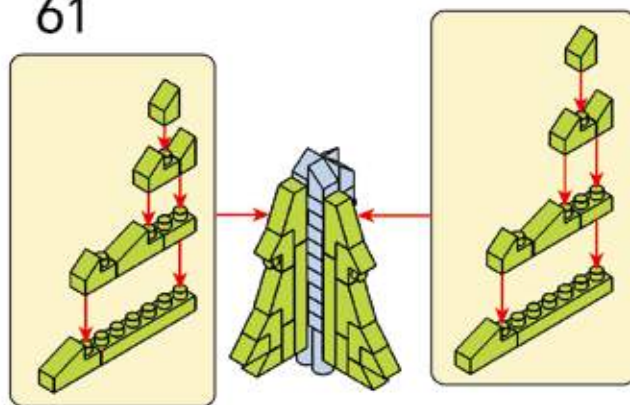

62

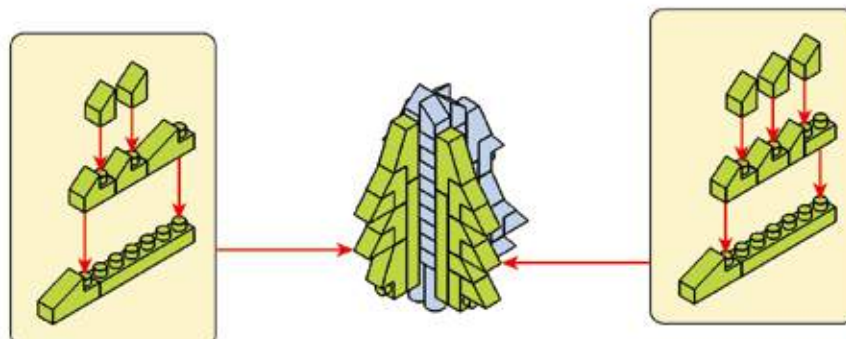

63

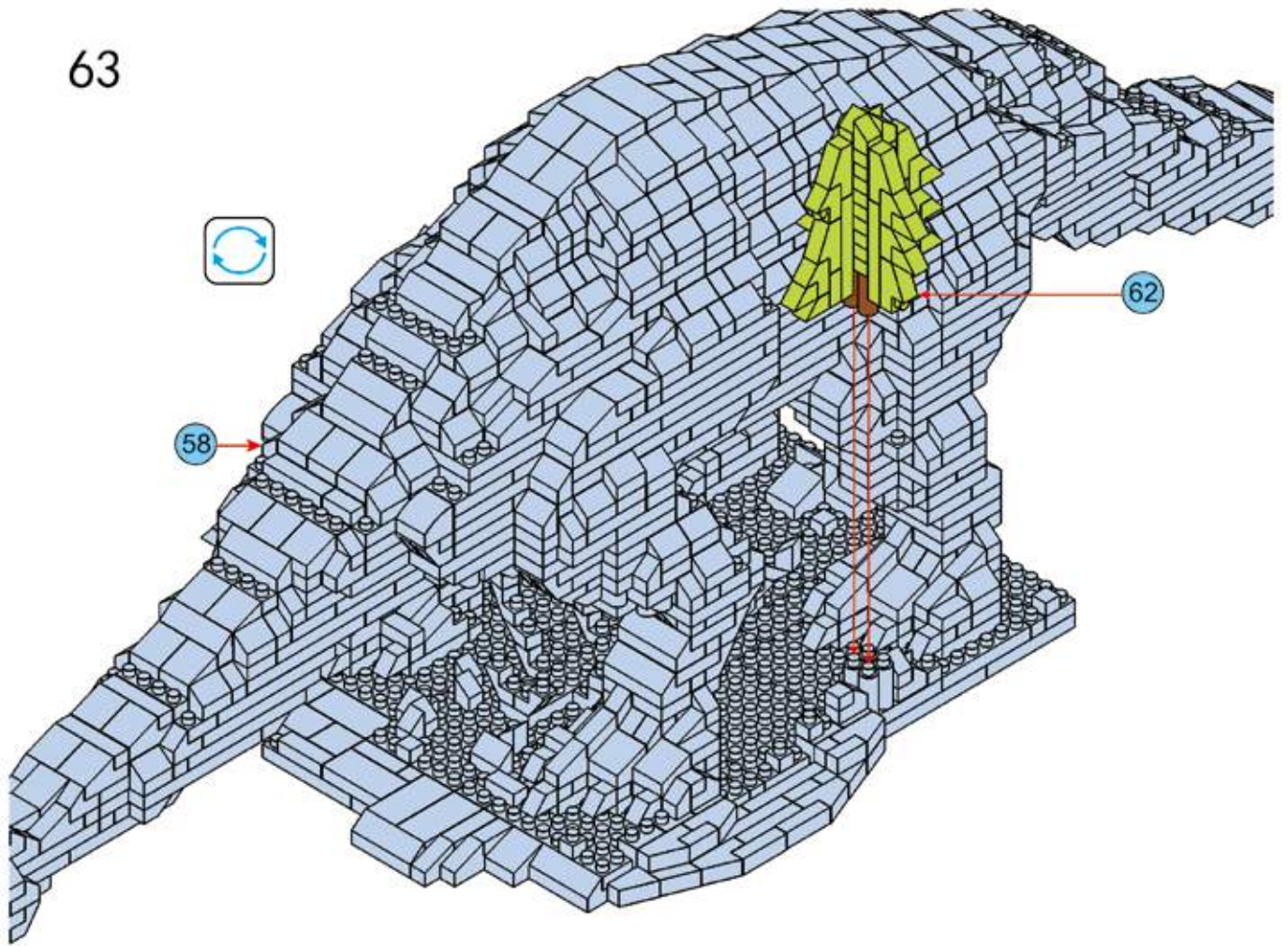

64



MINI BLOCK BRONTOSAURUS

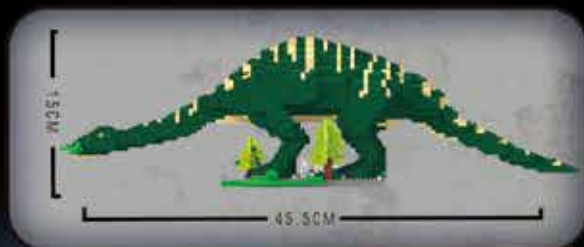

10+
YEARS

Difficulty index:



MINI BLOCK TRICERATOPS



10+
YEARS

1996 PCS

Difficulty index:



MINI BLCOK TRICERATOPS

keycode:43341016
ADULT ASSISTANCE IS RECOMMENDED.
PRODUCT MAY SLIGHTLY FROM IMAGE SHOWN.

 **WARNING:**
CHOKING HAZARD - SMALL PARTS
NOT FOR CHILDREN UNDER 3 YEARS.

10+
YEARS

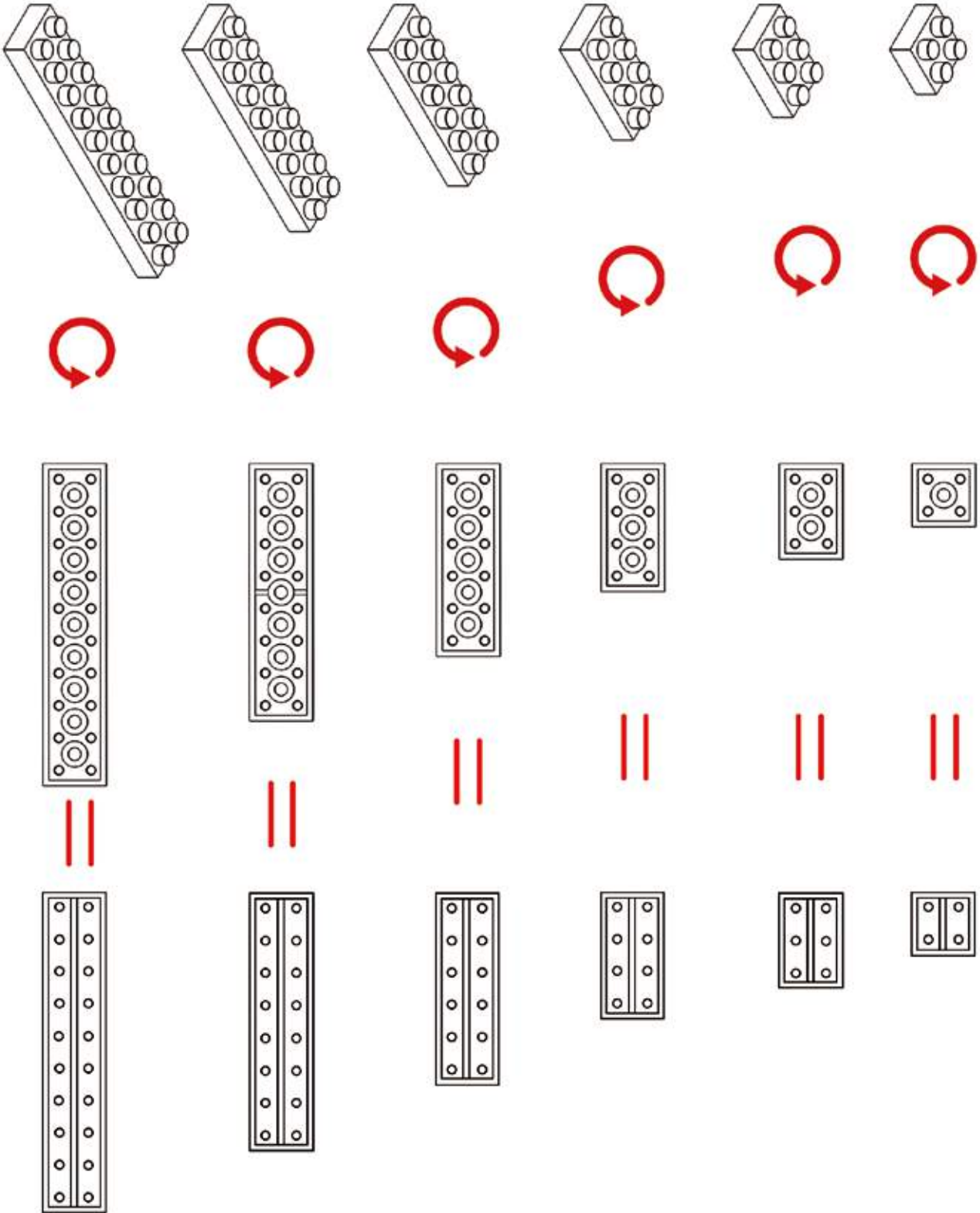

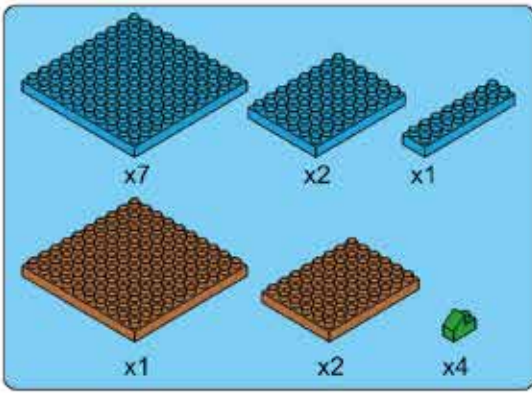

1

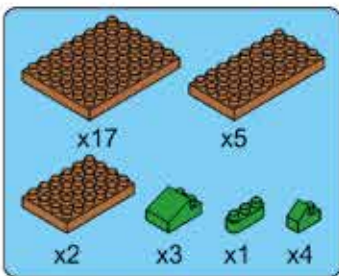
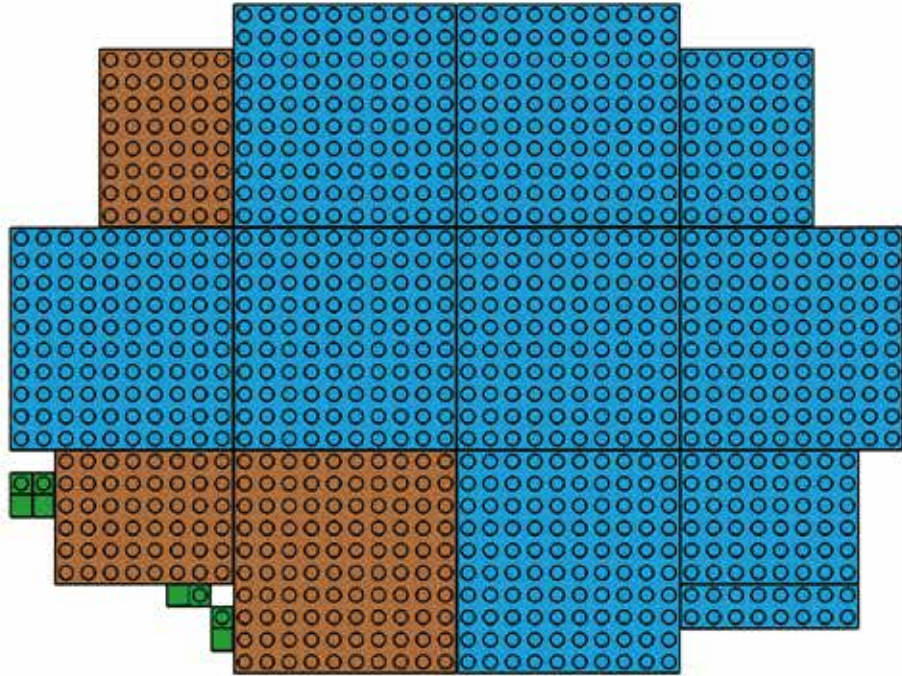

2

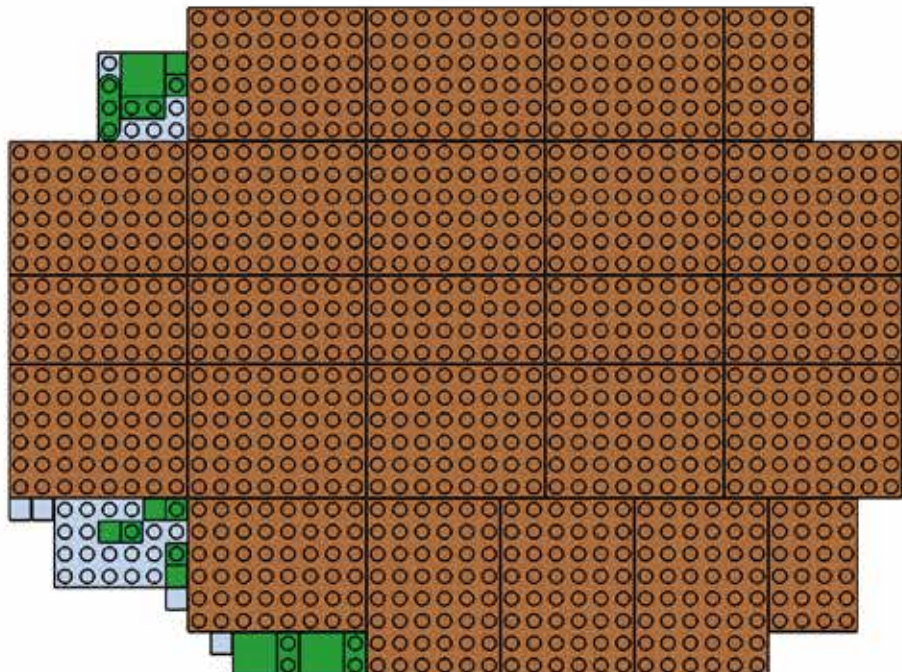

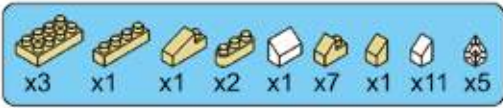

5

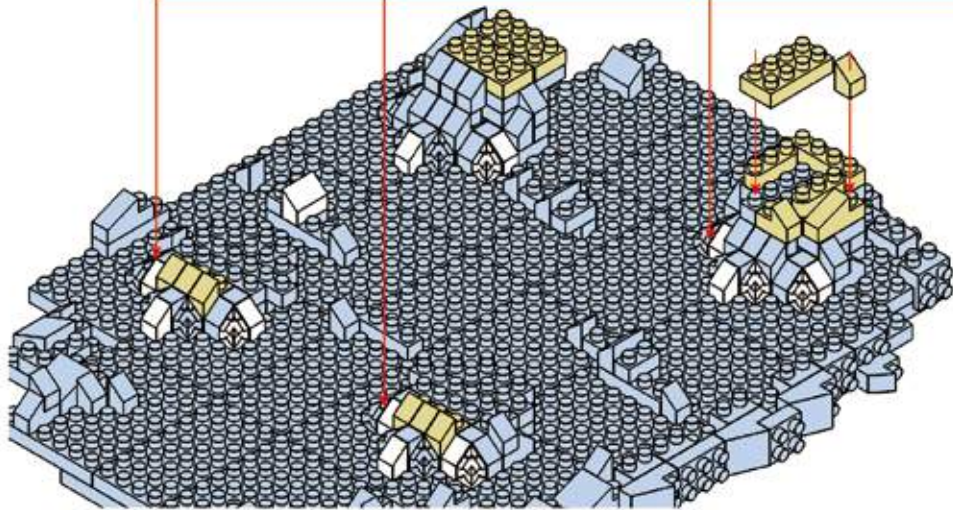

6

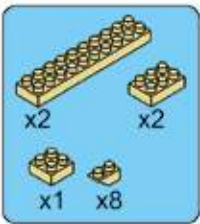
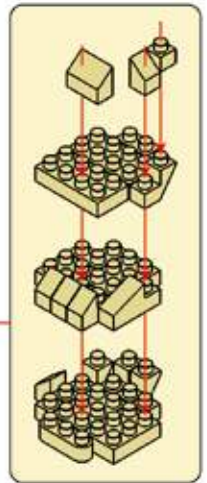
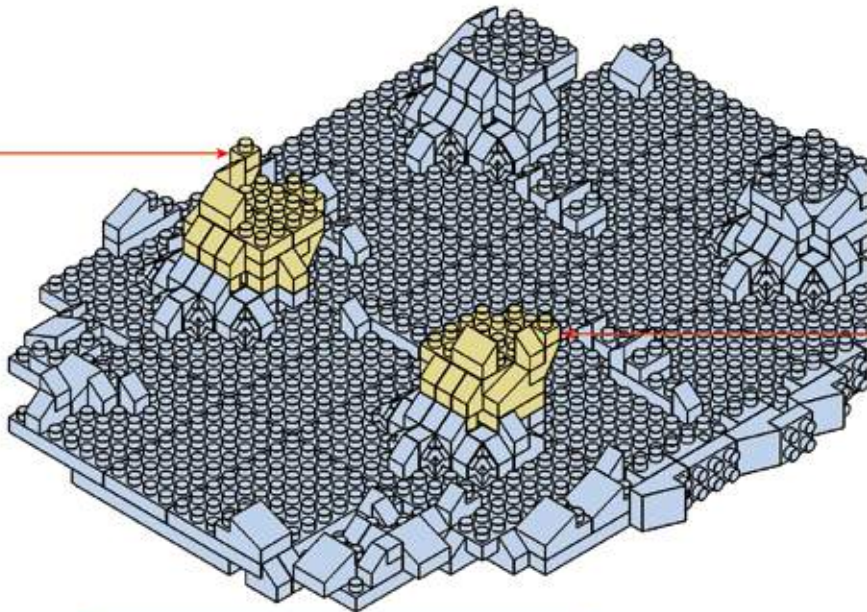
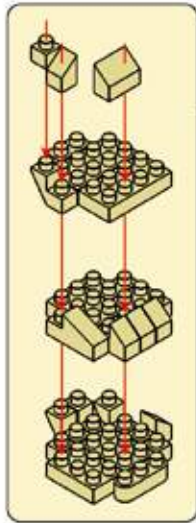

7

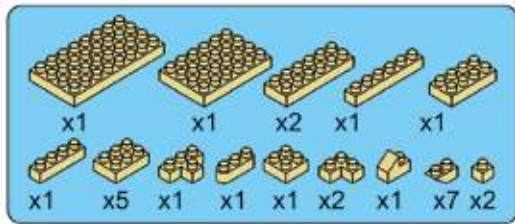
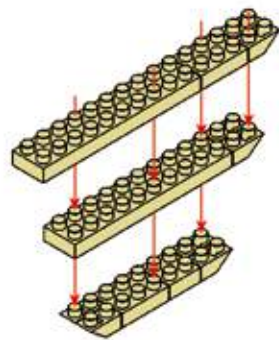

8

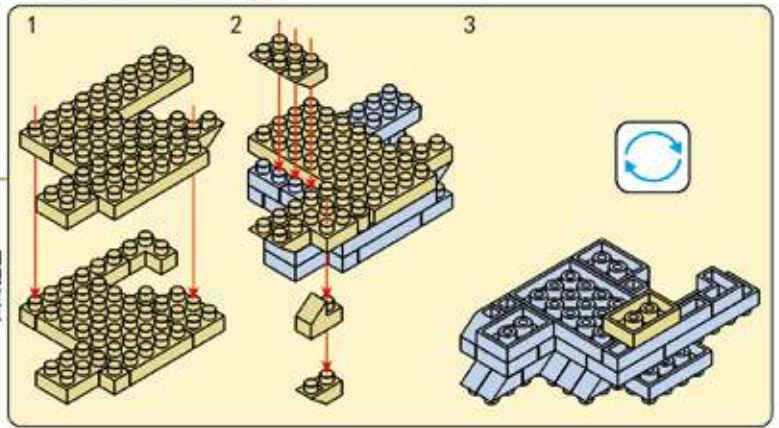
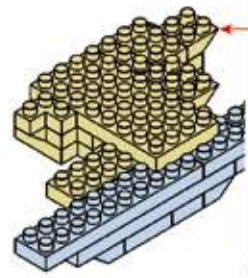

3

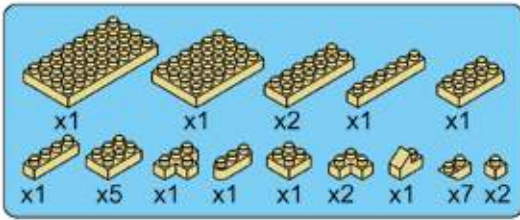

9

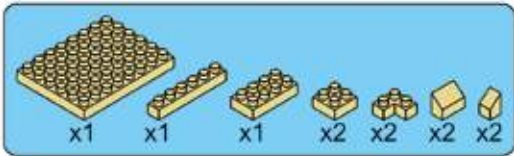
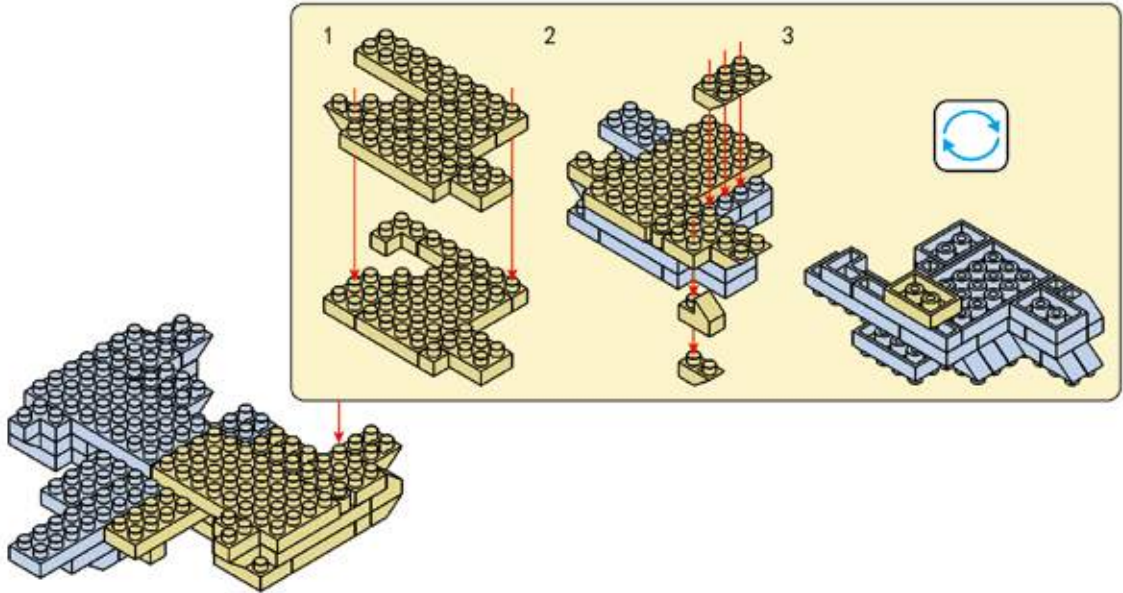

10

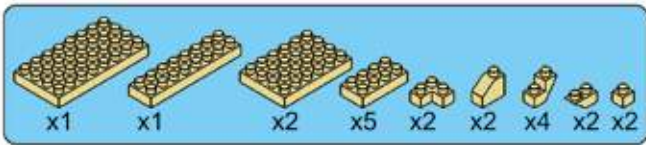
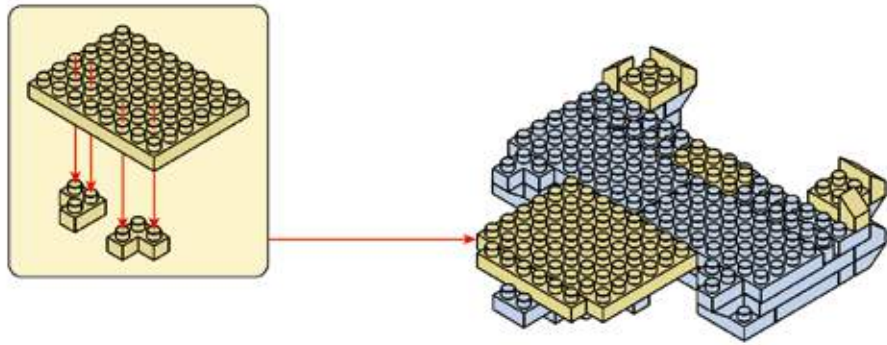

11

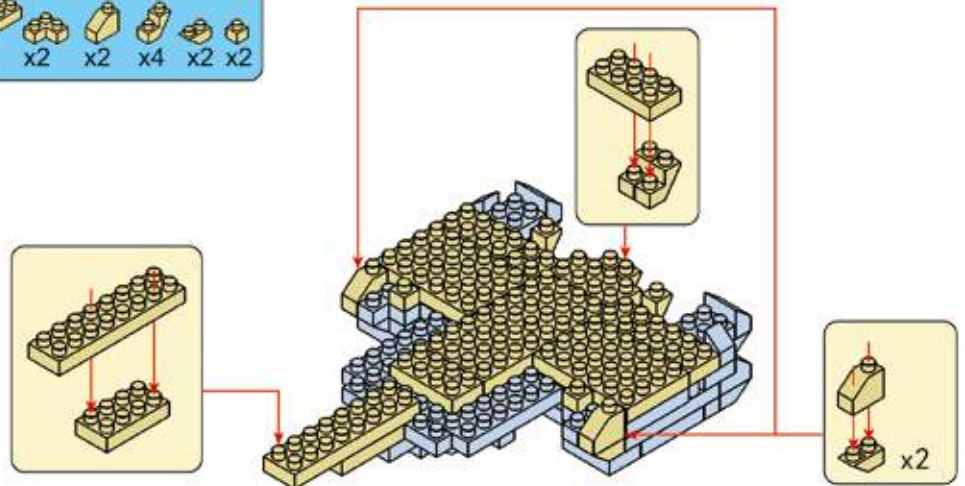

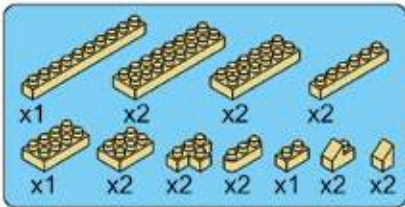

12

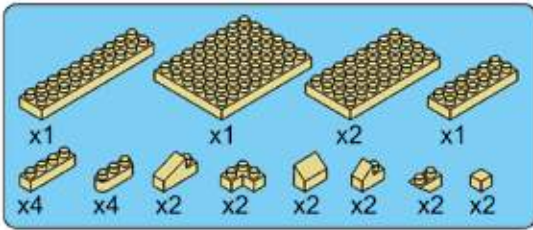
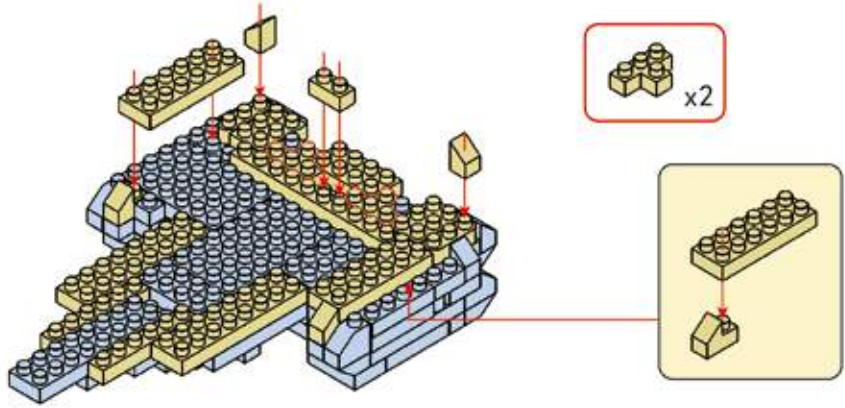

13

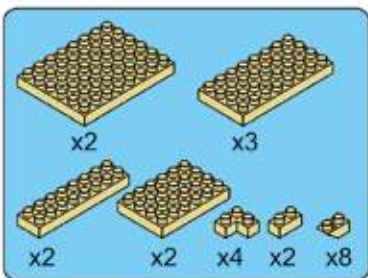
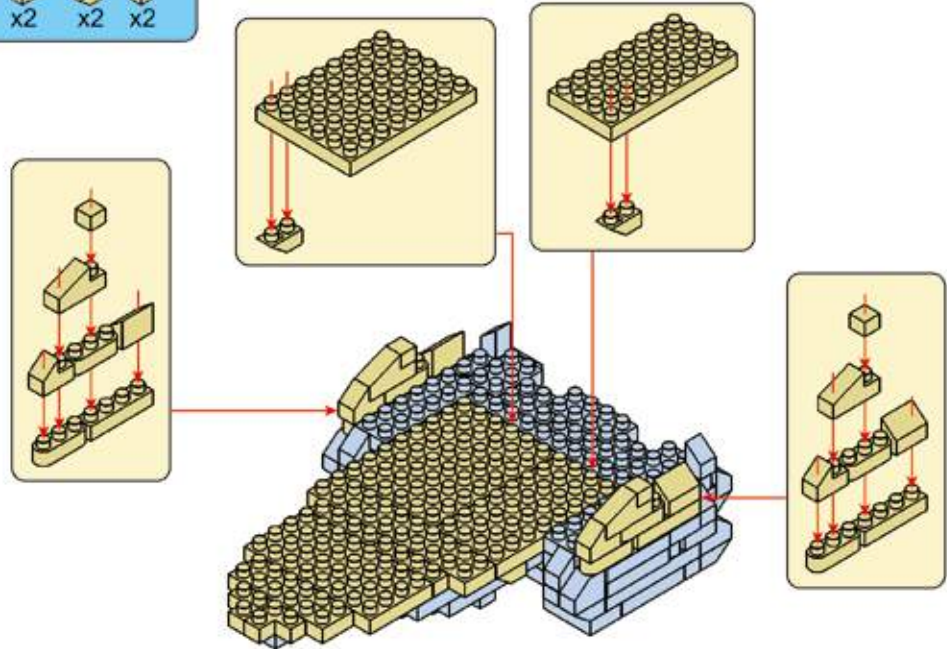

14

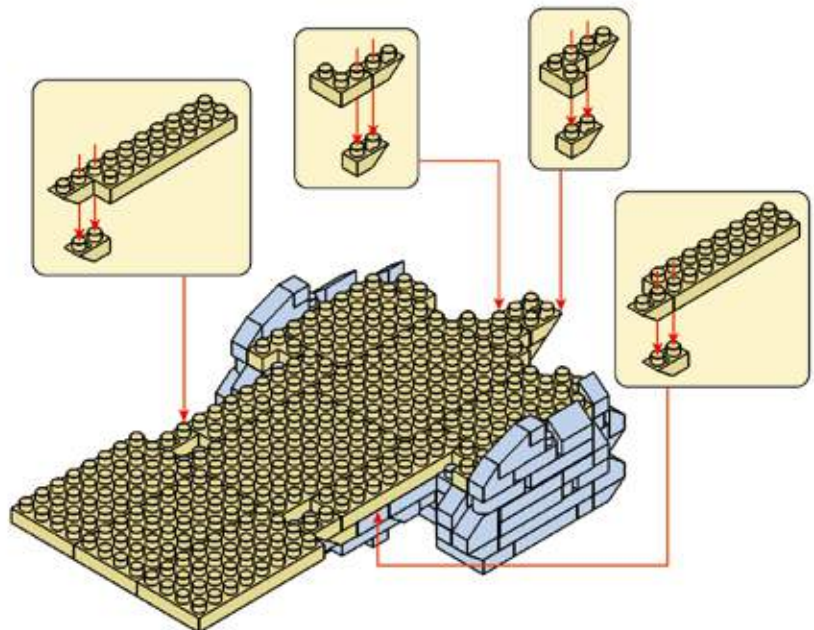

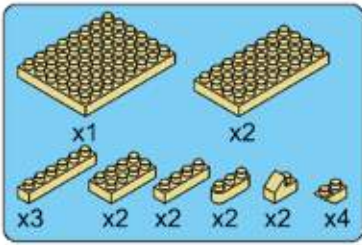

15

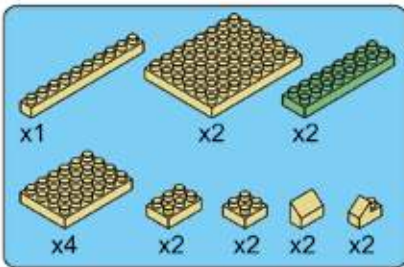
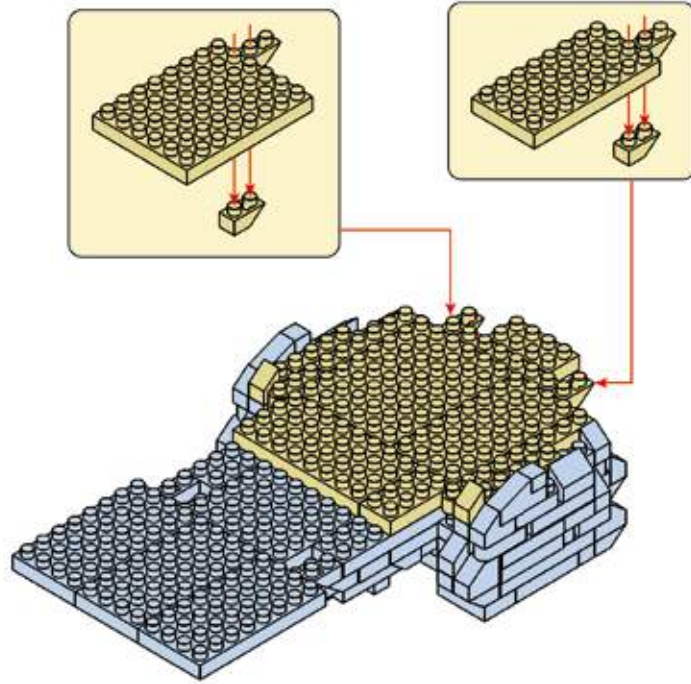

16

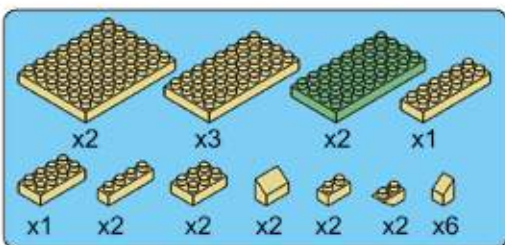
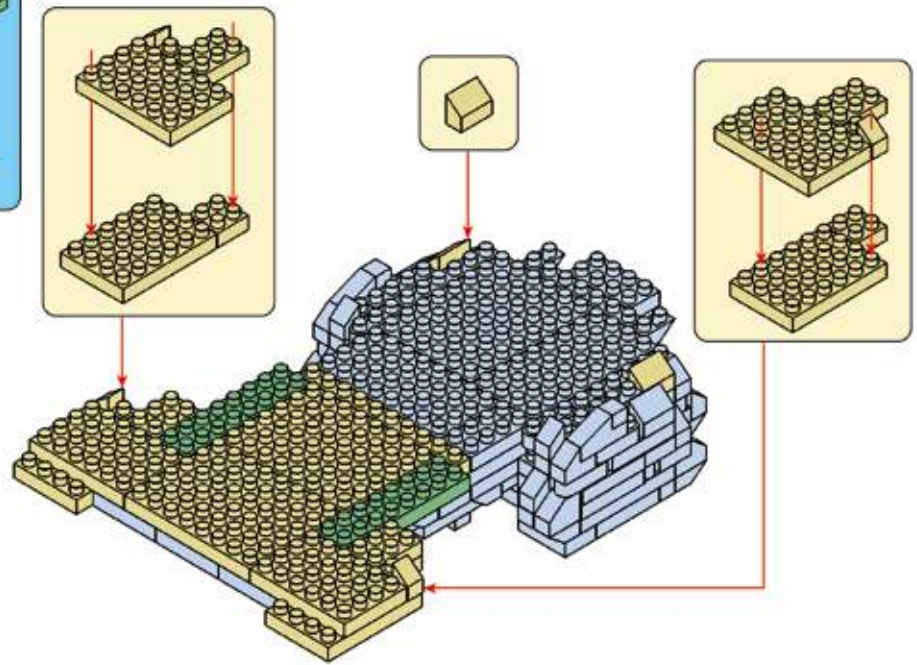

17

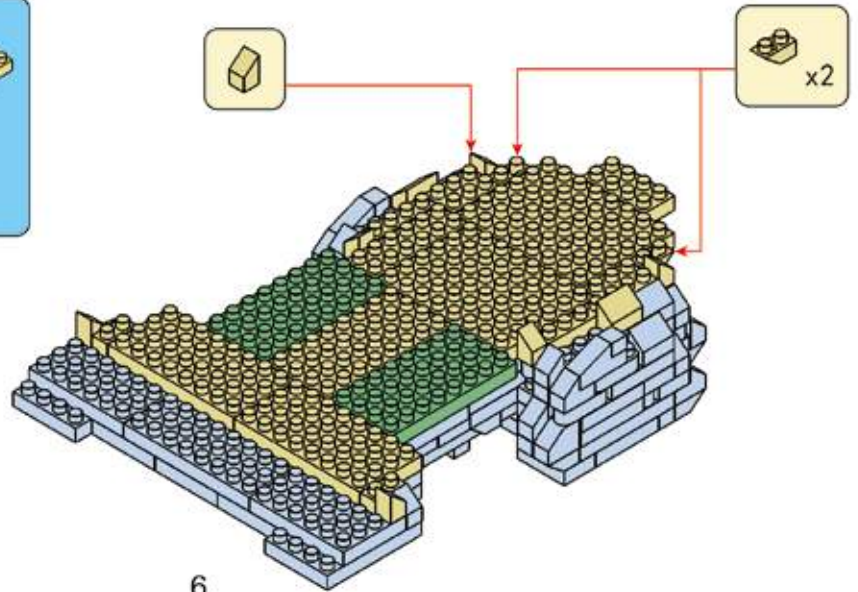

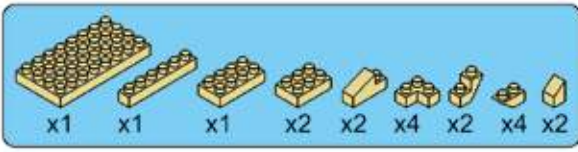

18

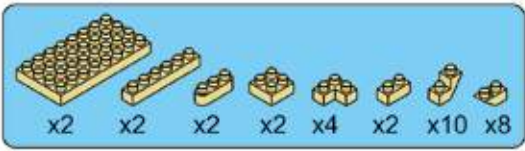
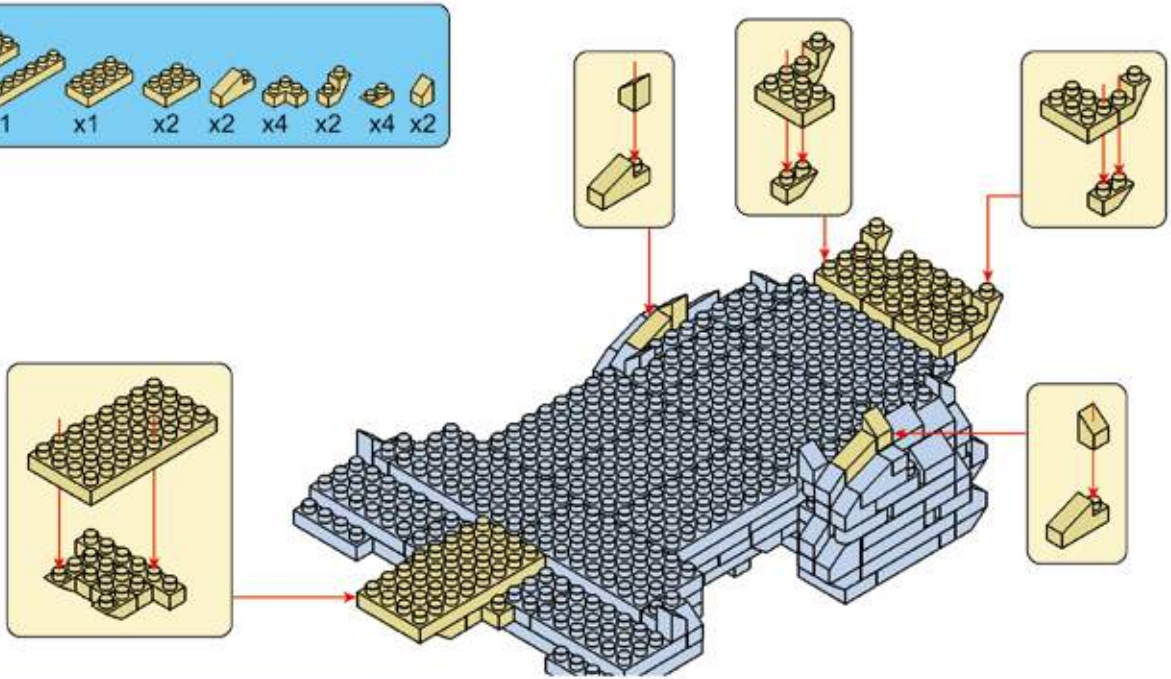

19

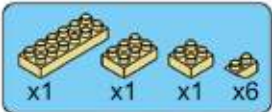
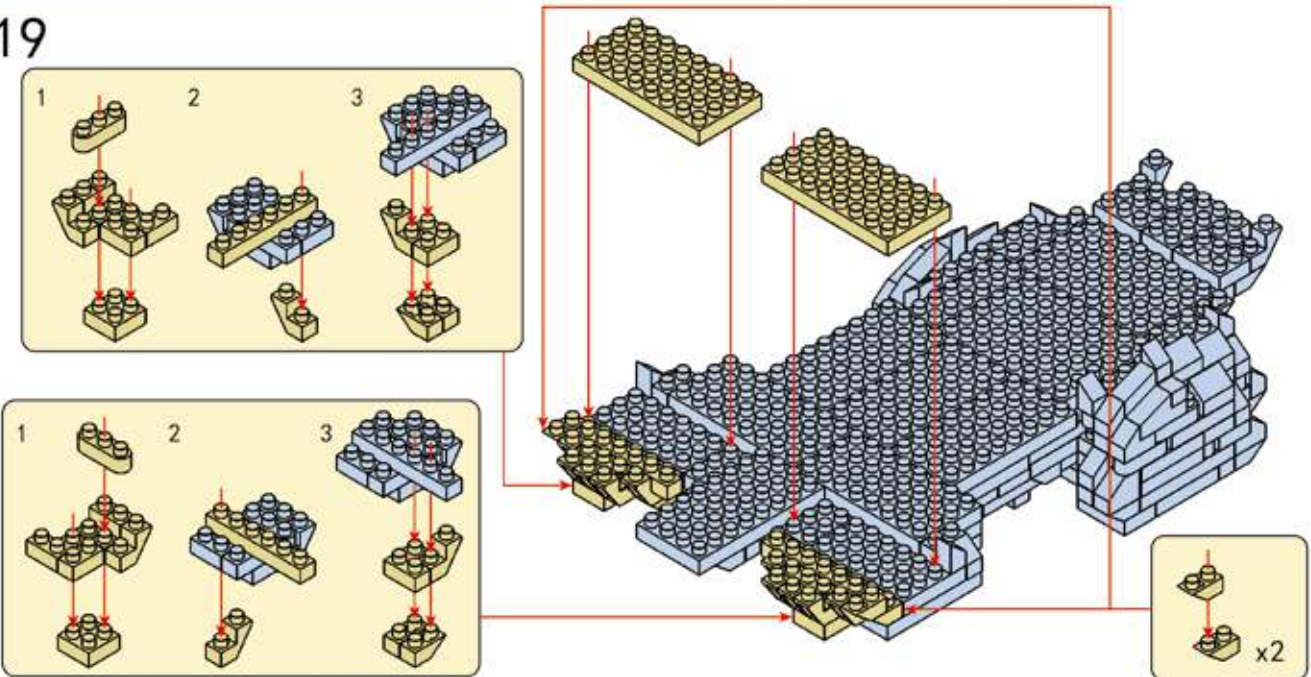

20

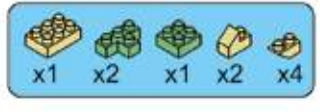
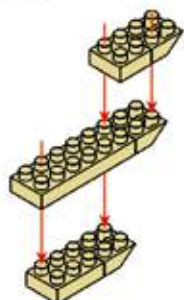

21

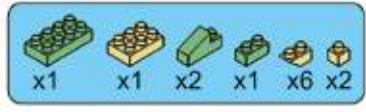
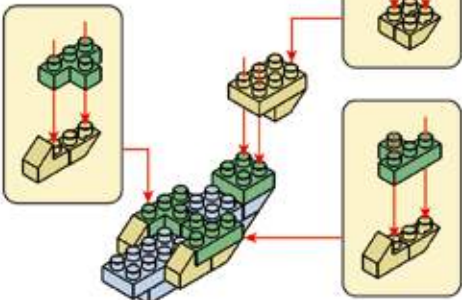

22

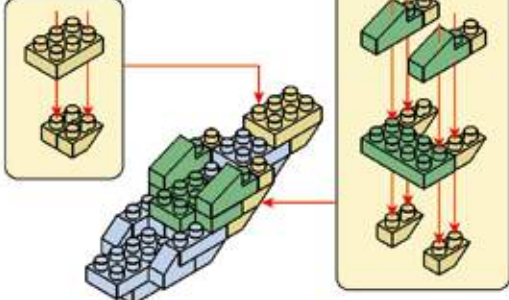



23

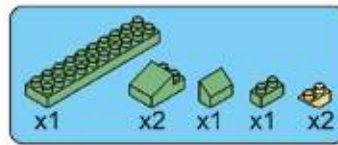
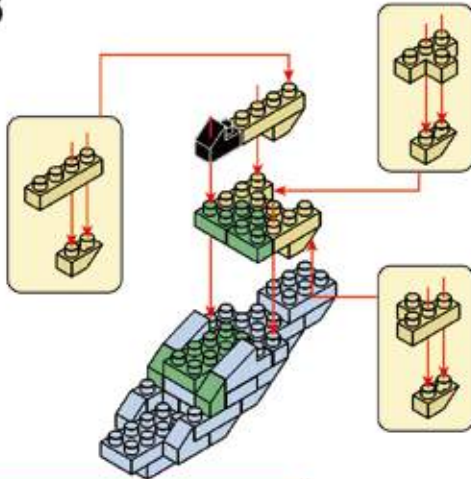

24

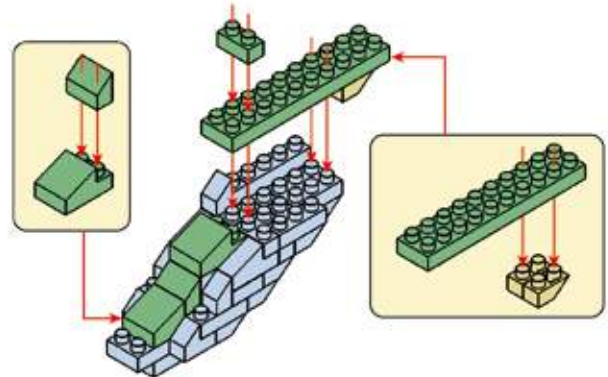

25

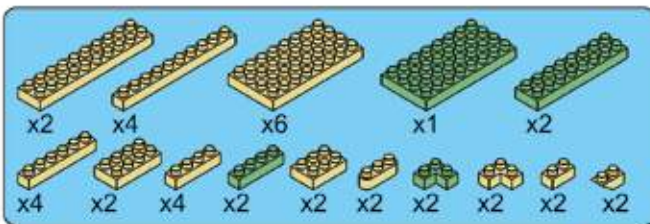
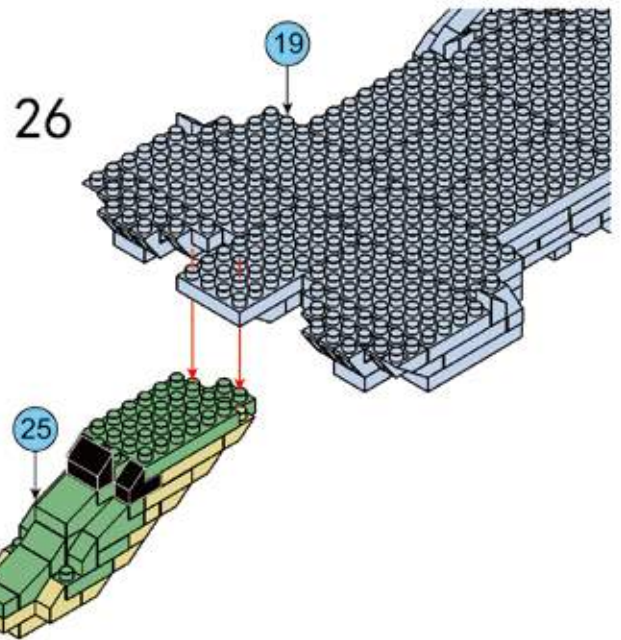
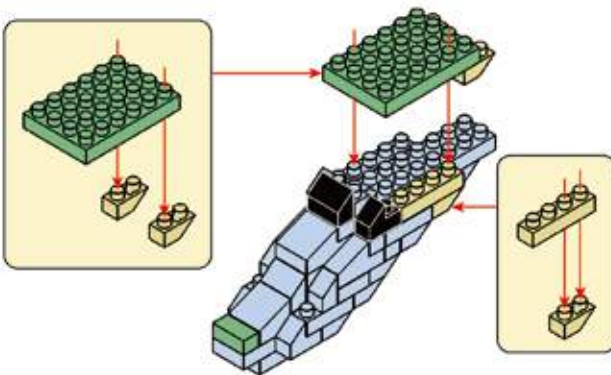

27

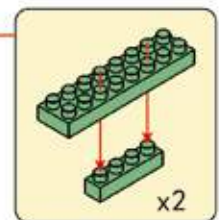
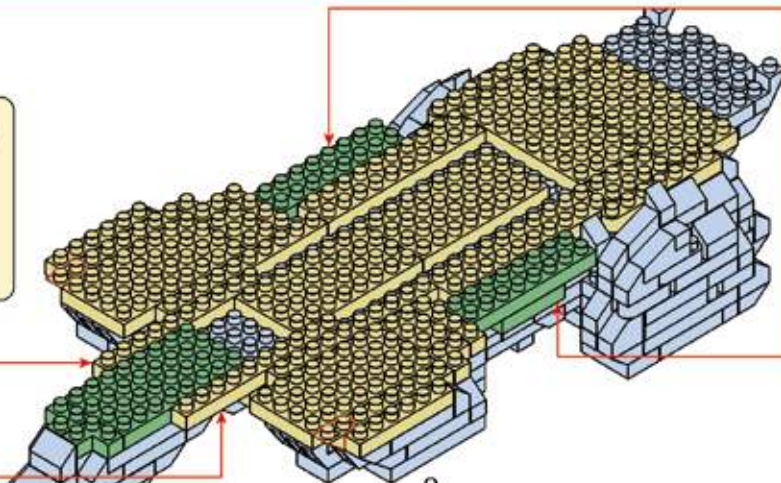
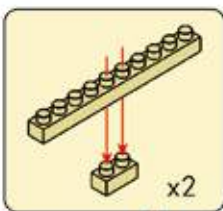

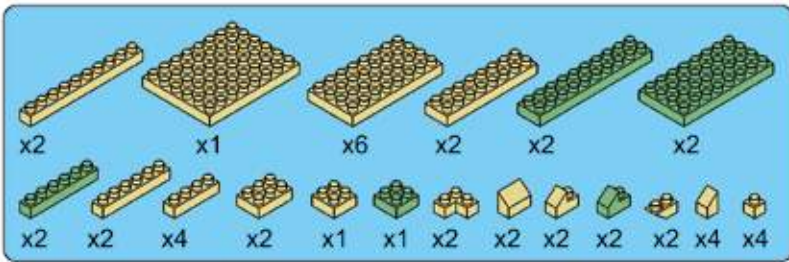

28

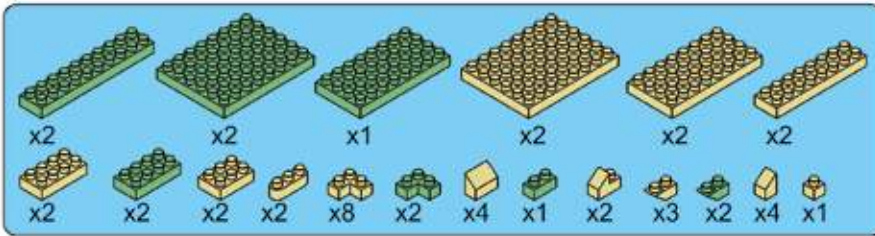
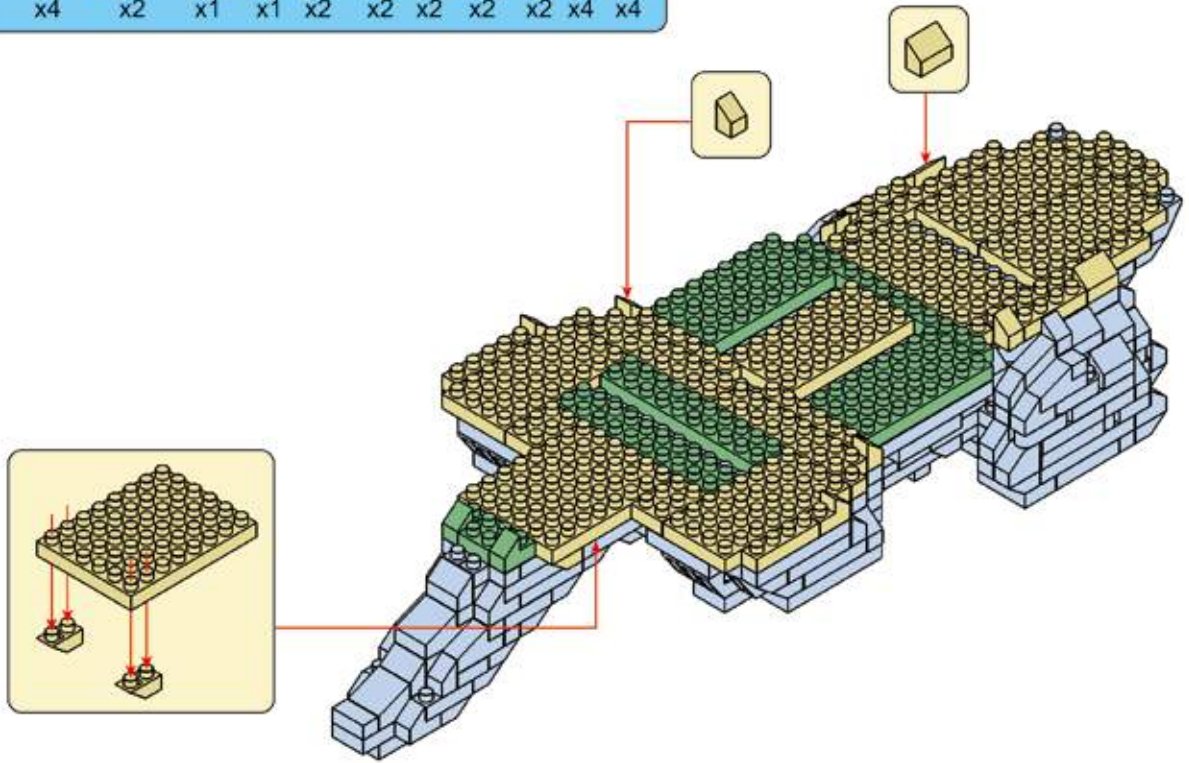

29

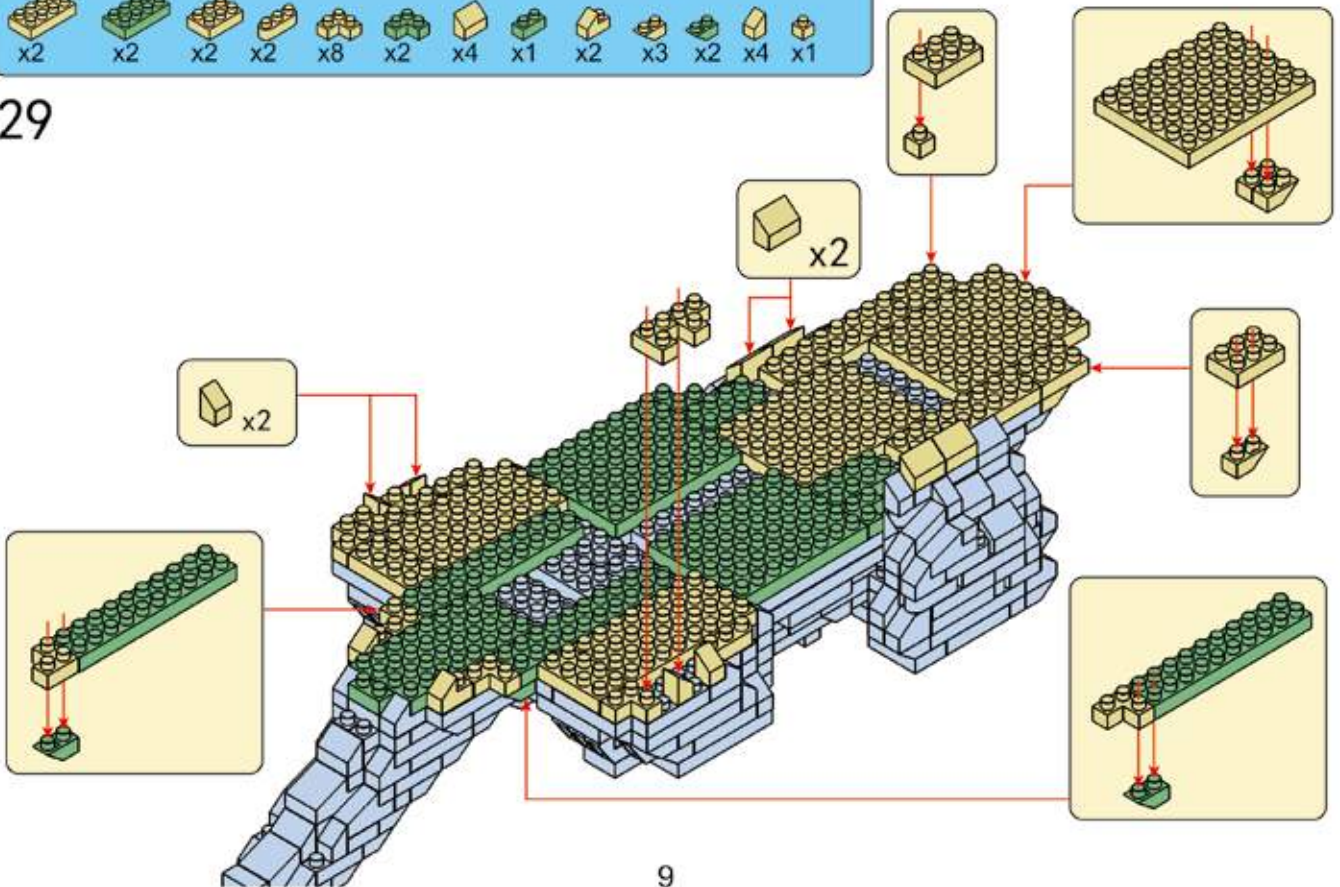

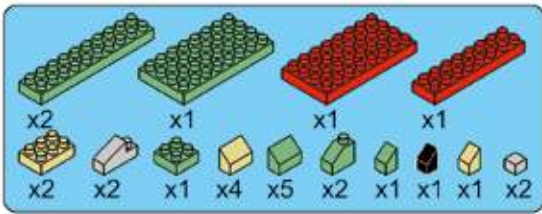

34

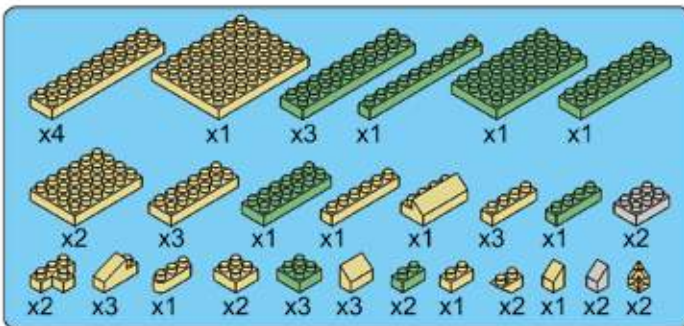
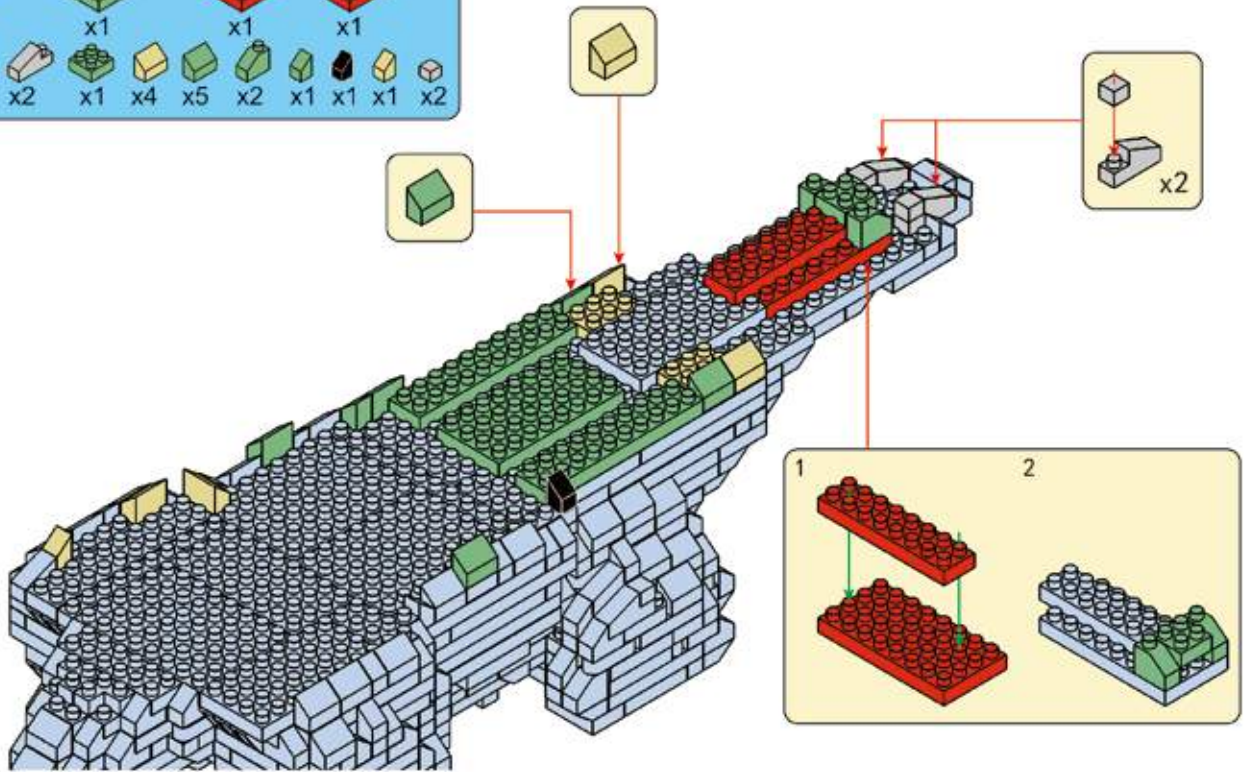

35

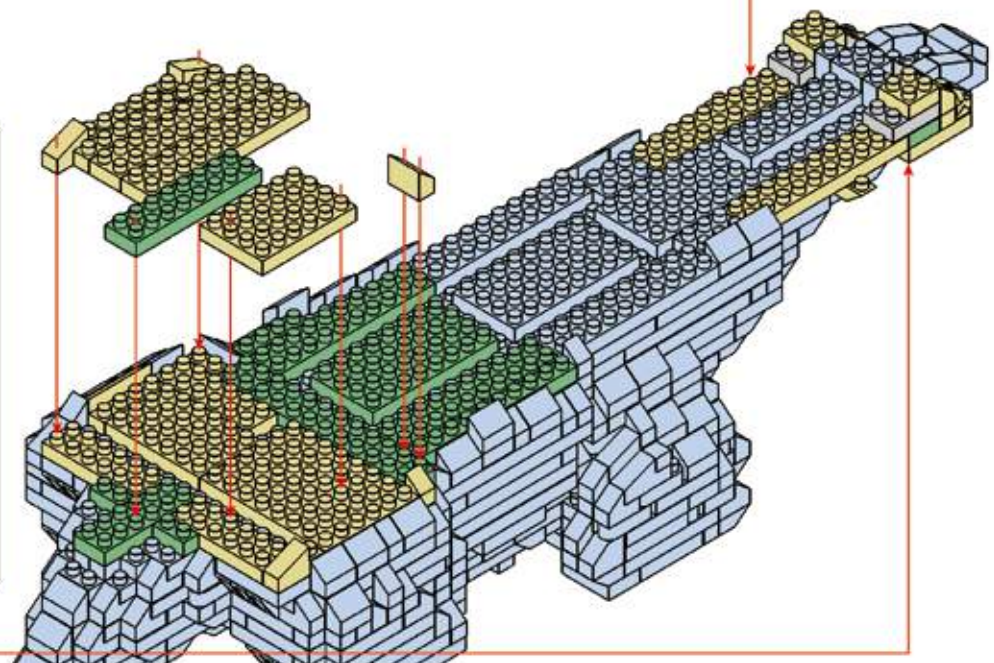
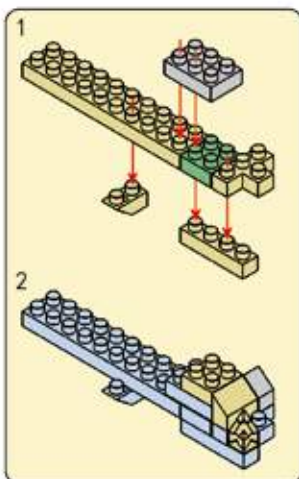
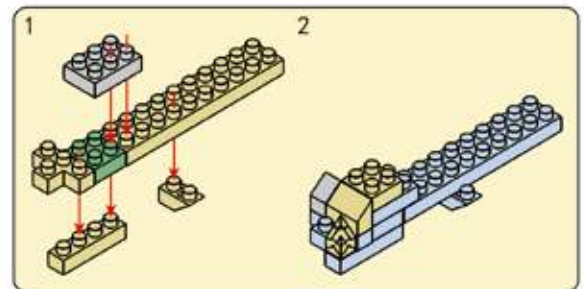

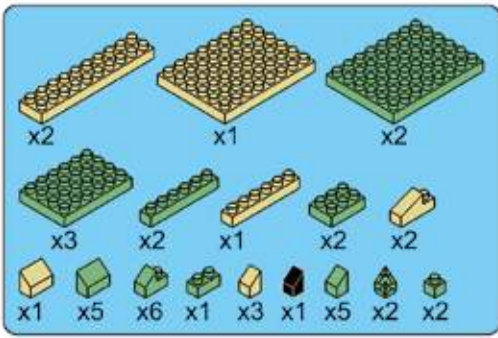

38

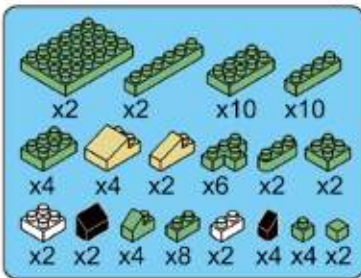
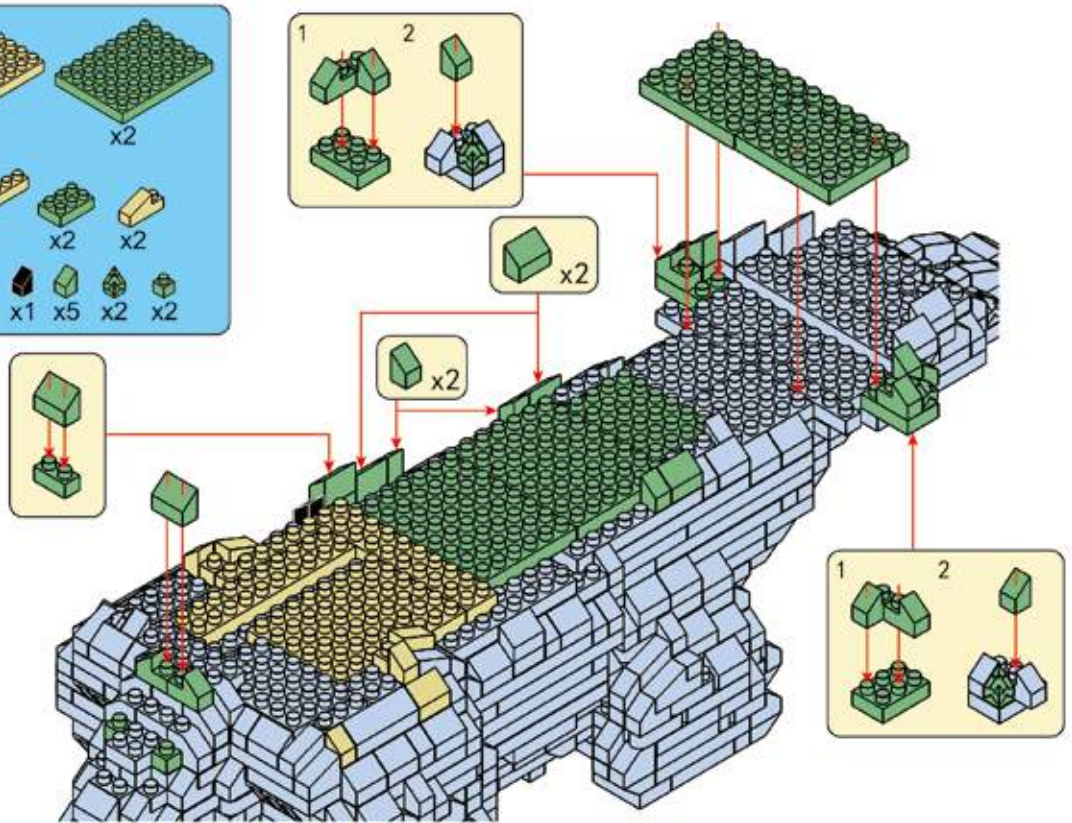

39

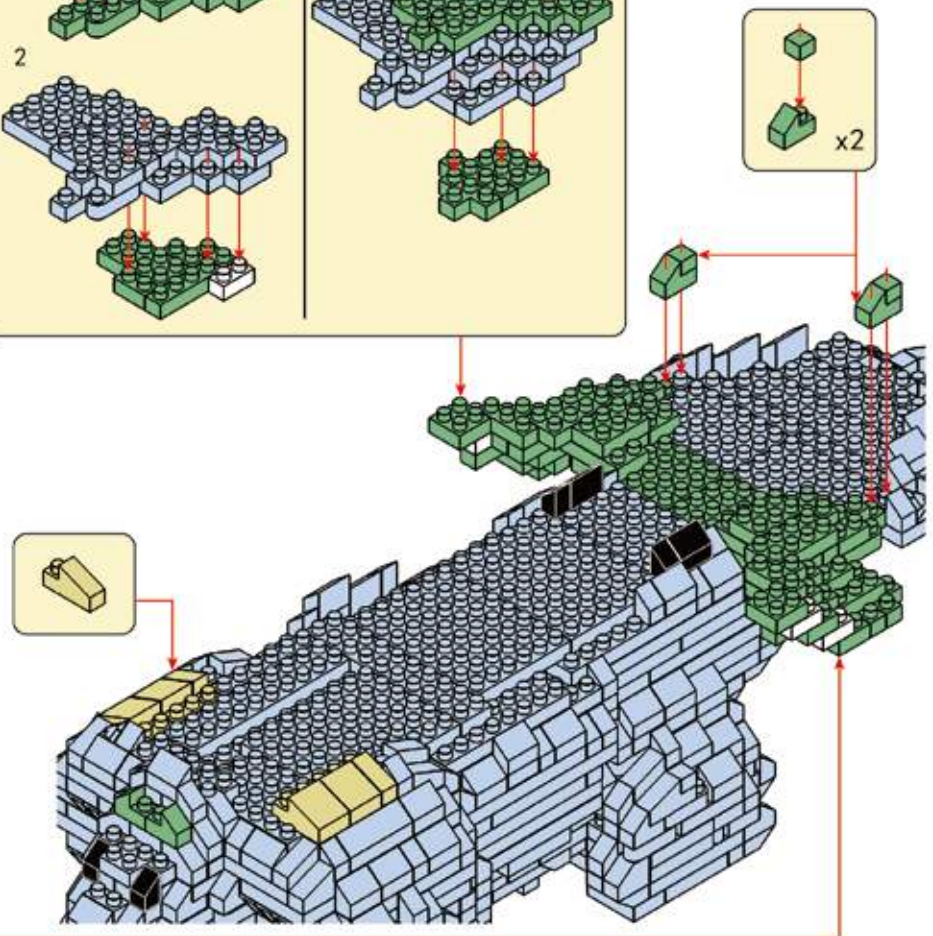
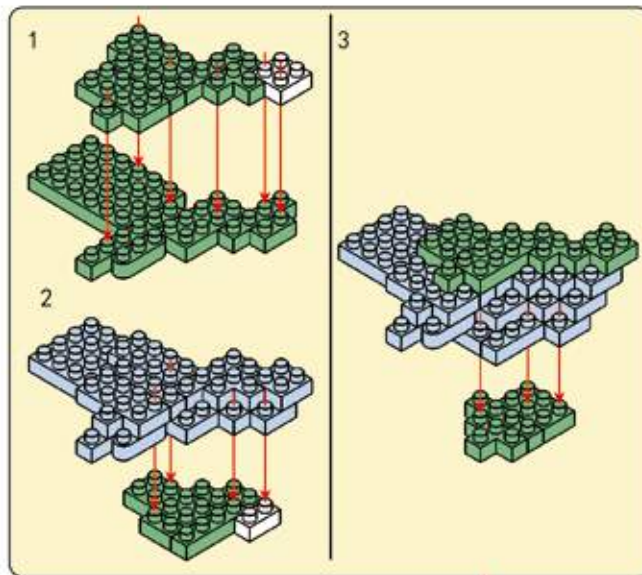
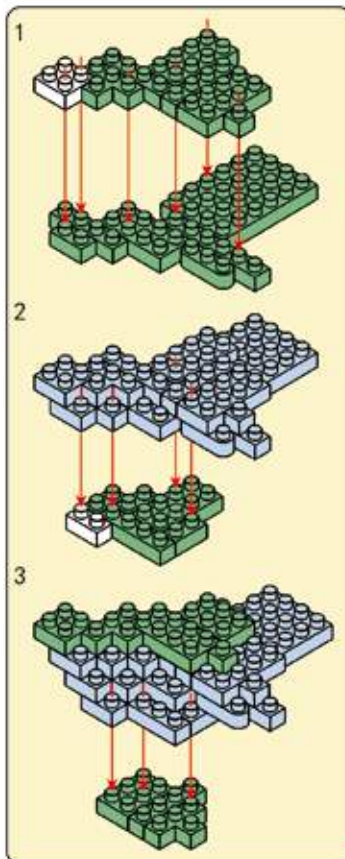

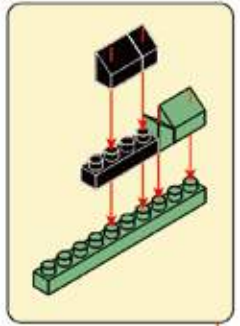
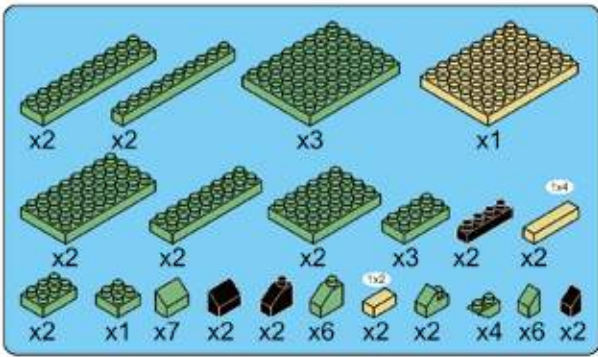

40

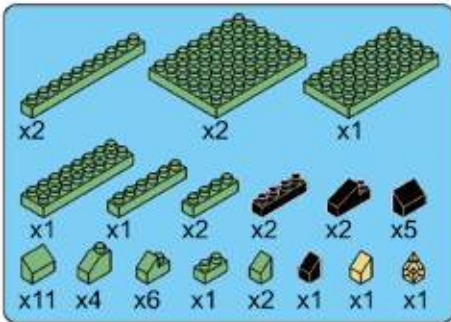
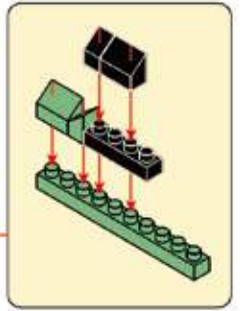
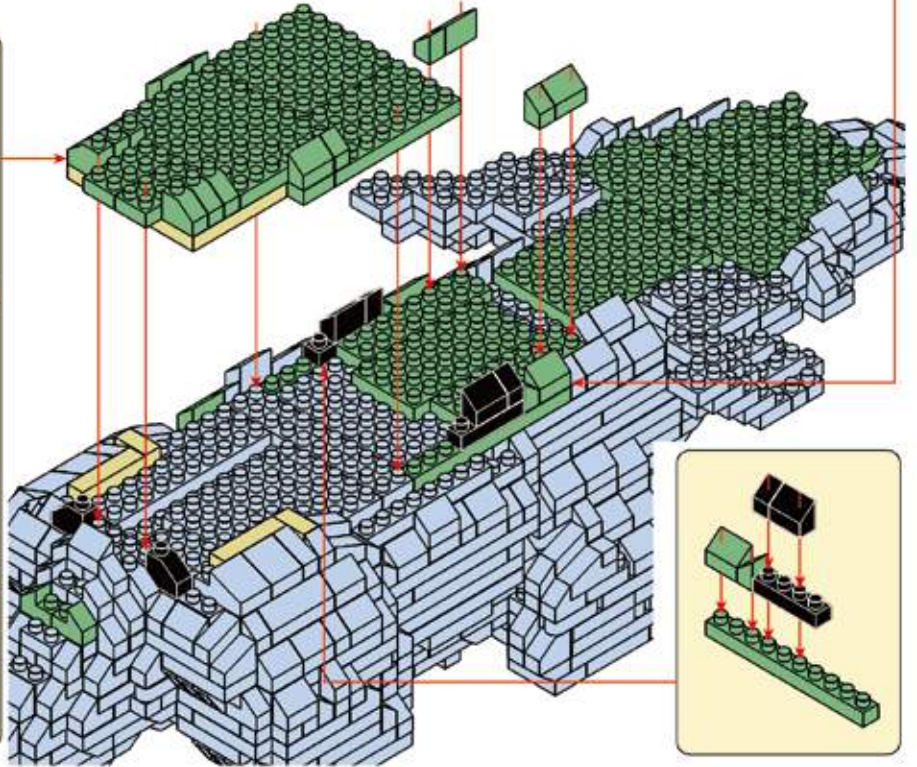
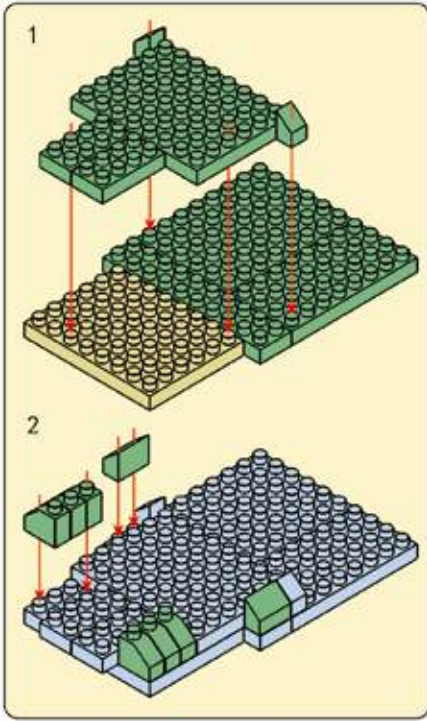

41

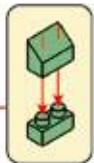
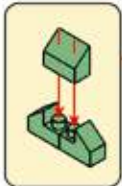
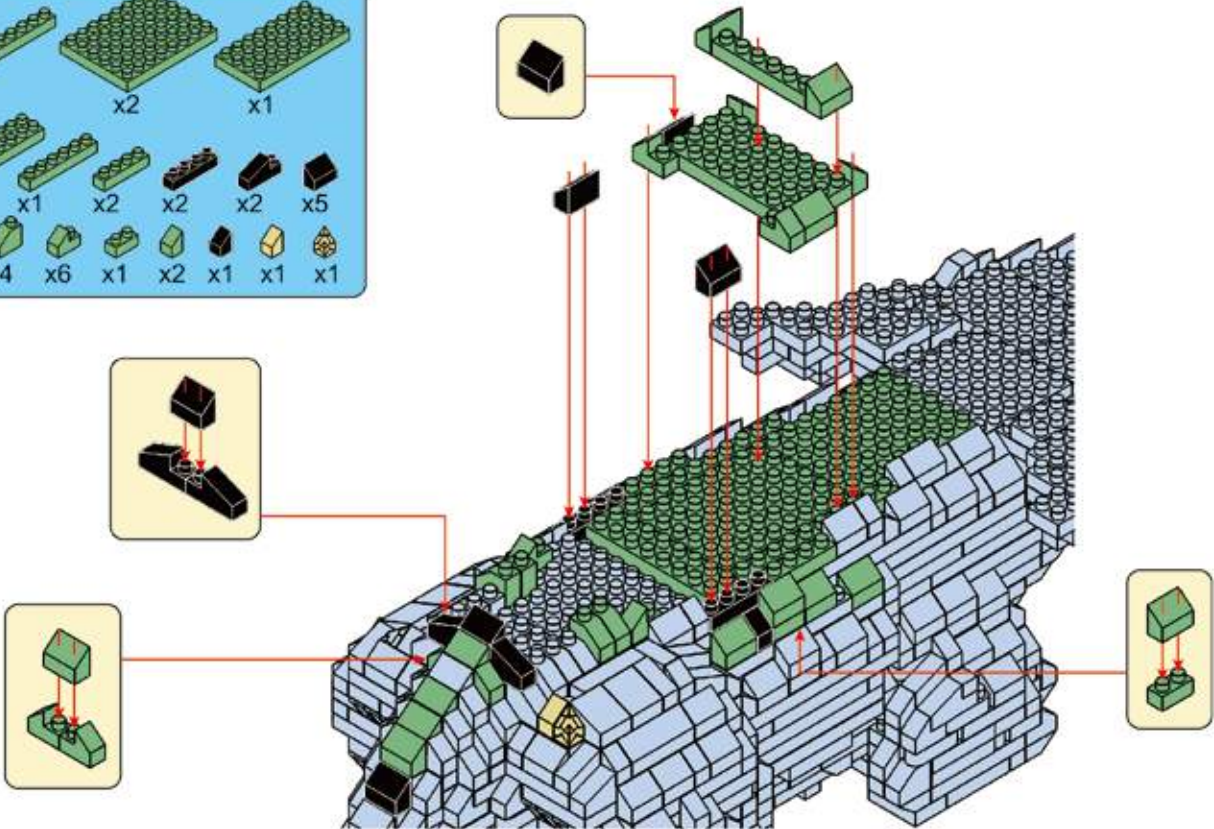

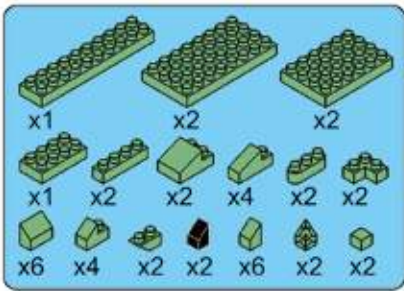

42

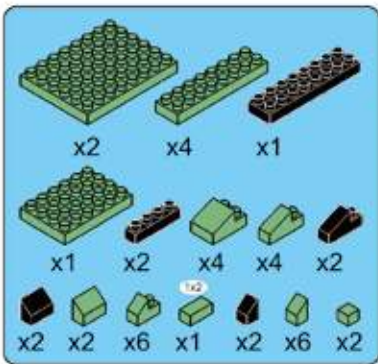
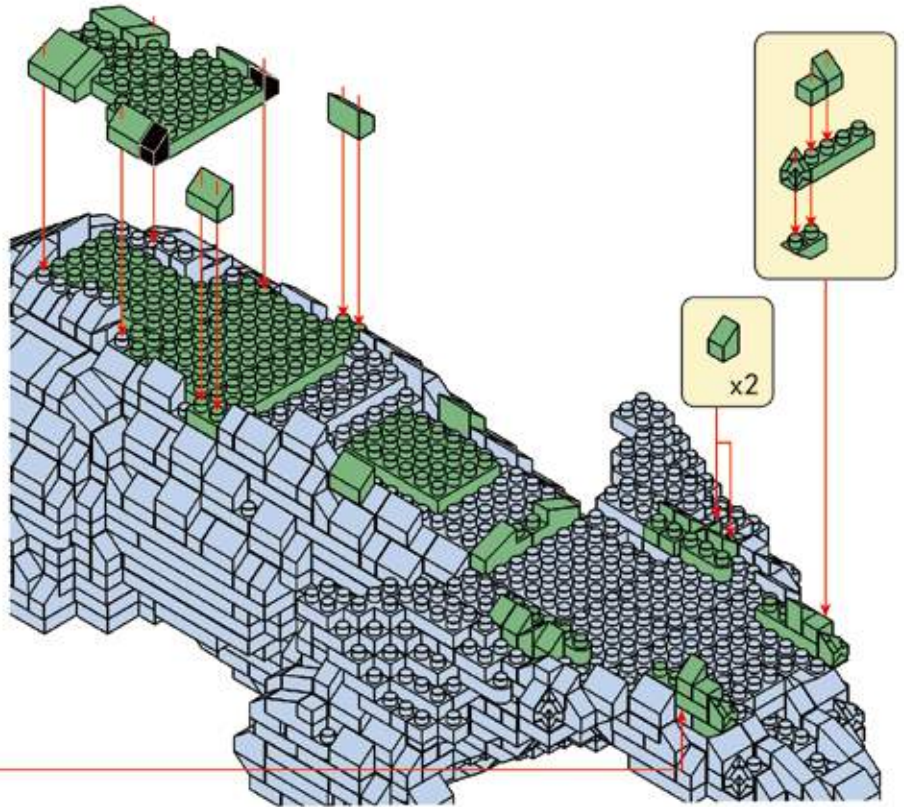
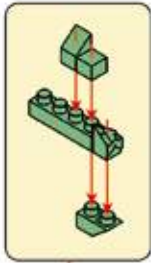

43

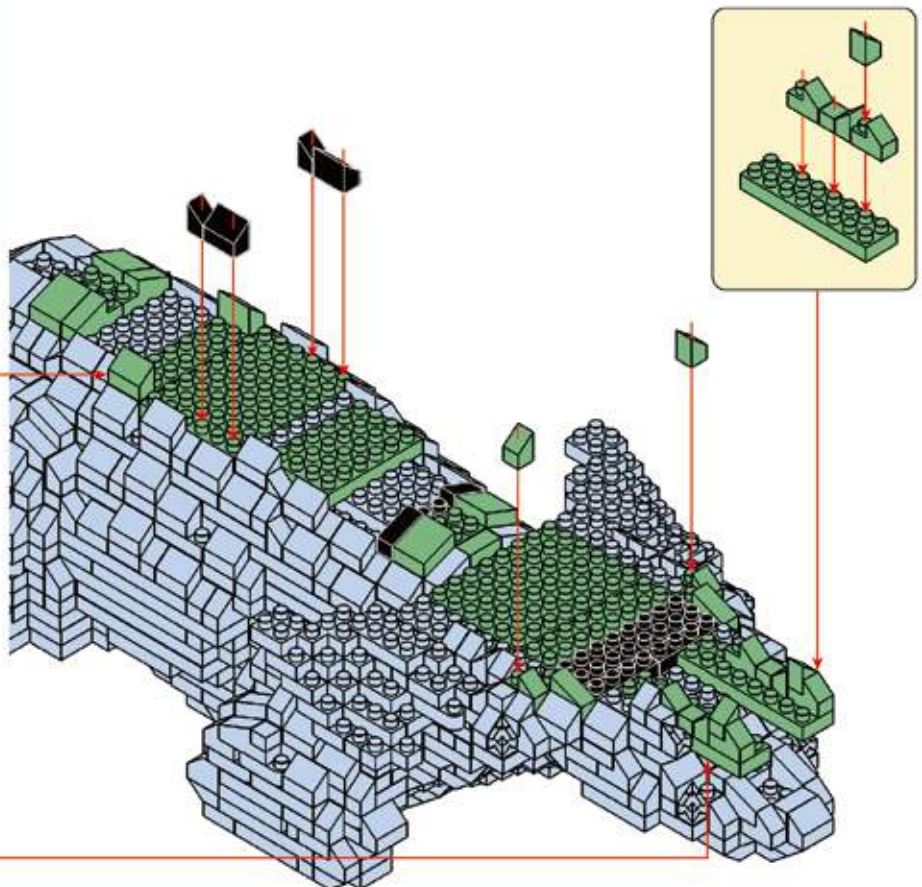
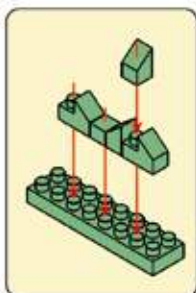
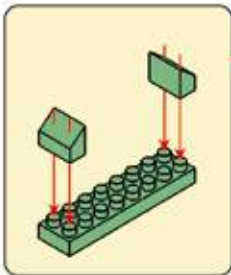

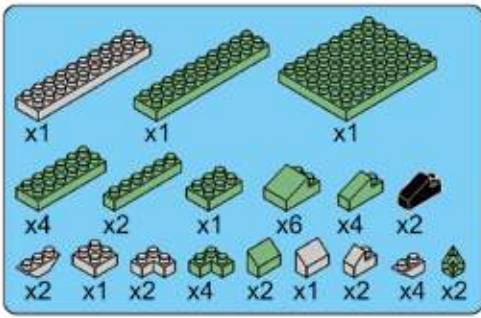

44

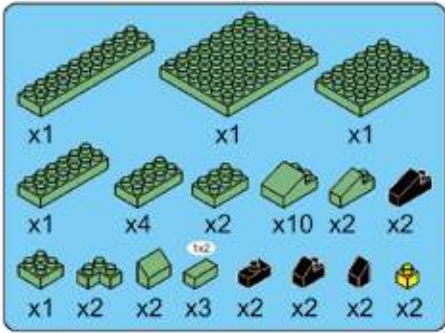
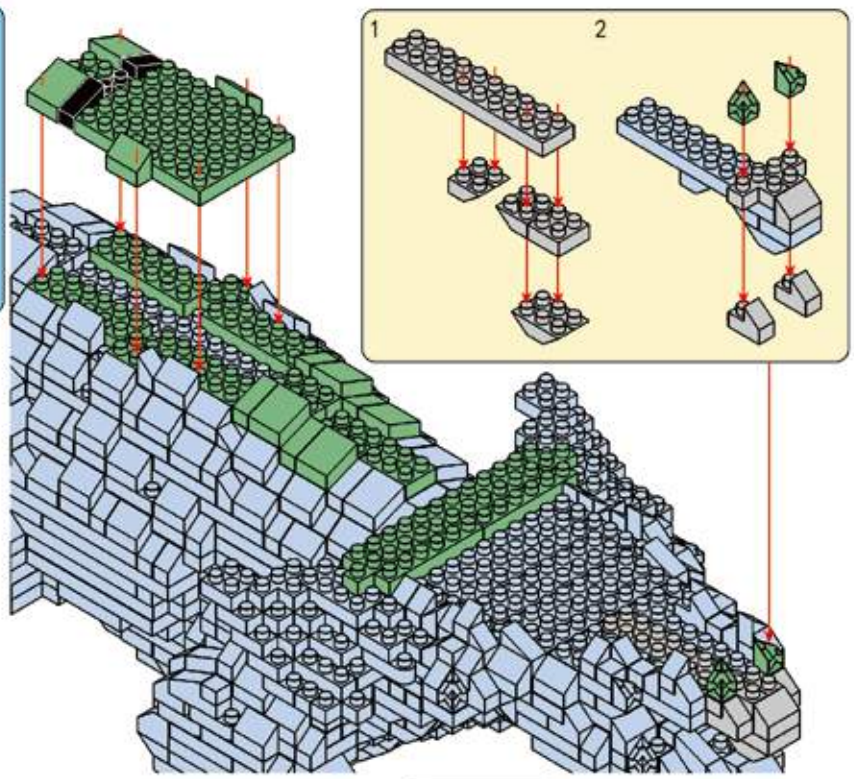

45

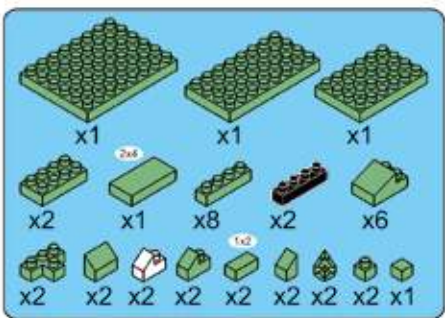
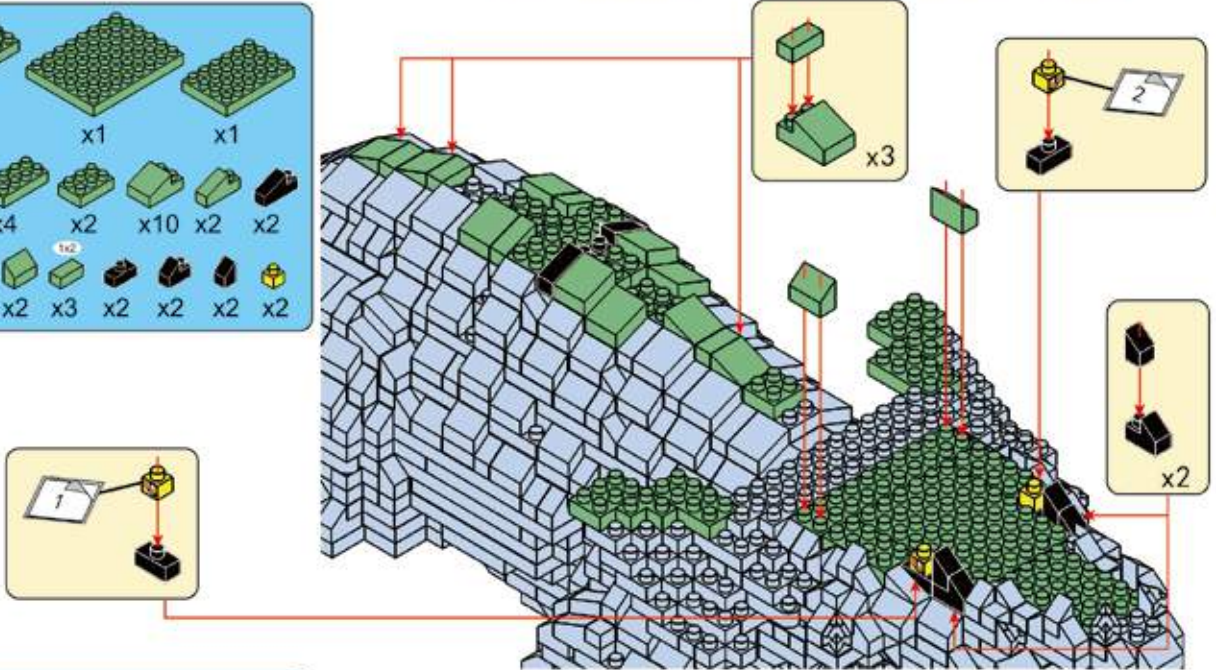

46

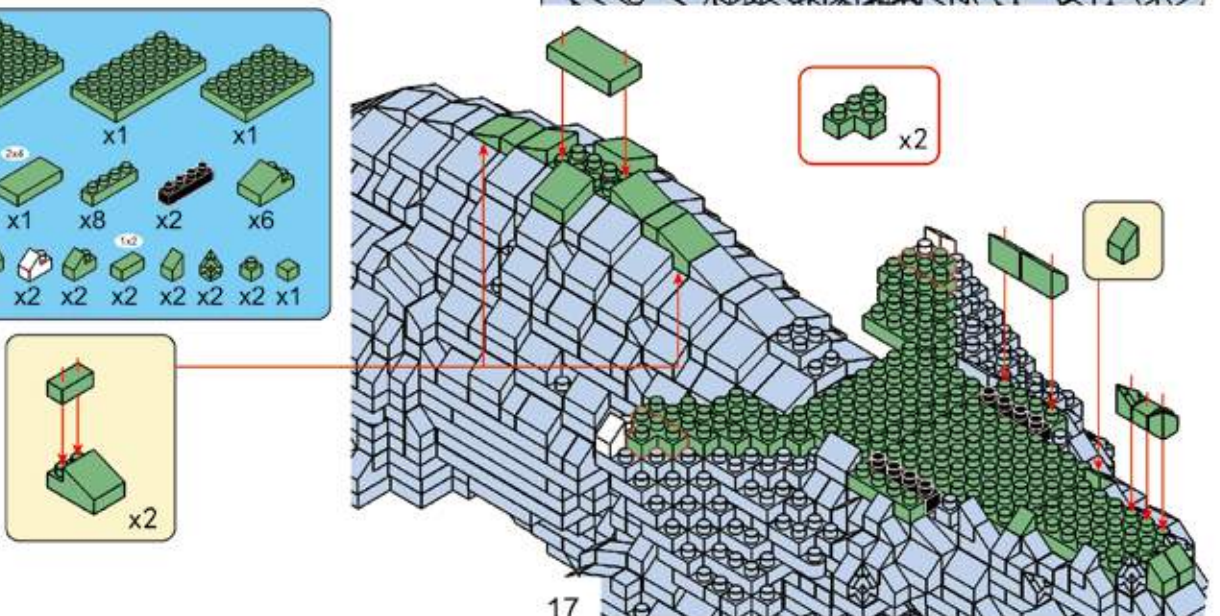

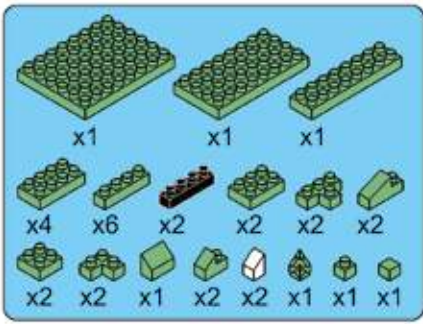

47

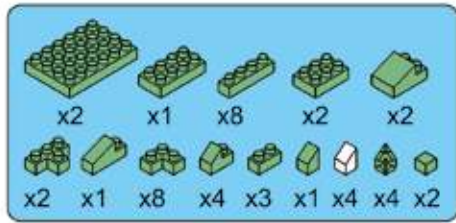
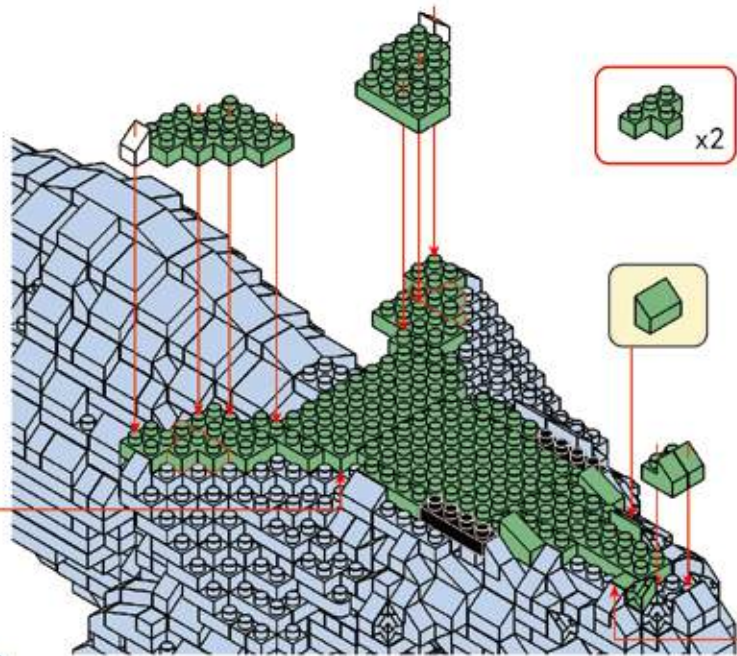
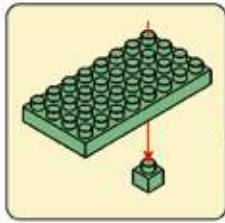

48

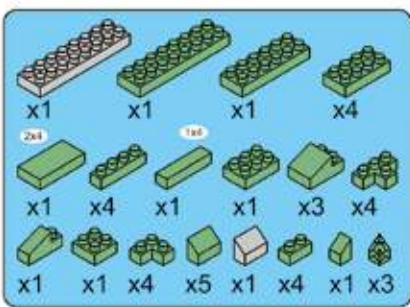
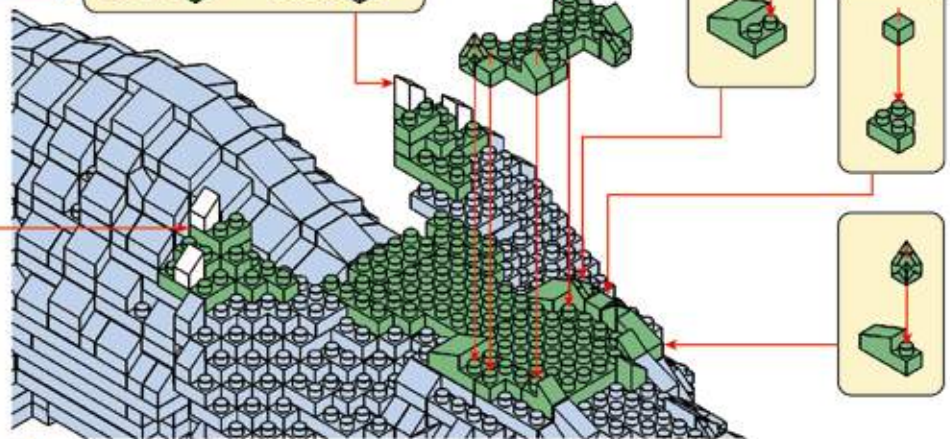
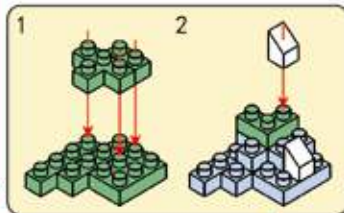

49

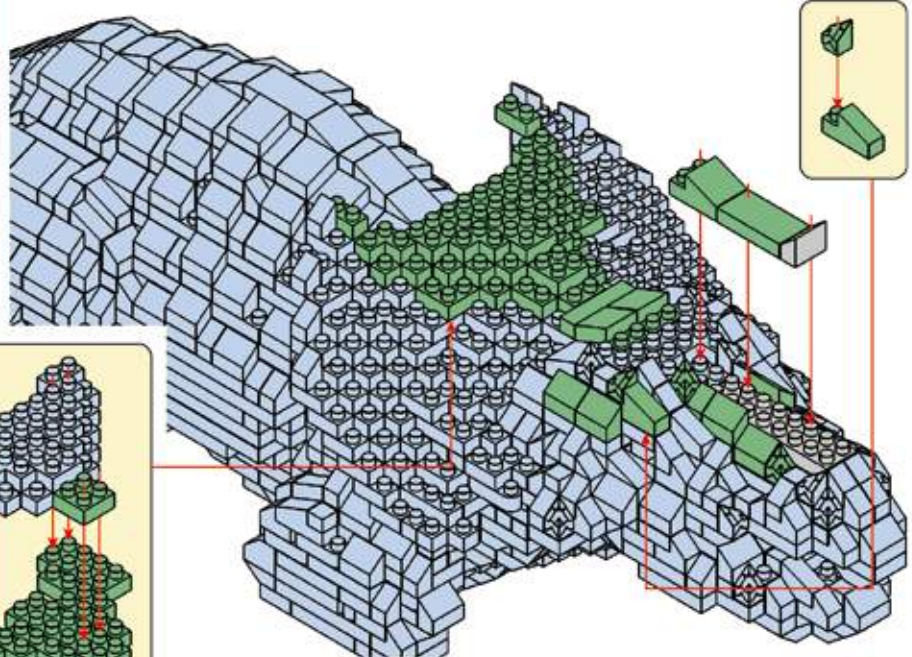
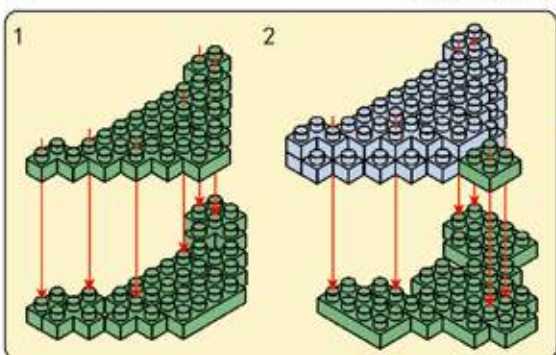

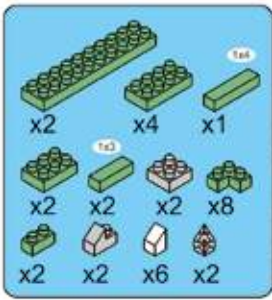

50

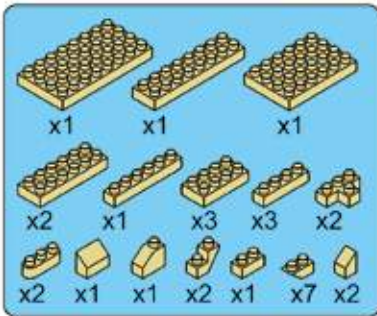
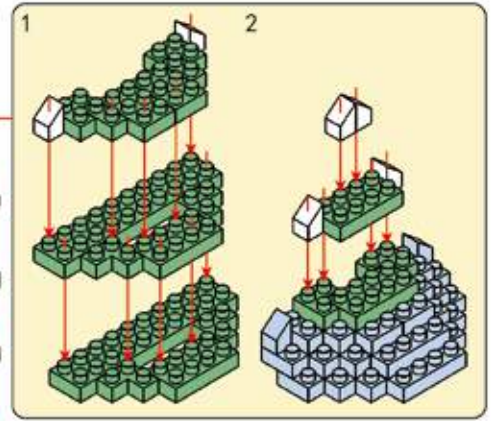
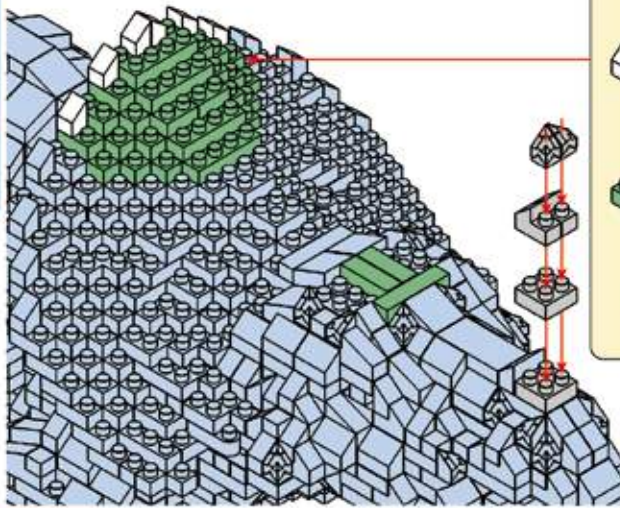

51

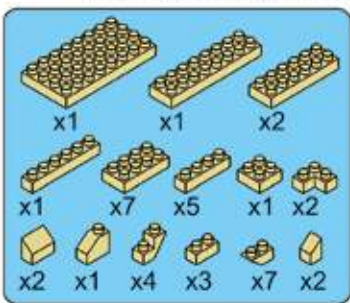
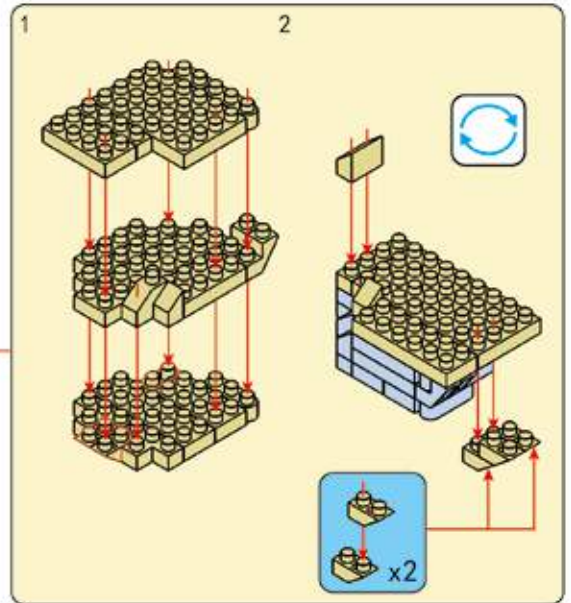
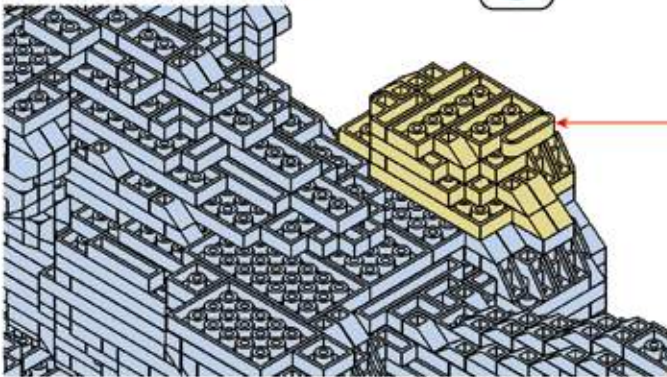

52

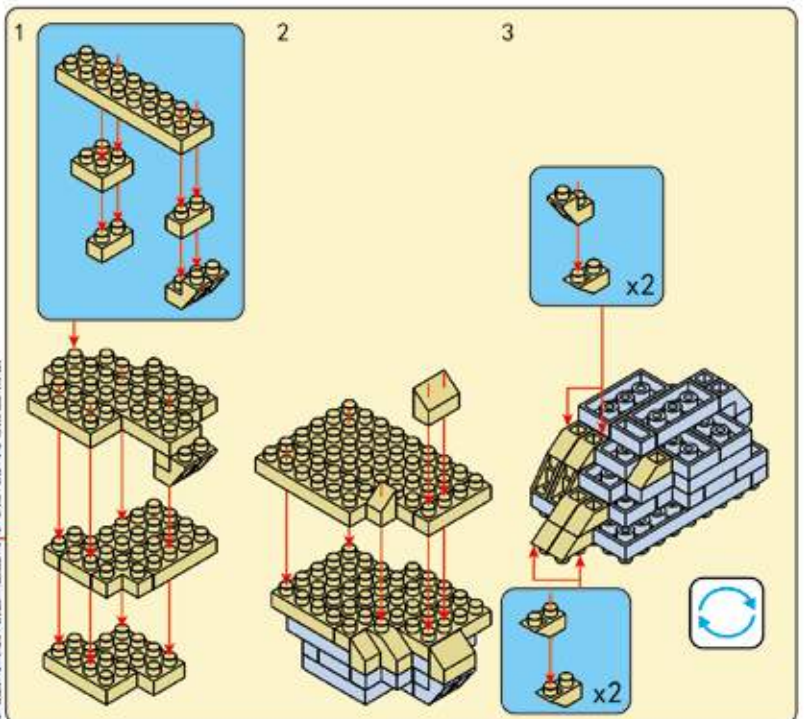
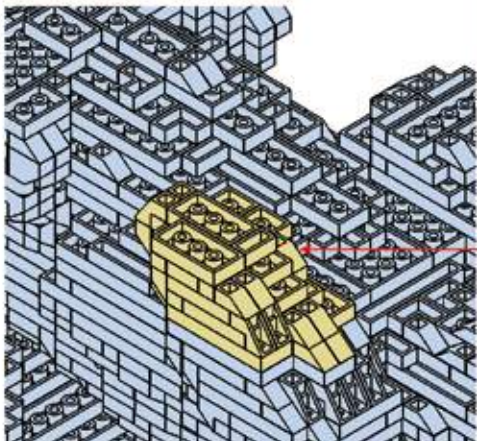

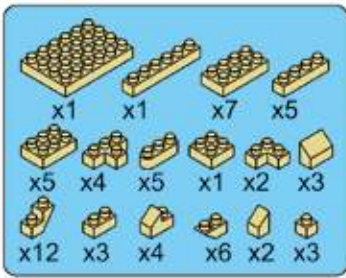

53

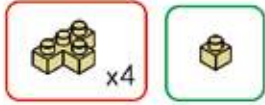
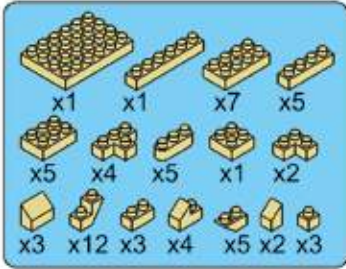
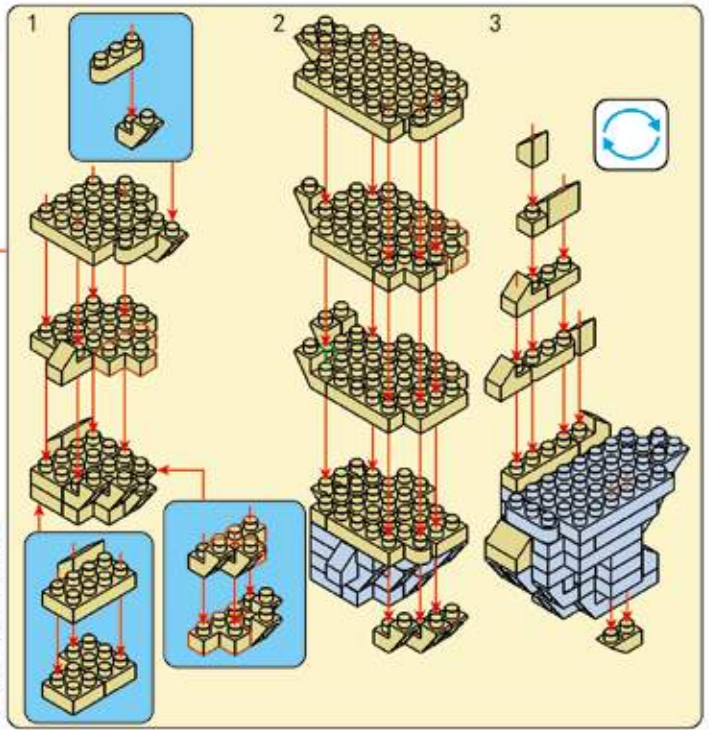
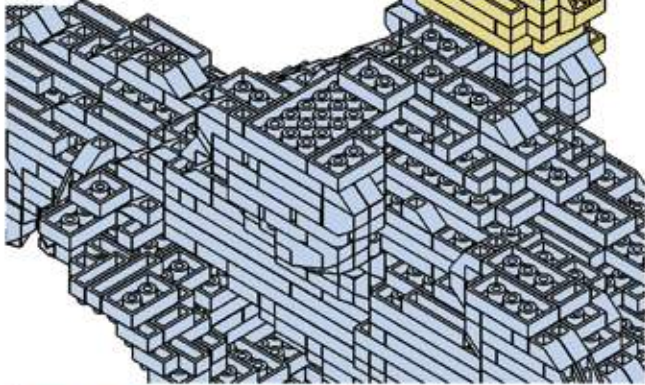

54

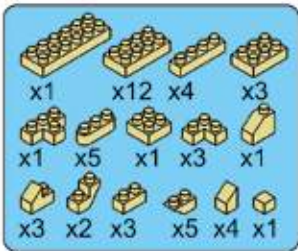
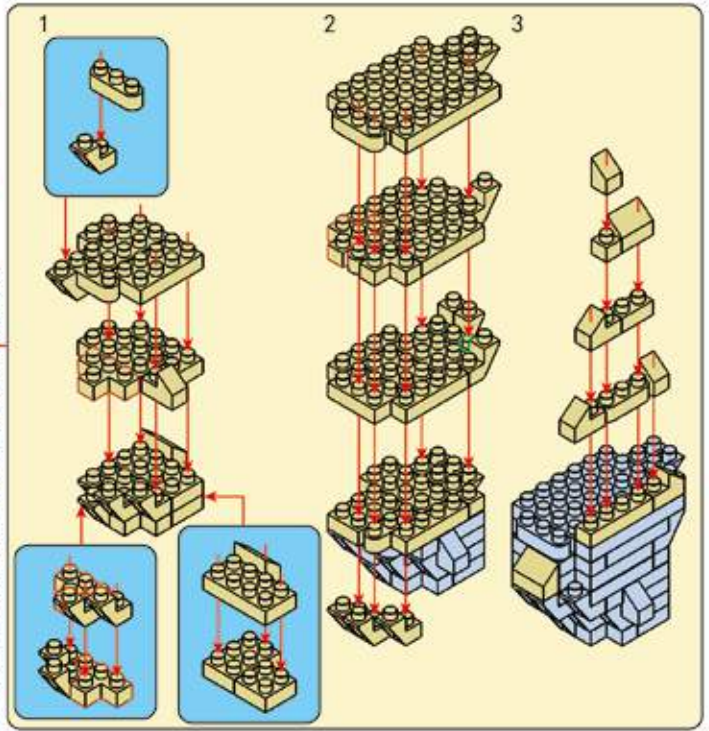
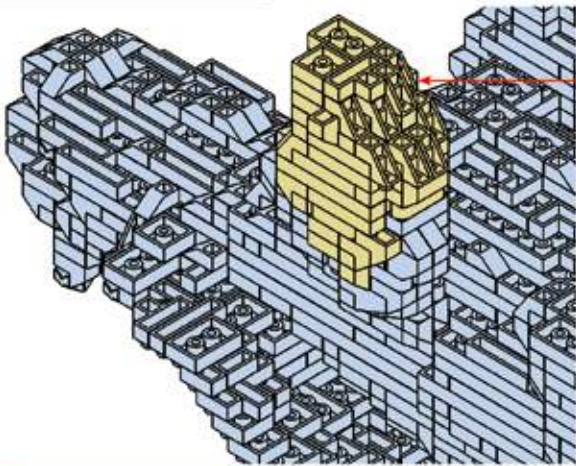

55

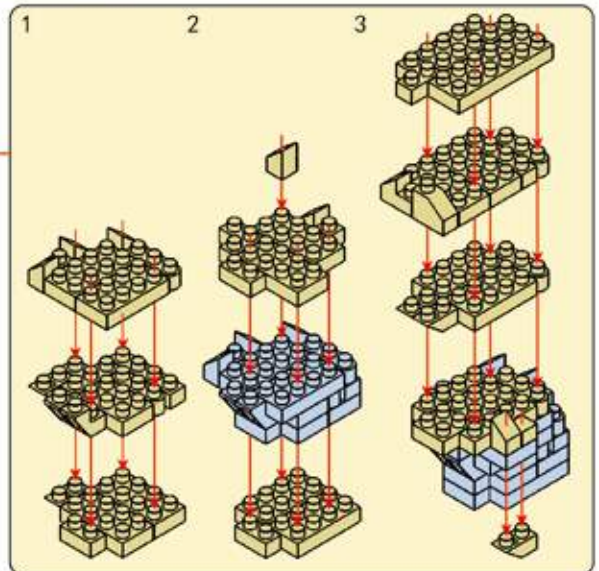
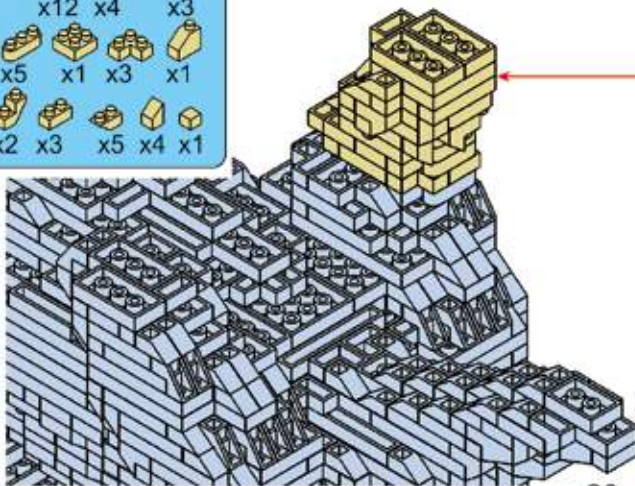

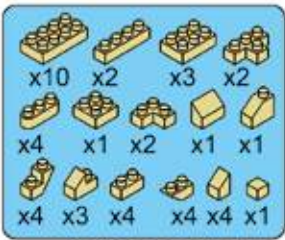

56

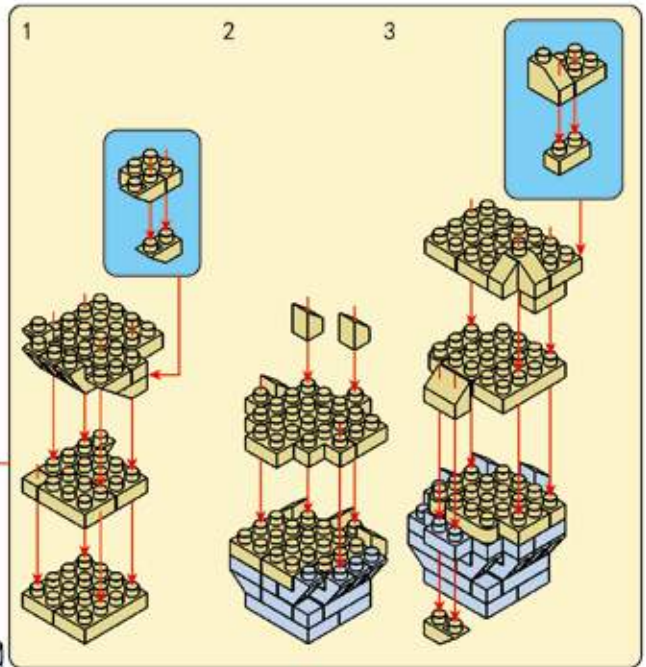
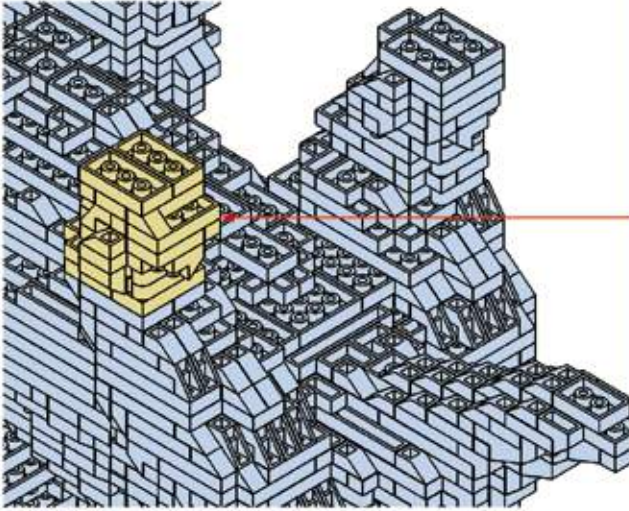

57

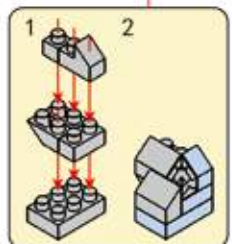
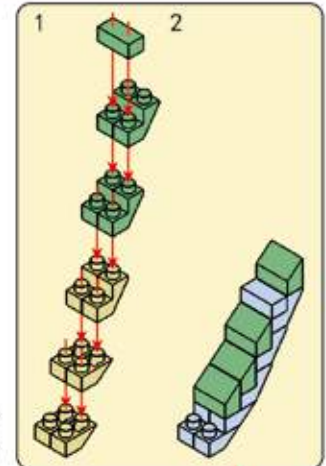
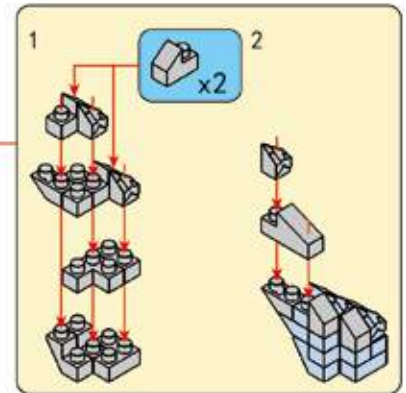
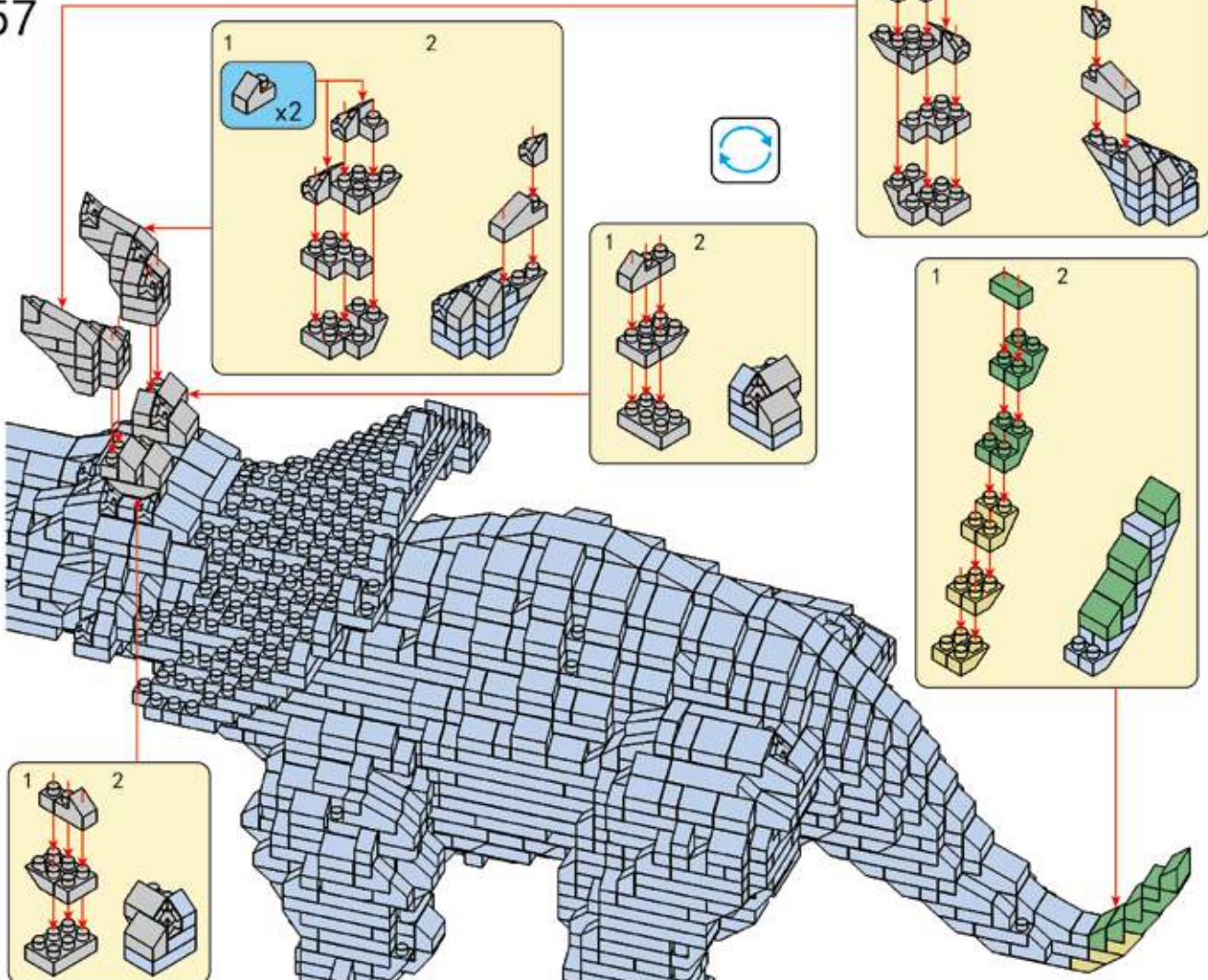

58

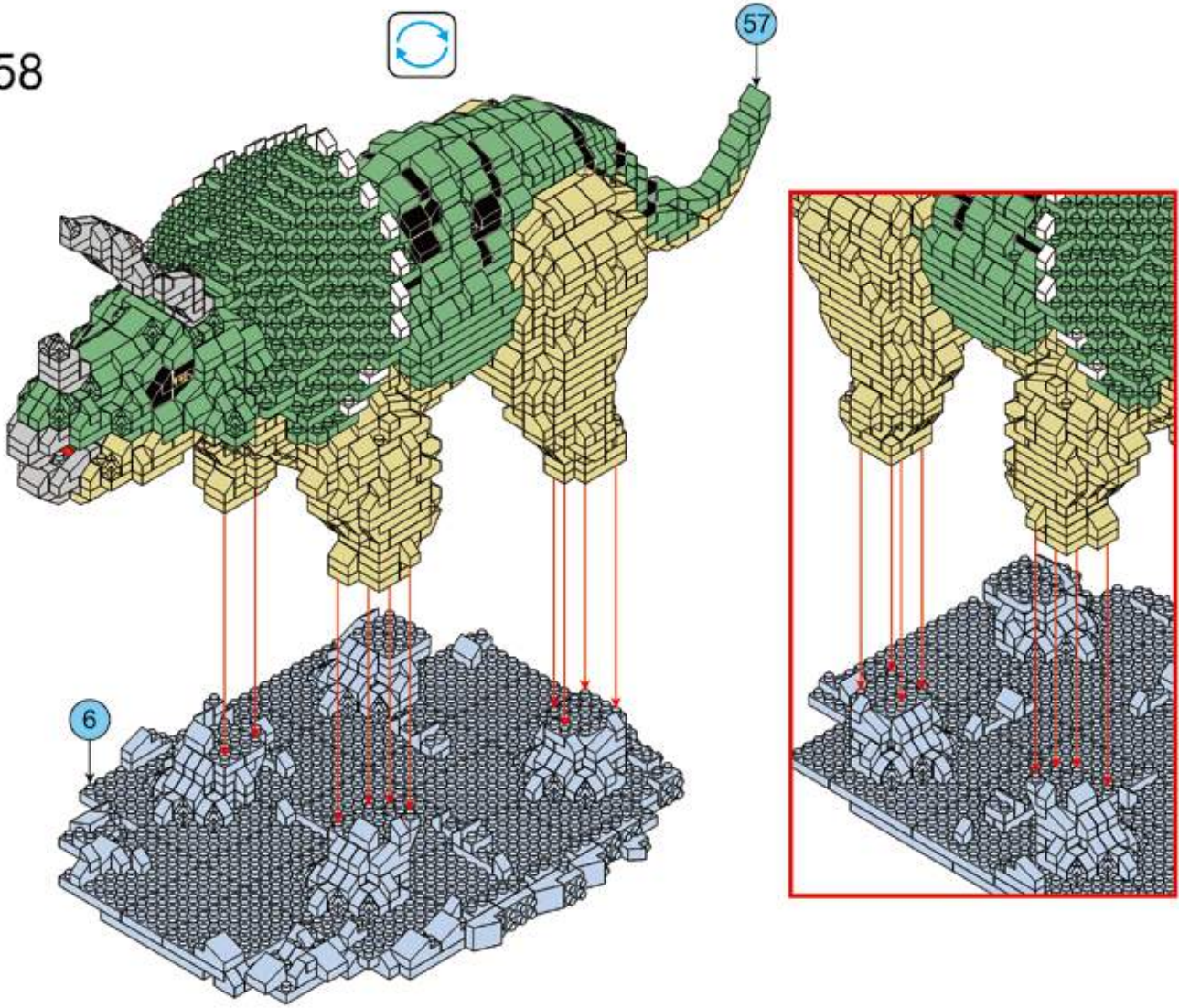

59

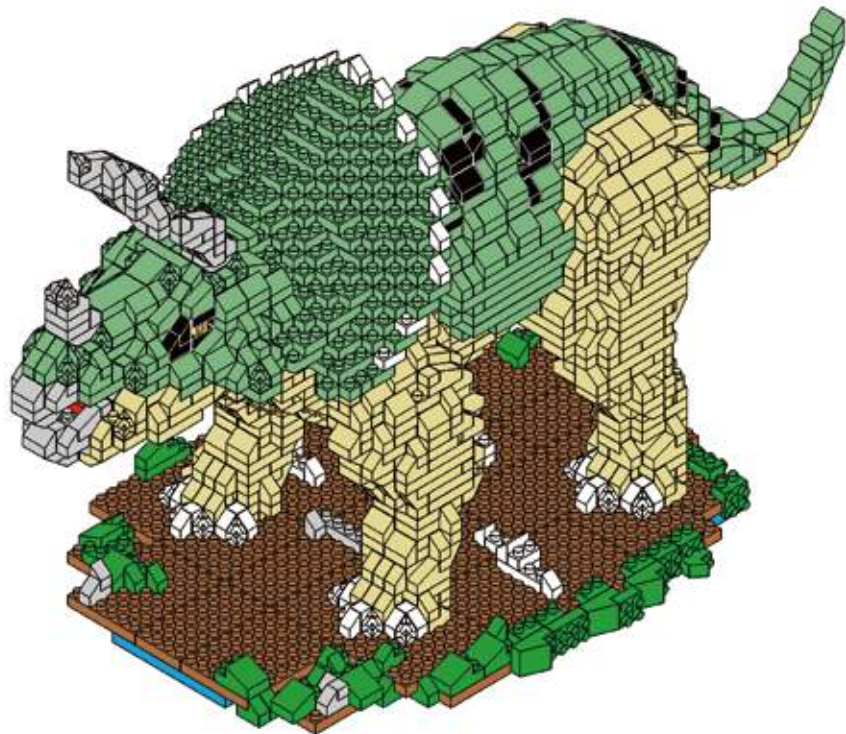

MINI BLOCK TRICERATOPS



10+
YEARS

Difficulty index:



MINI BLOCK TYRANNOSAURUS REX



10+
YEARS

2018 PCS

Difficulty index:
★★★★★

MINI BLOCK TYRANNOSAURUS REX

keycode:43341016
ADULT ASSISTANCE IS RECOMMENDED.
PRODUCT MAY SLIGHTLY FROM IMAGE SHOWN.

 **WARNING:**
CHOKING HAZARD - SMALL PARTS.
NOT FOR CHILDREN UNDER 3 YEARS.

10+
YEARS

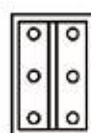
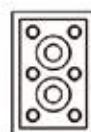
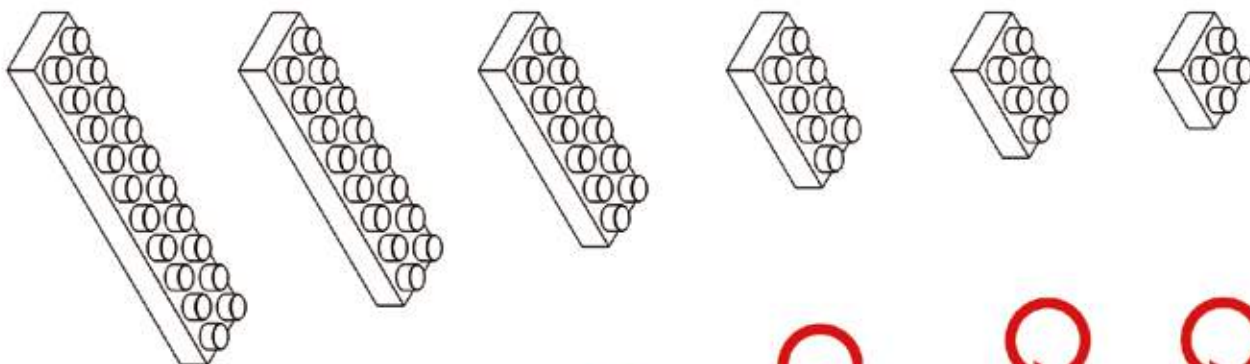

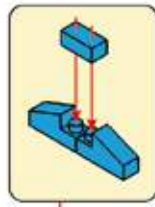
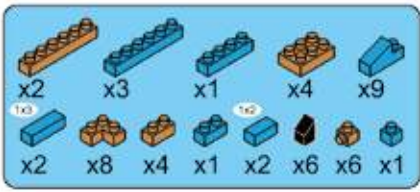

4

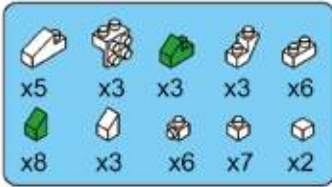
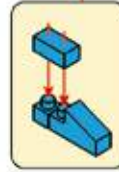
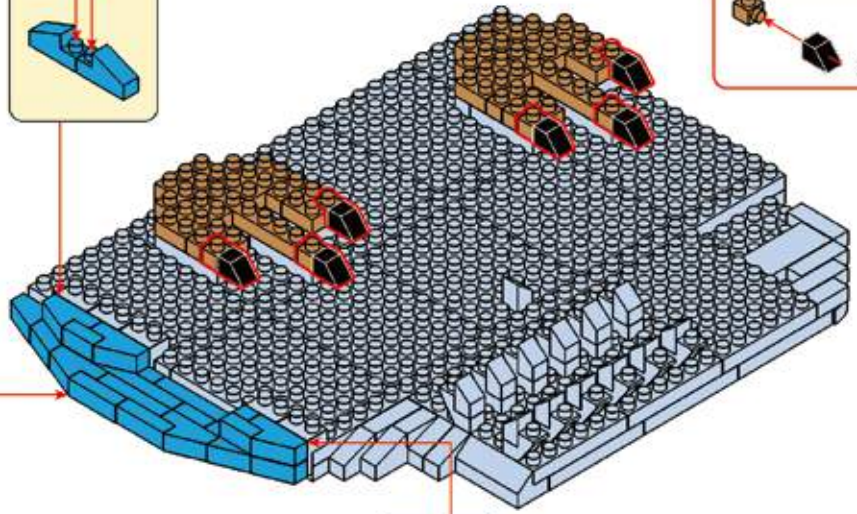
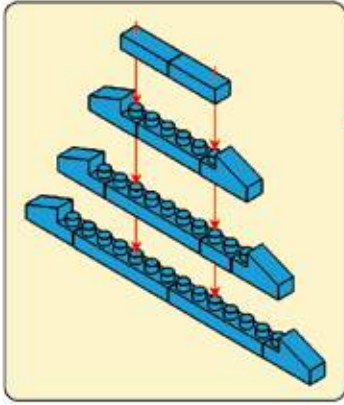

5

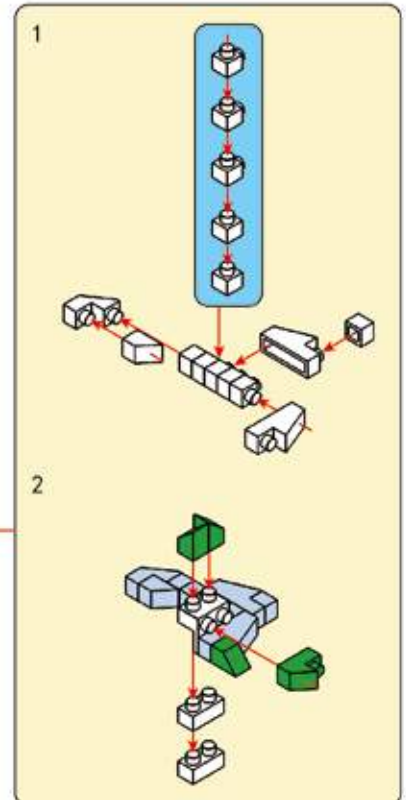
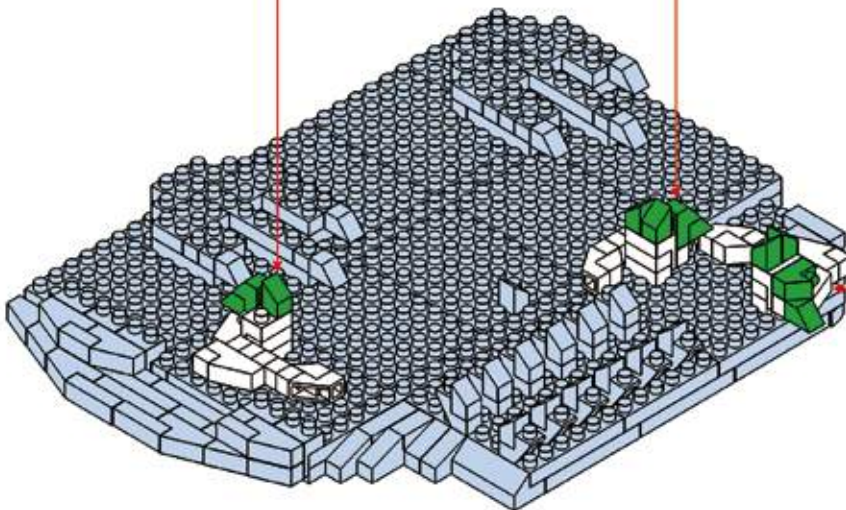
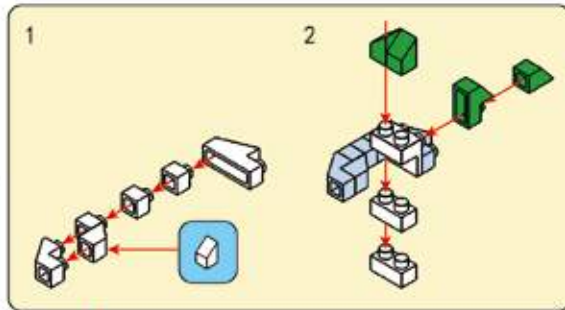
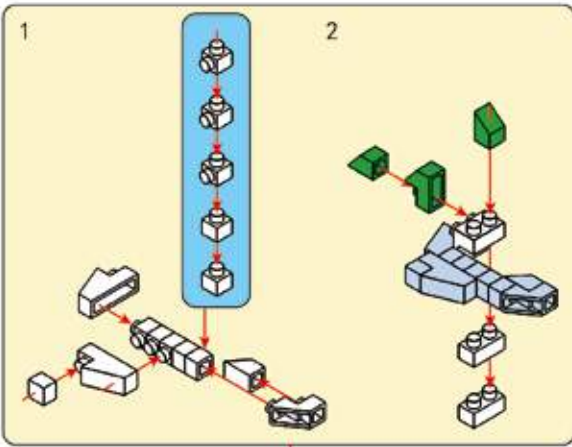

- x12
- x3
- x6
- x36
- x12
- x12

6

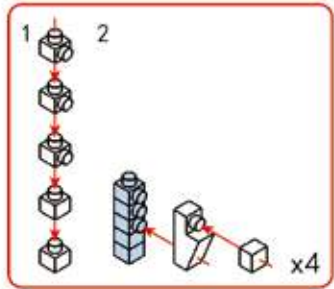
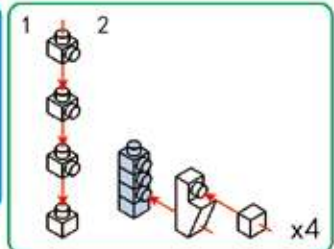
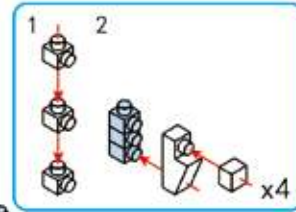
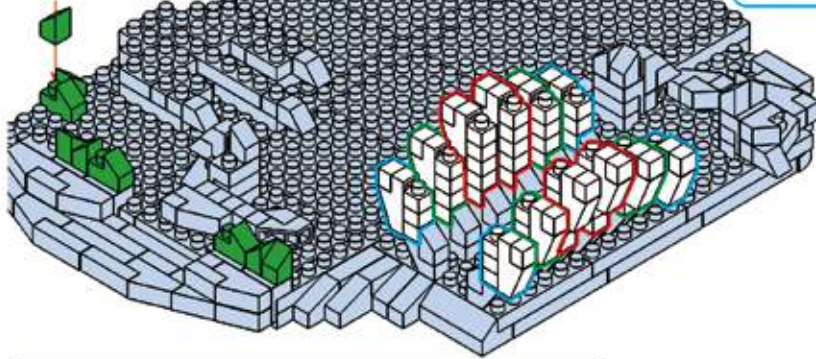

- x2
- x6
- x12
- x5
- x1
- x12
- x9
- x3
- x1
- x8
- x3
- x4
- x4
- x6
- x11
- x7
- x2
- x2
- x6

7

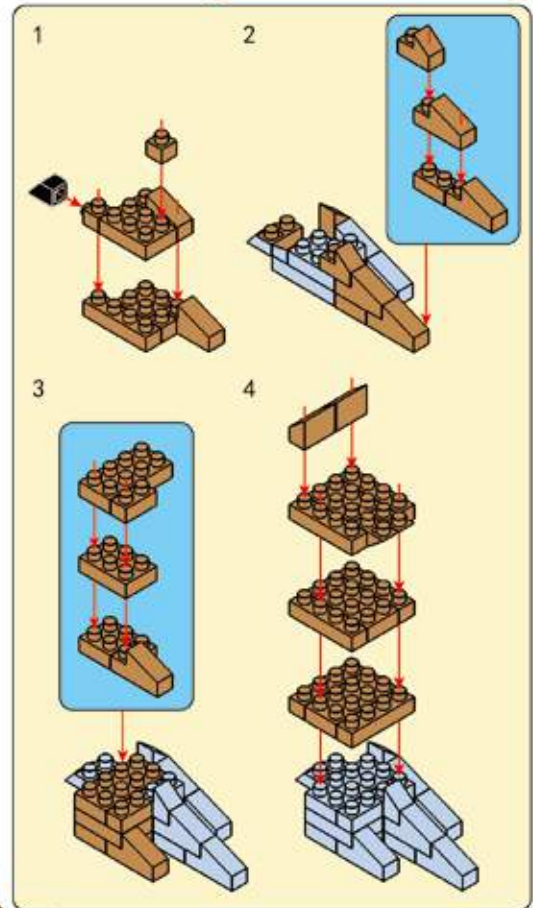
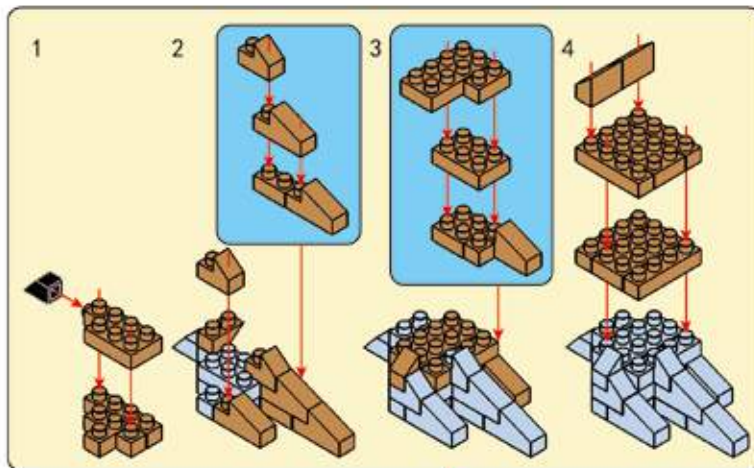

- x3

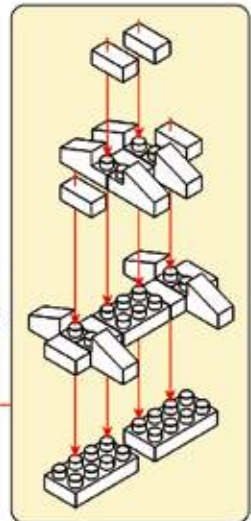
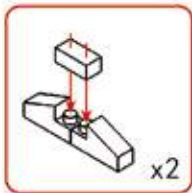
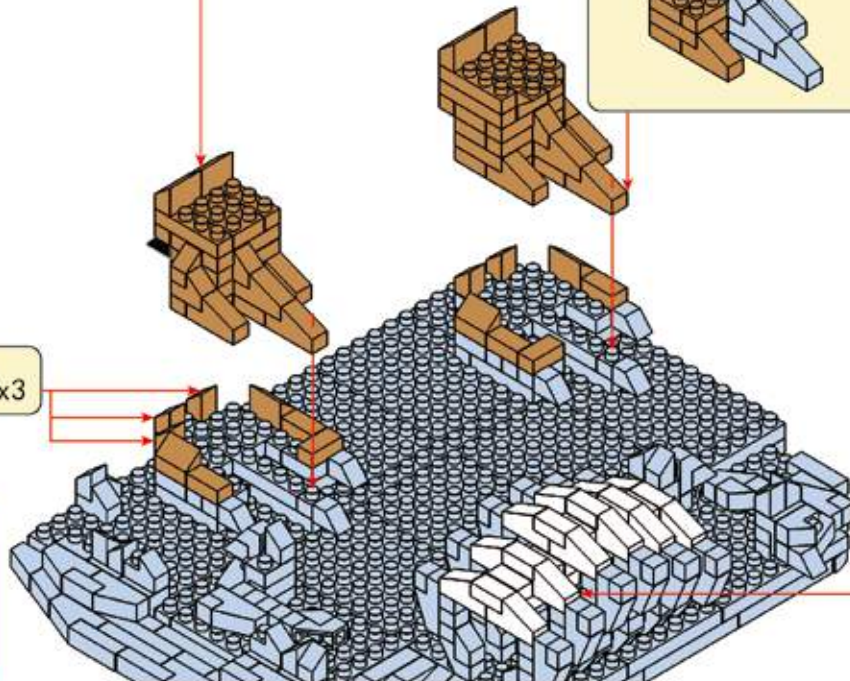

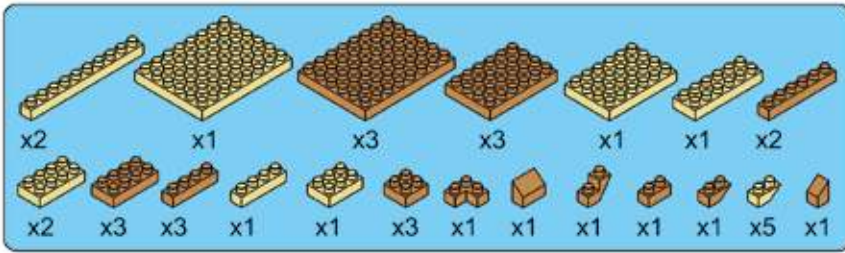

8

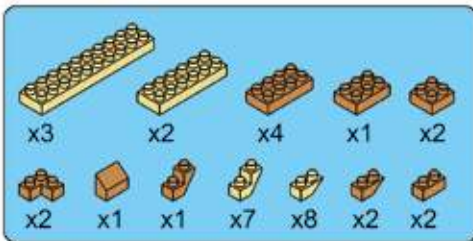
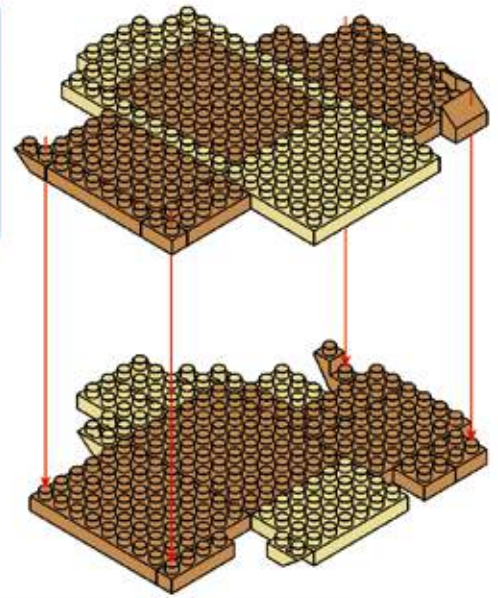

9

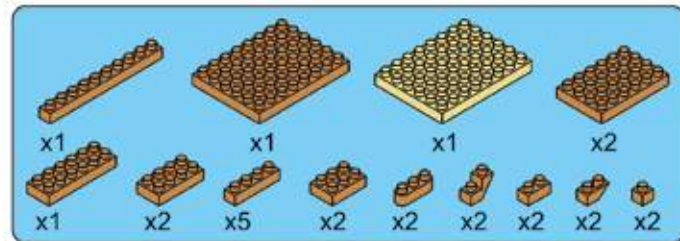

10

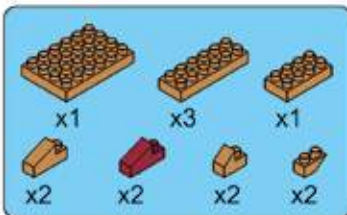
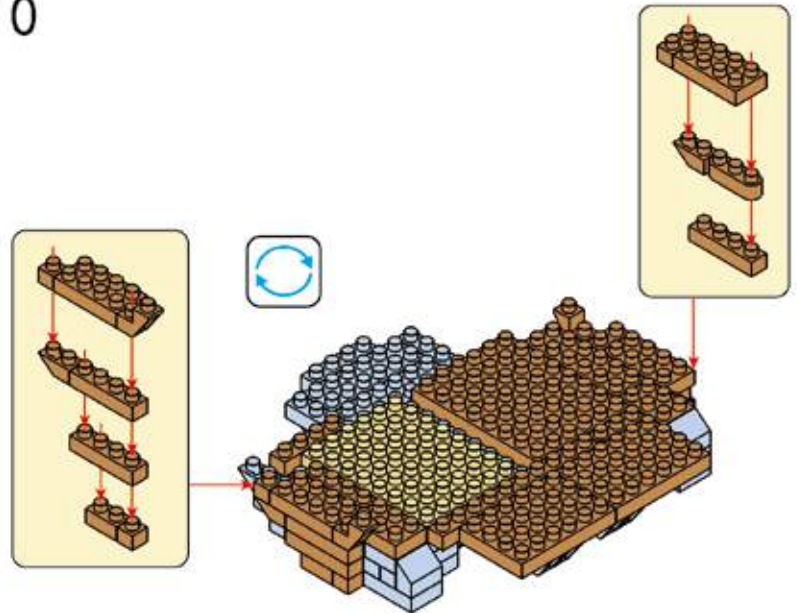
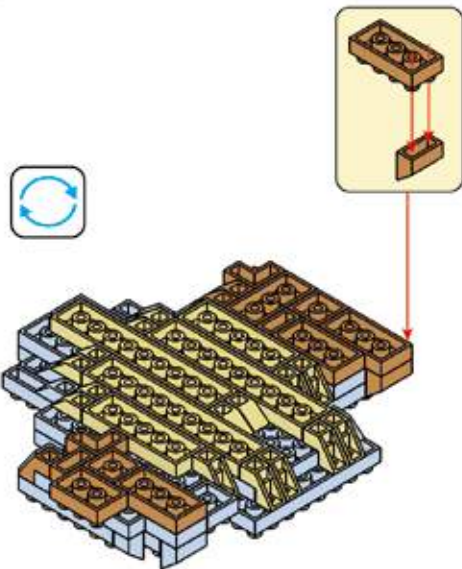

11

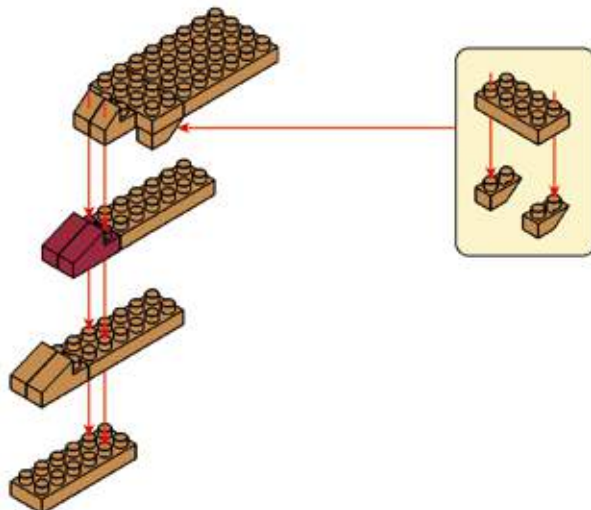

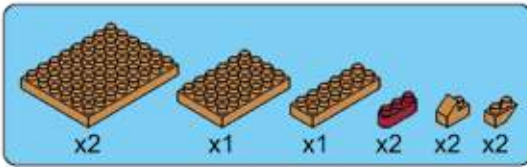

17

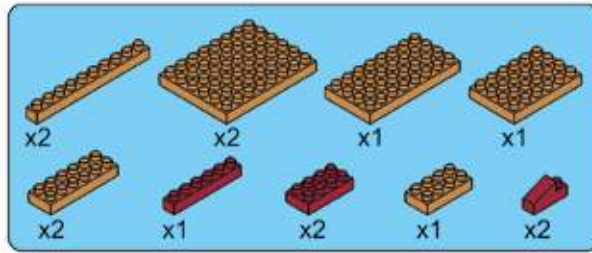
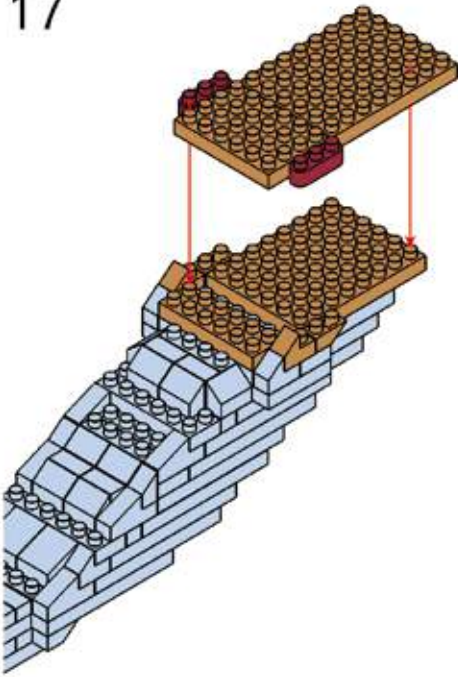

18

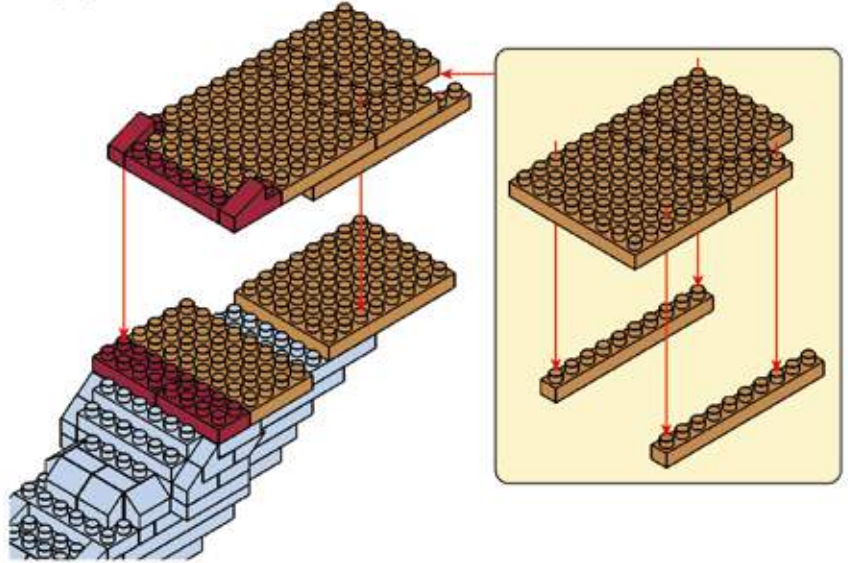

19

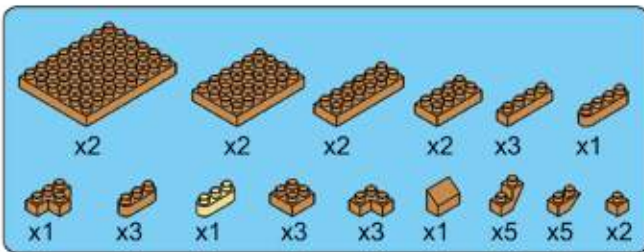
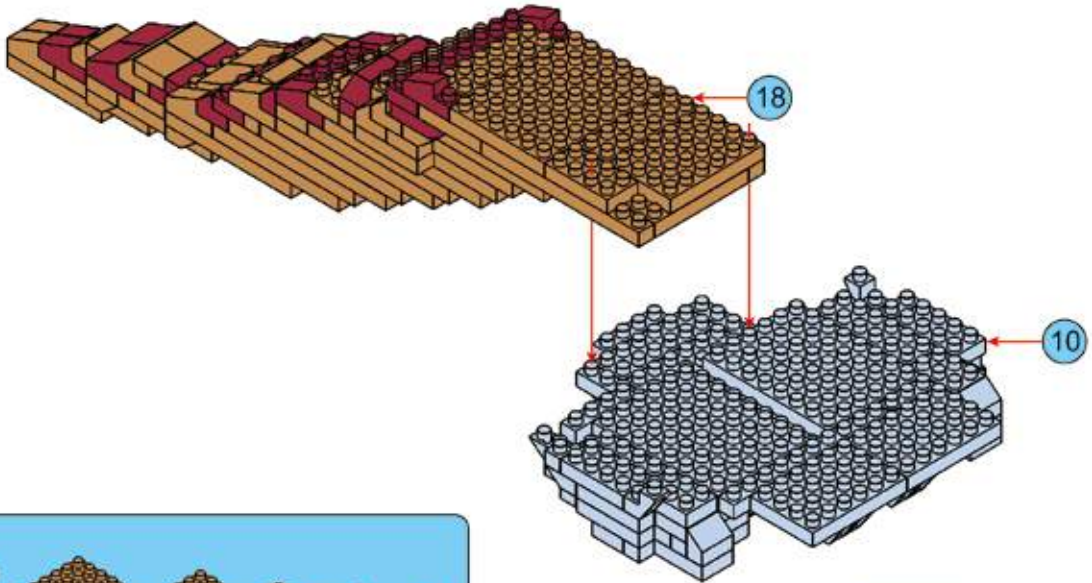

20

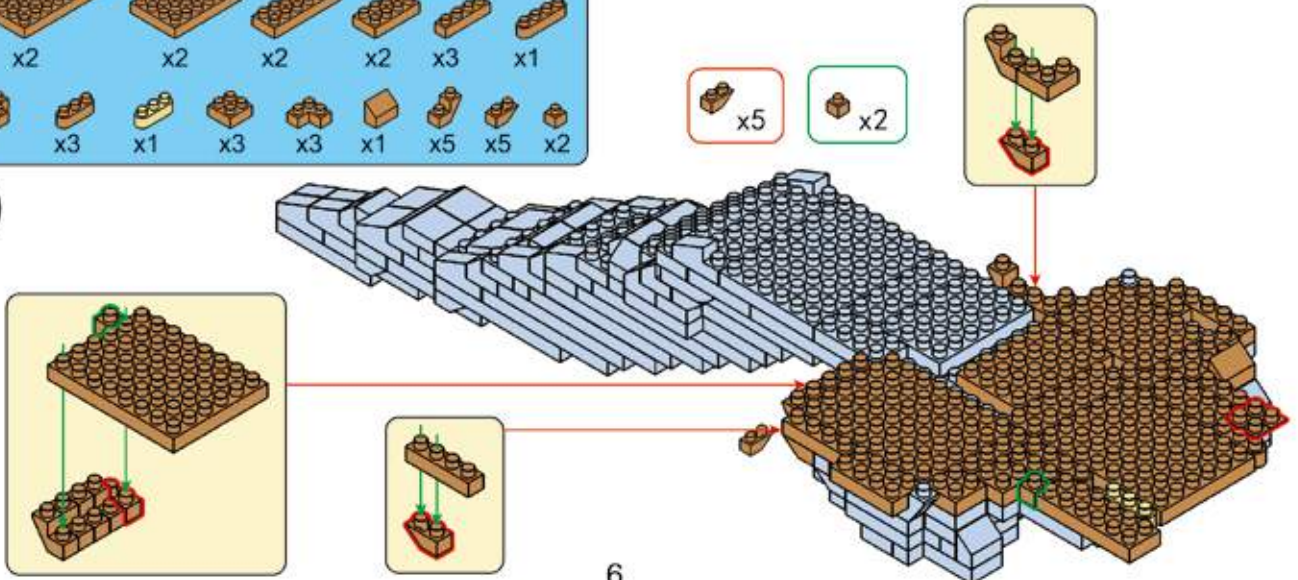

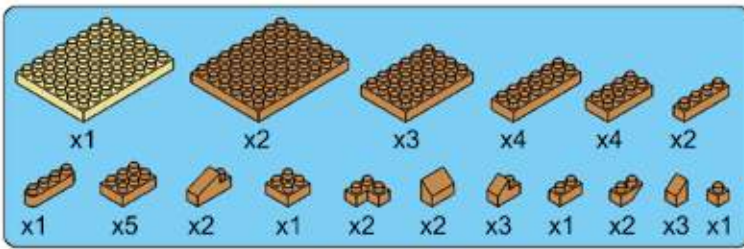

21

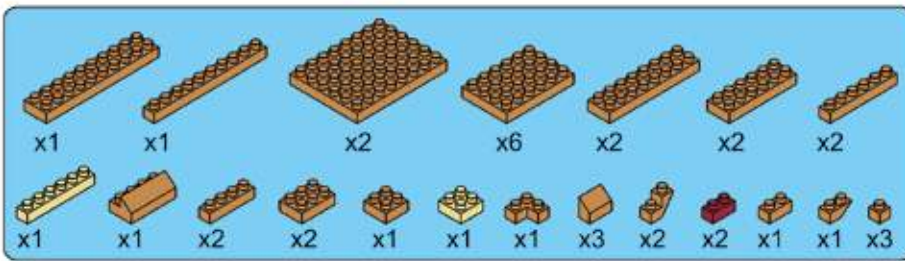
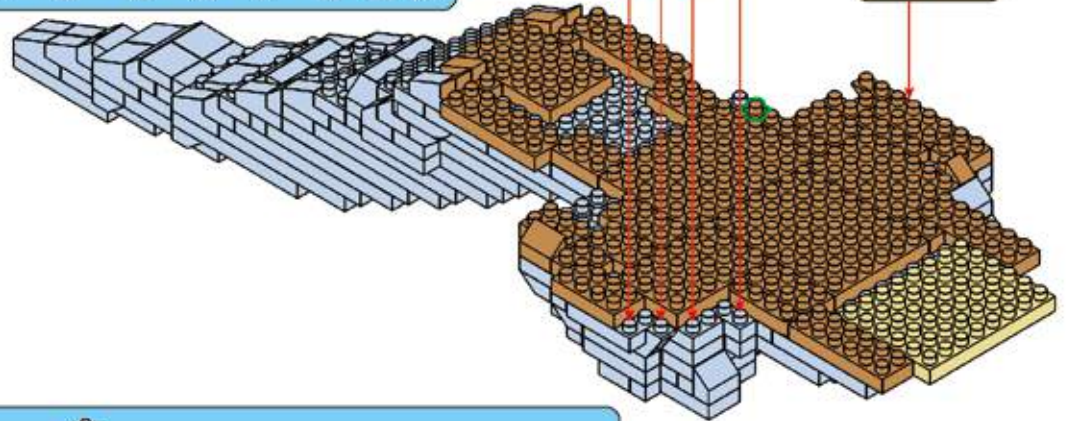

22

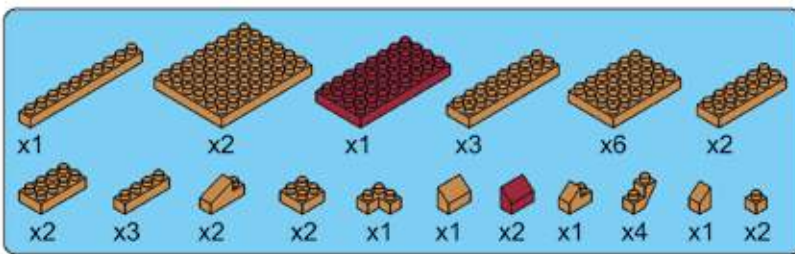
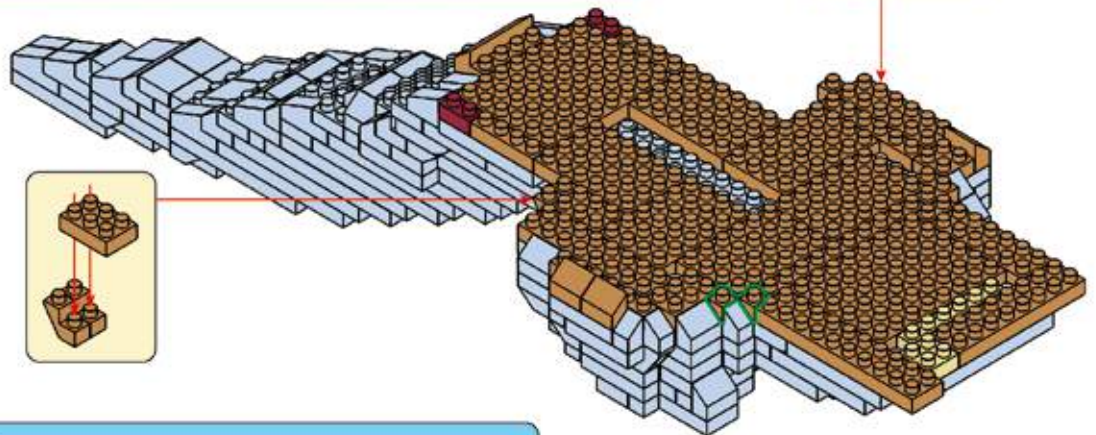

23

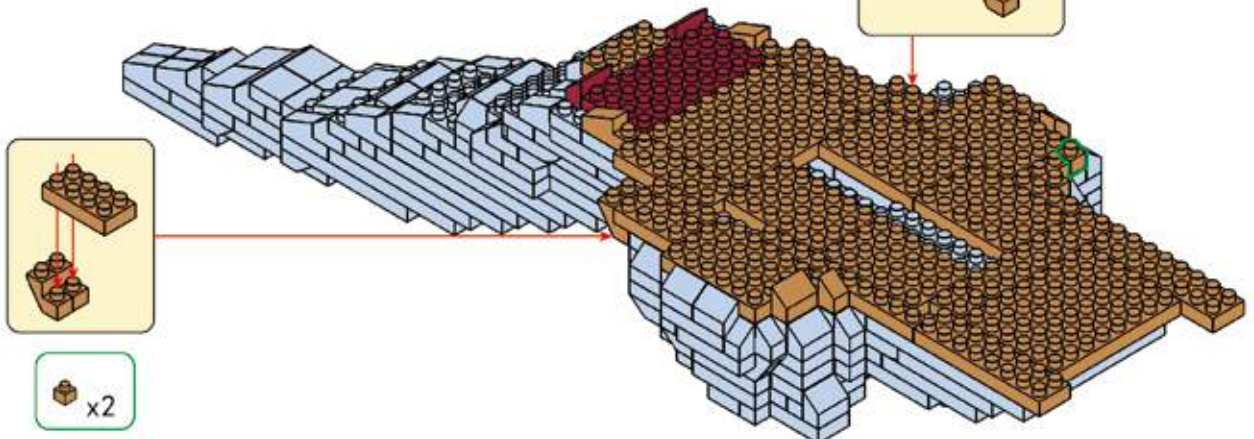

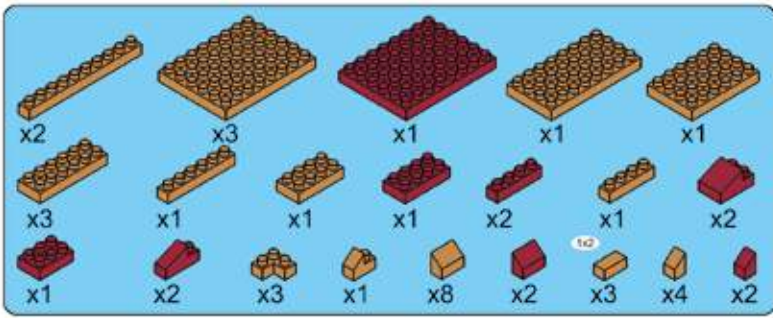

27

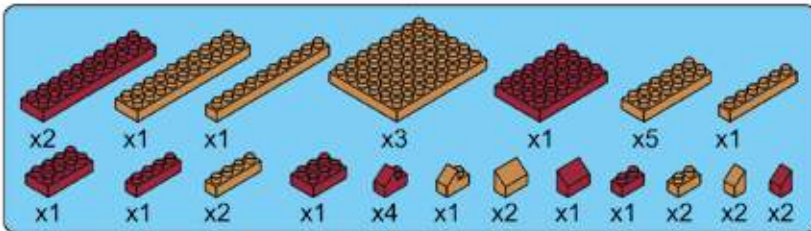
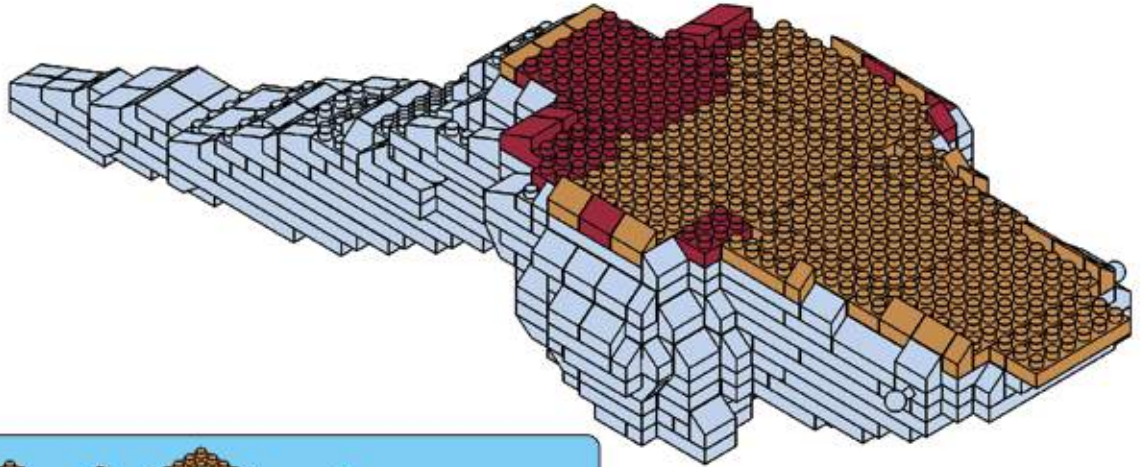

28

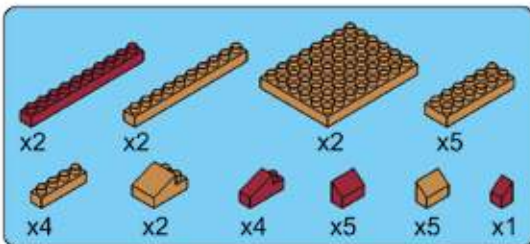
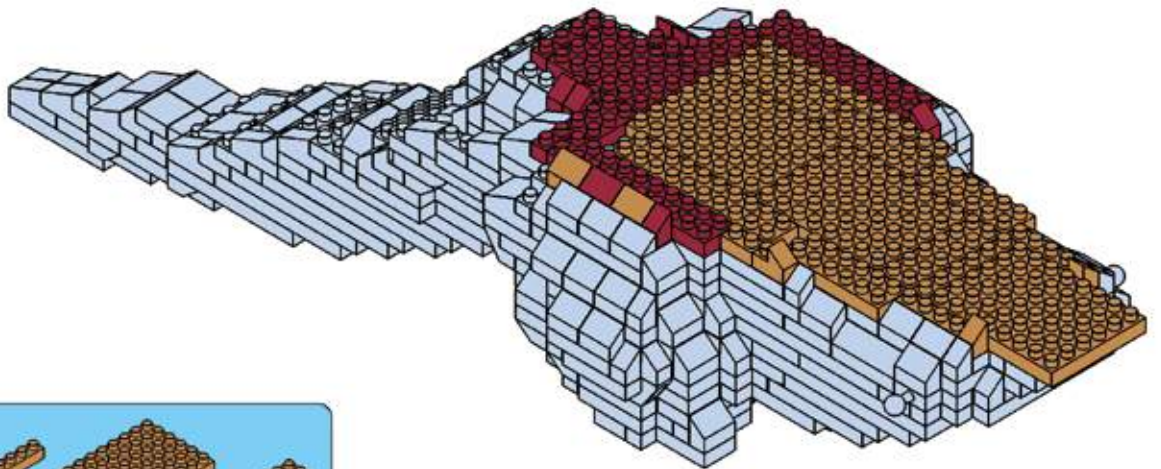

29

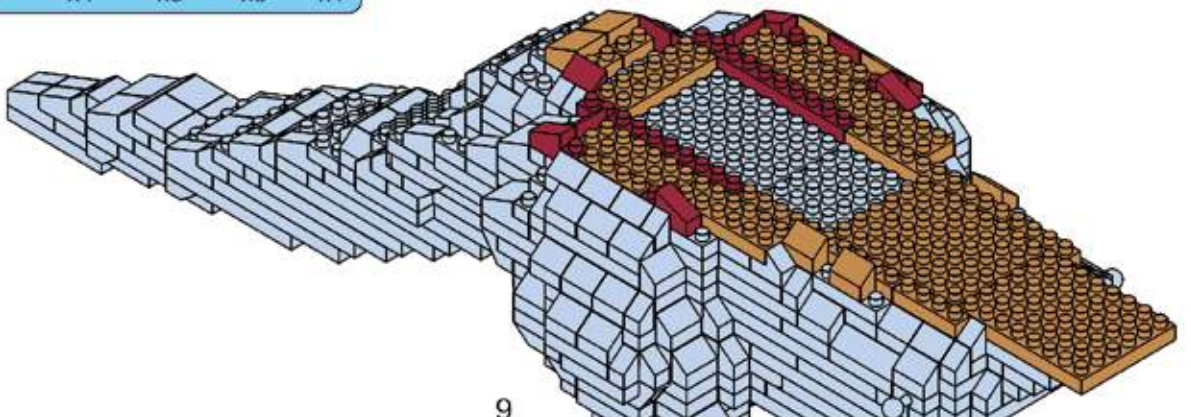

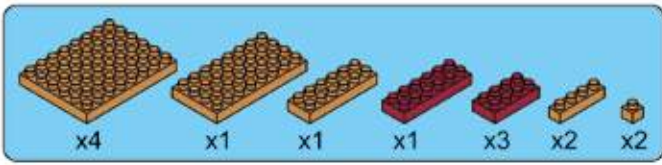

30

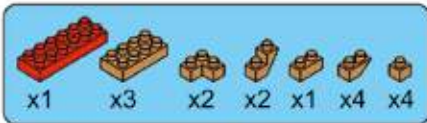
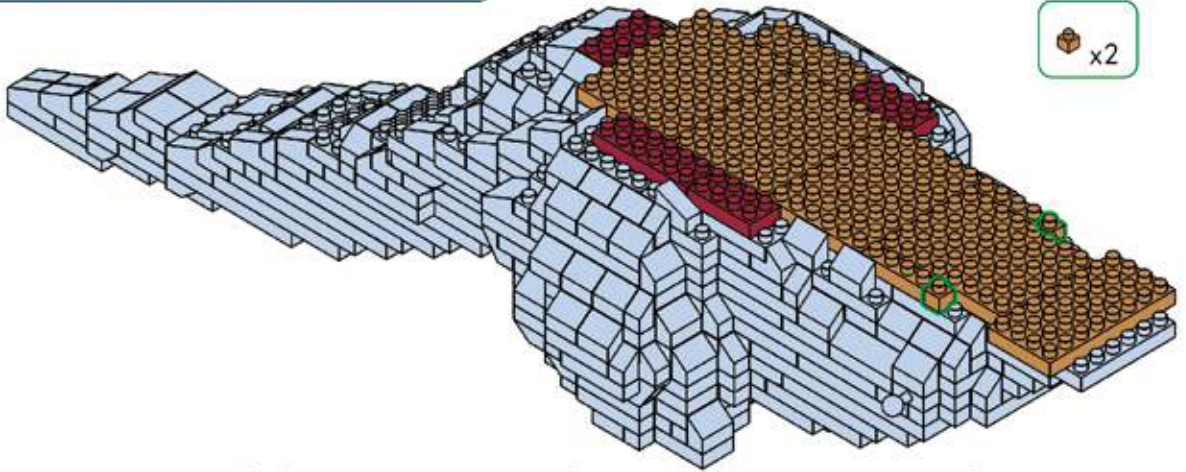

31

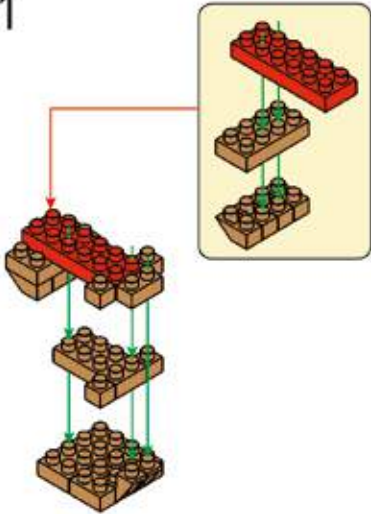

32

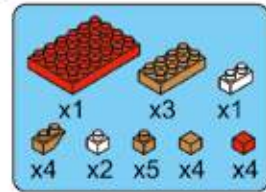
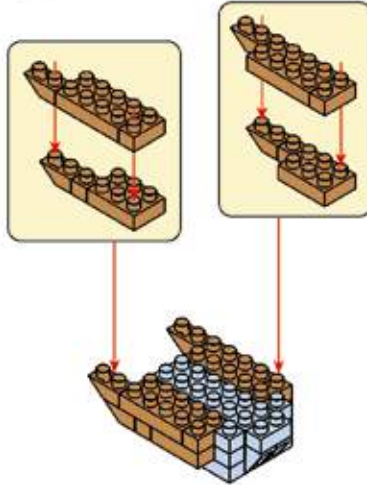

33

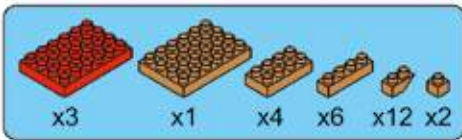
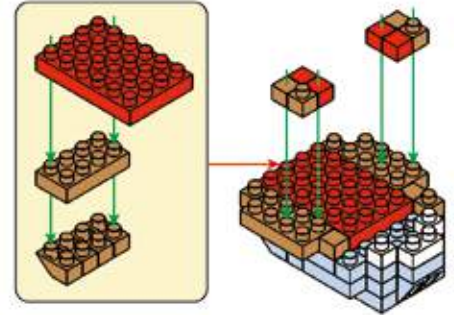

34

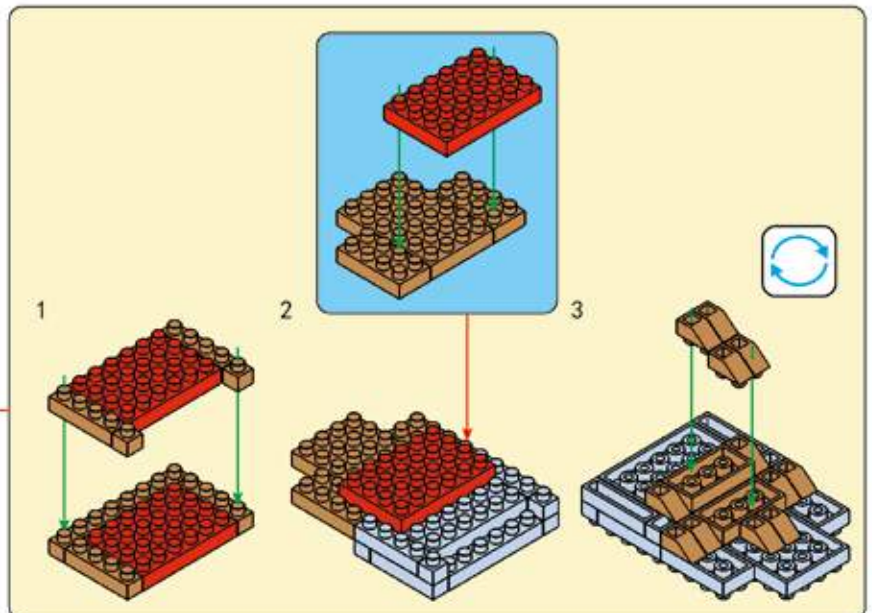
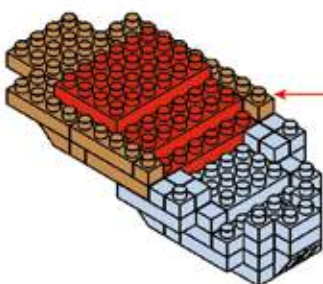

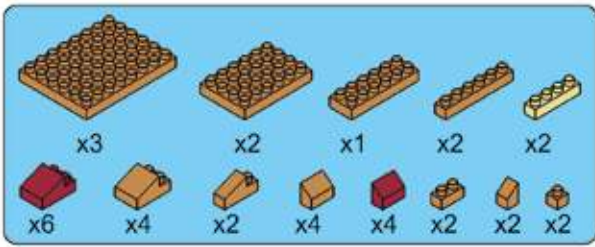

40

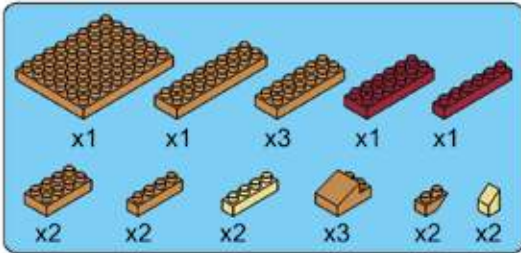
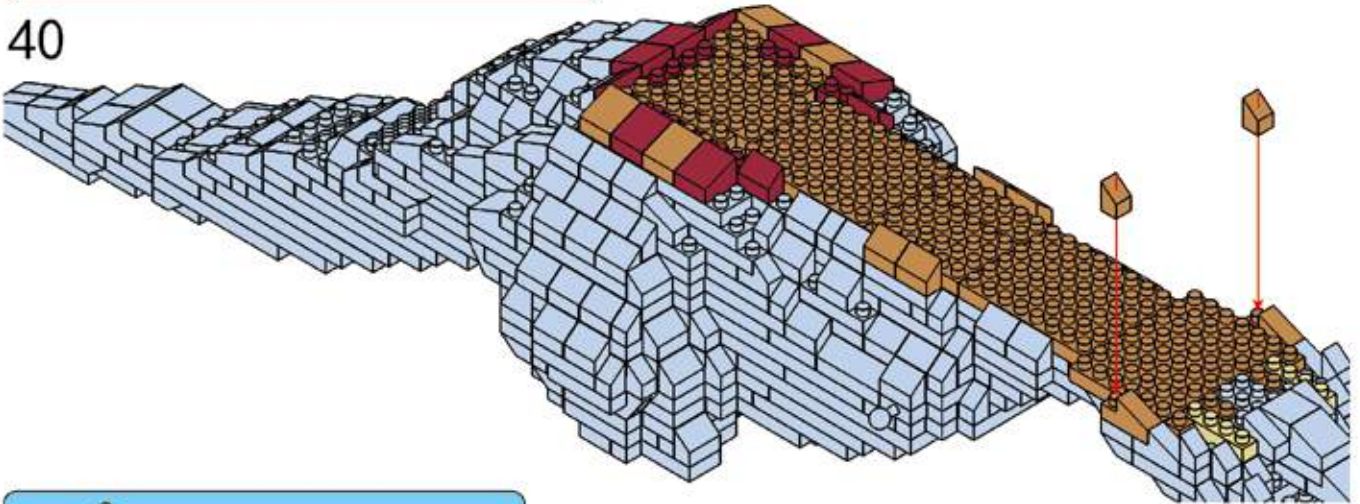

41

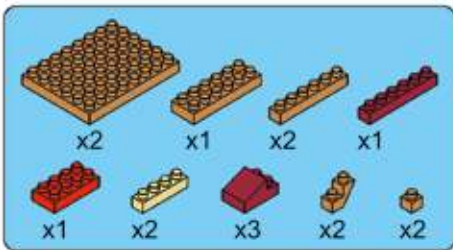
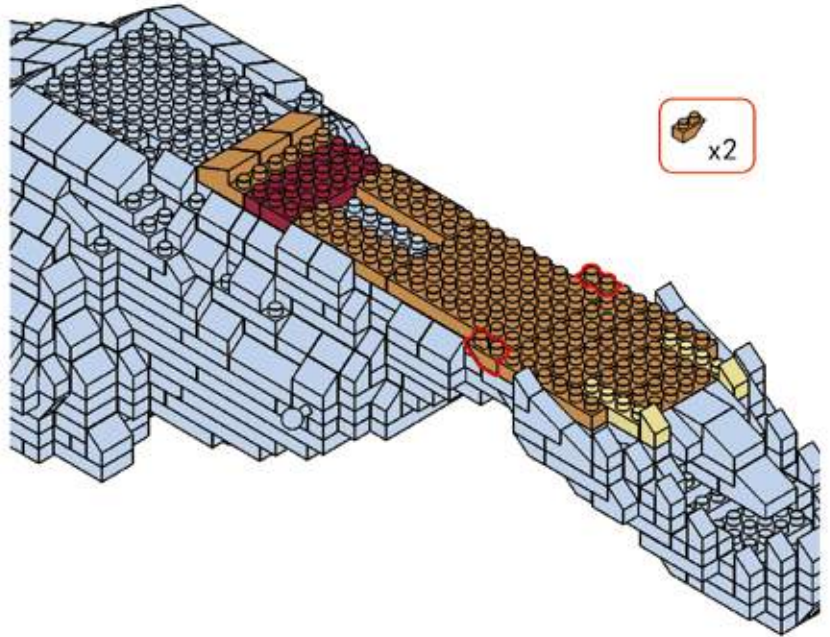

42

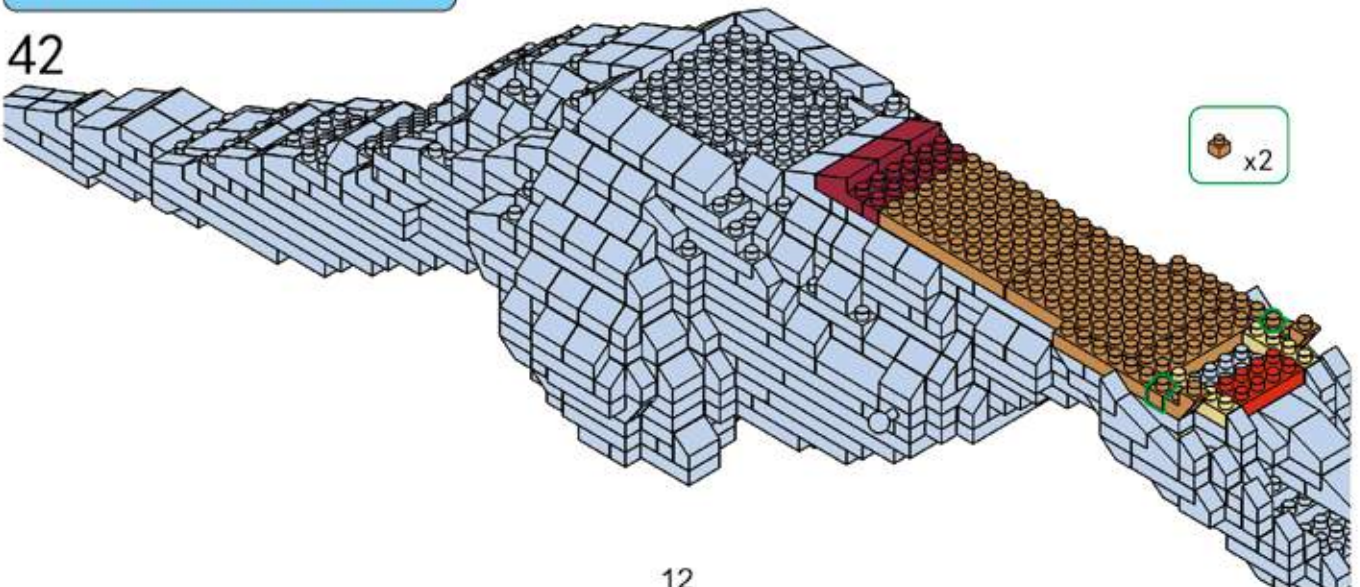

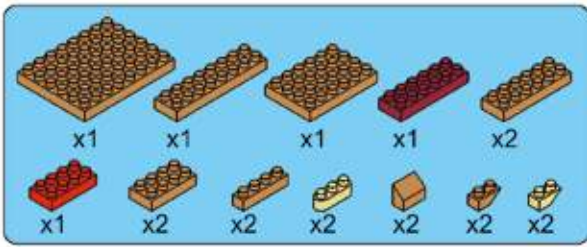

43

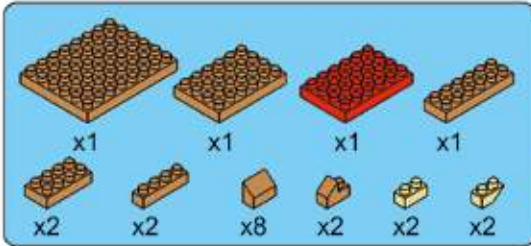
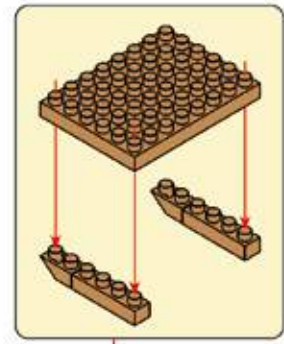
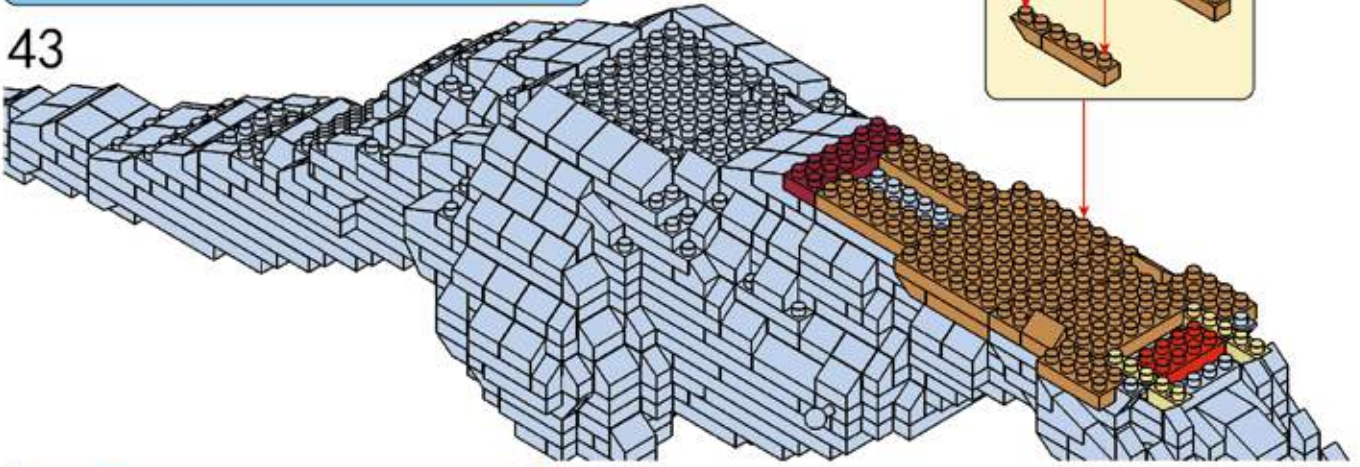

44

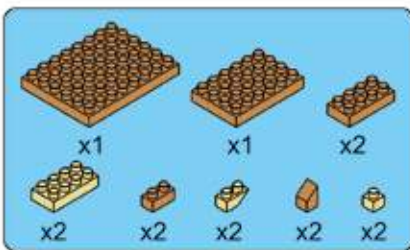
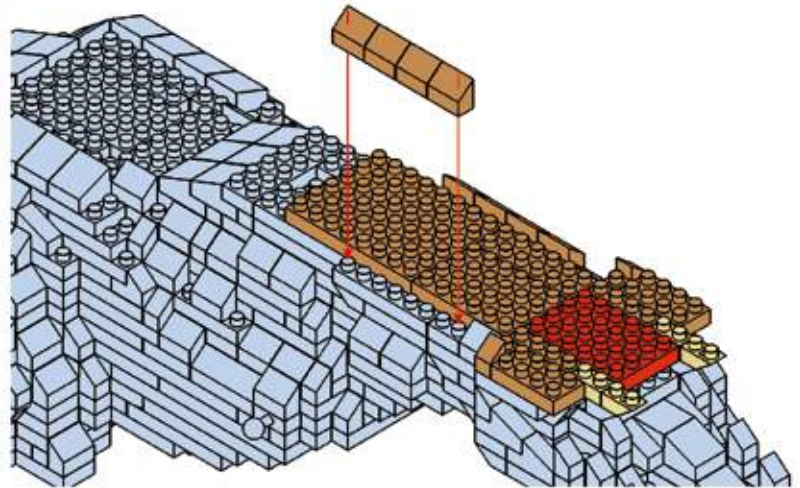

45

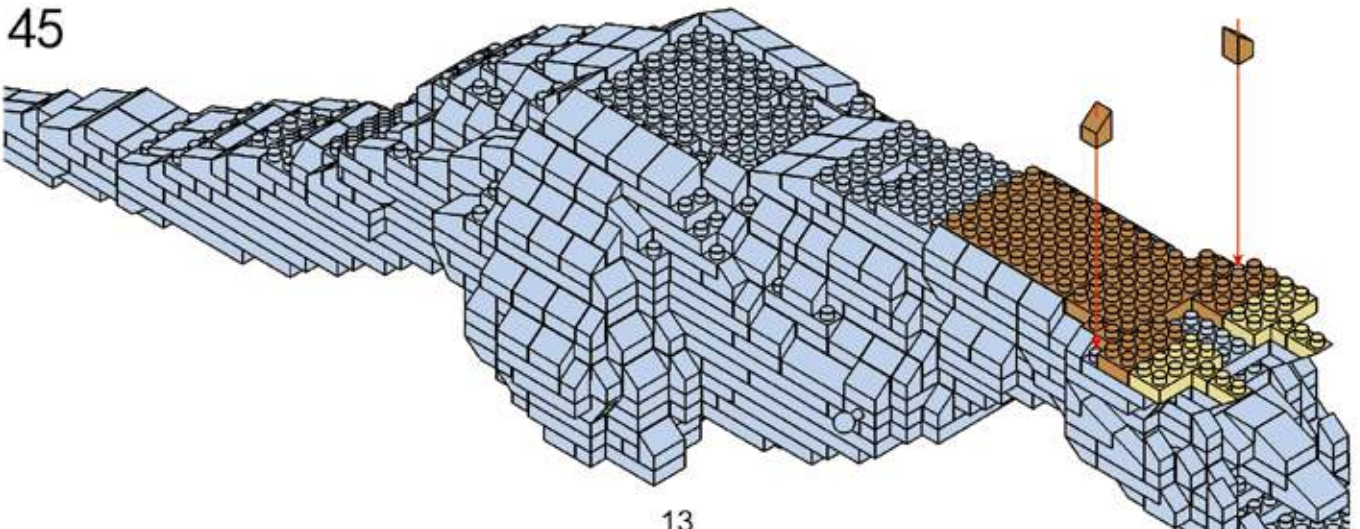

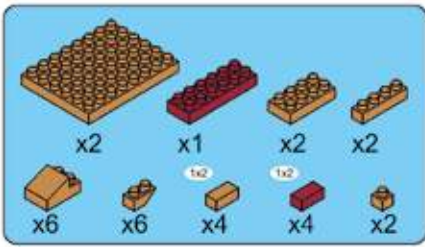

46

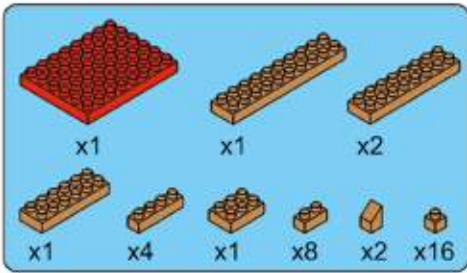
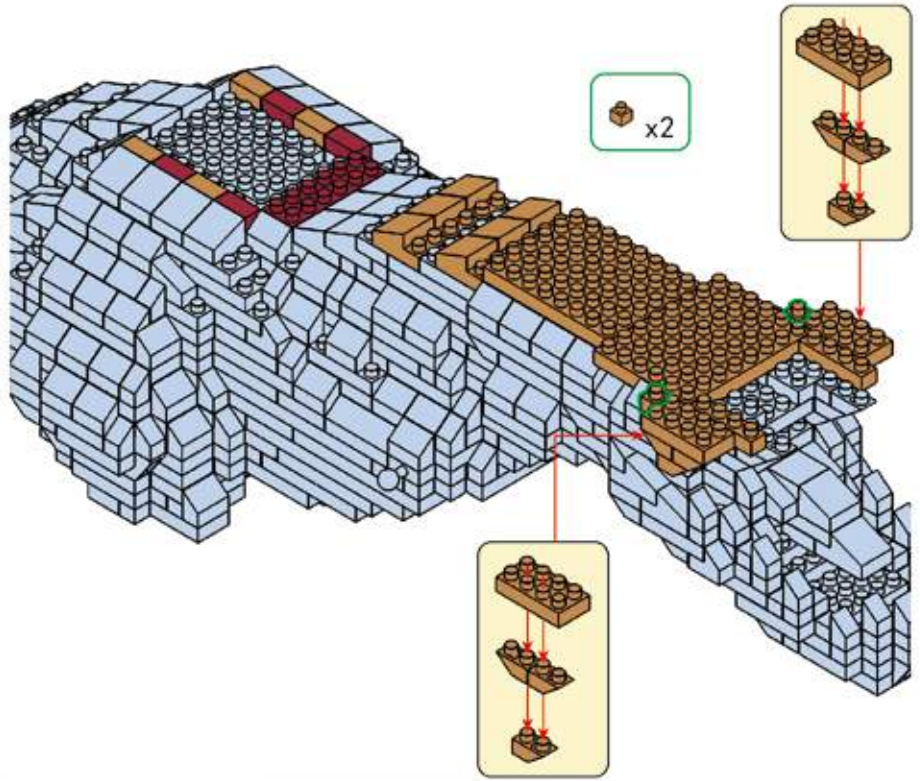

47

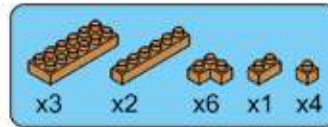
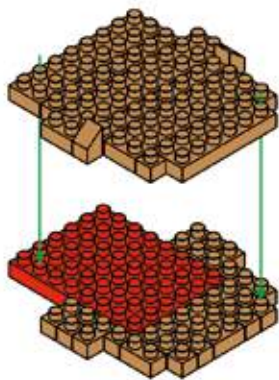

48

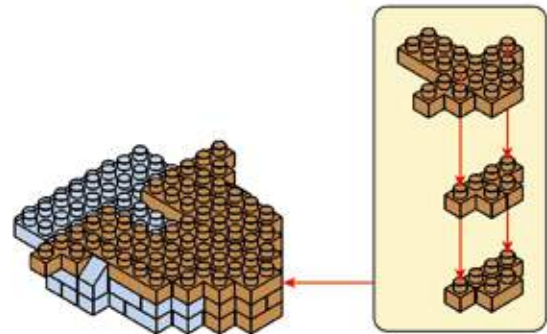

49

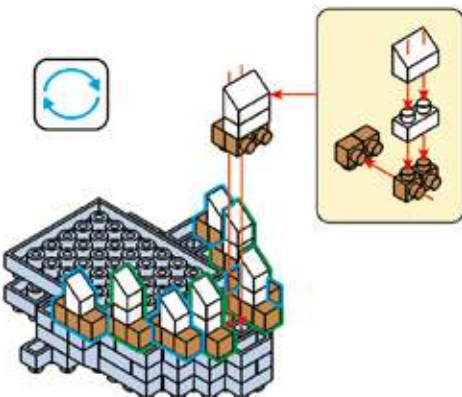

50

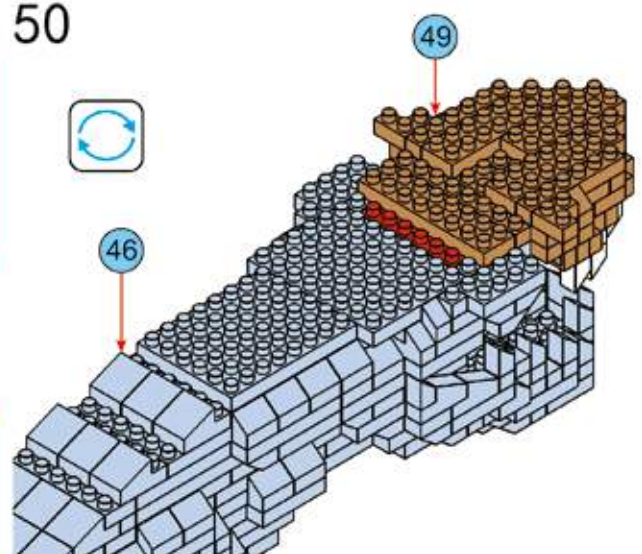
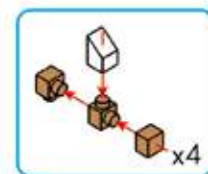
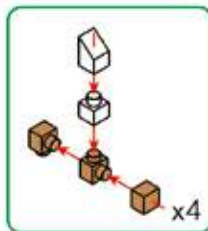

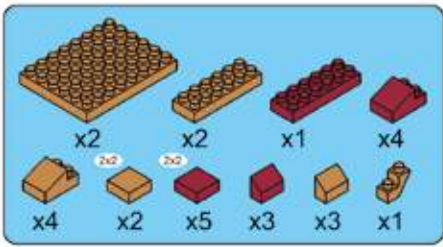

51

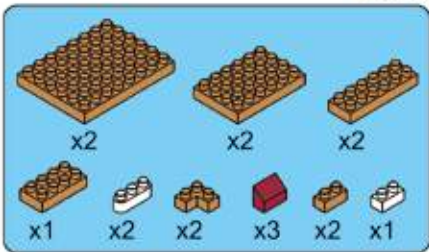
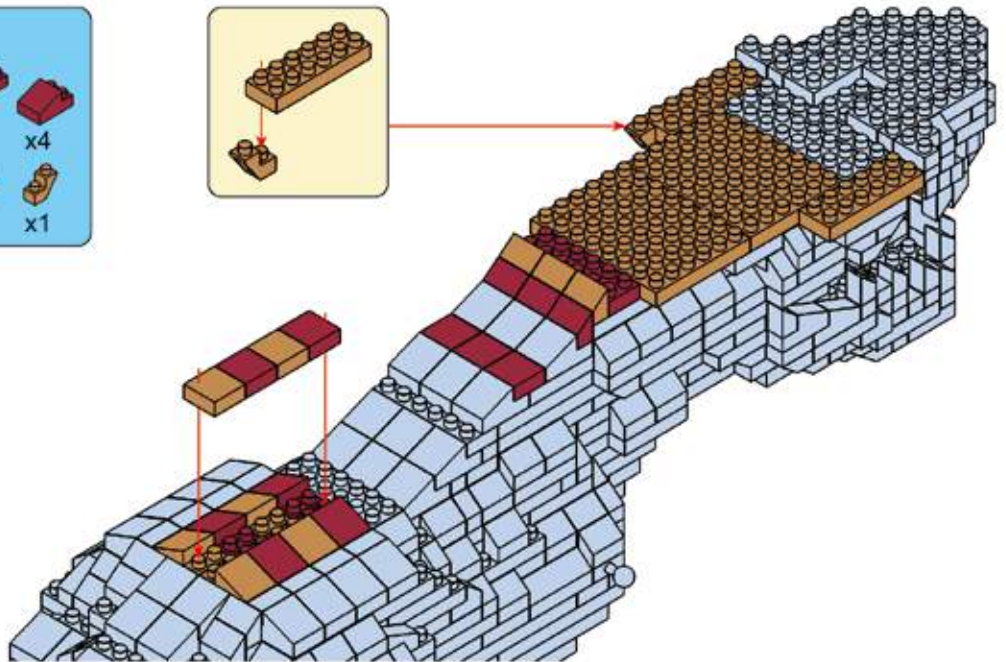

52

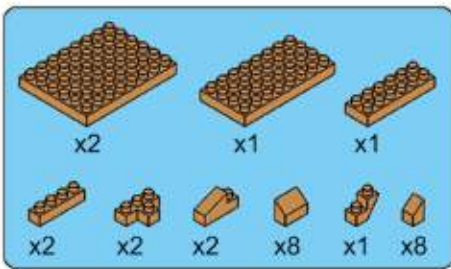
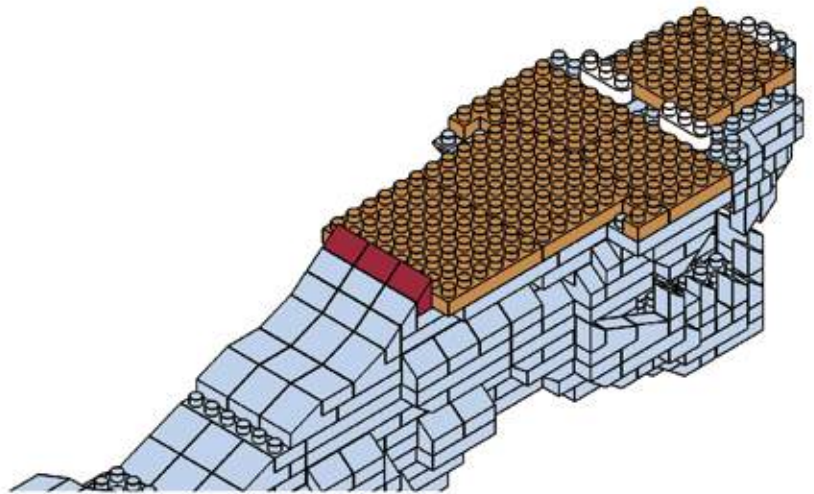

53

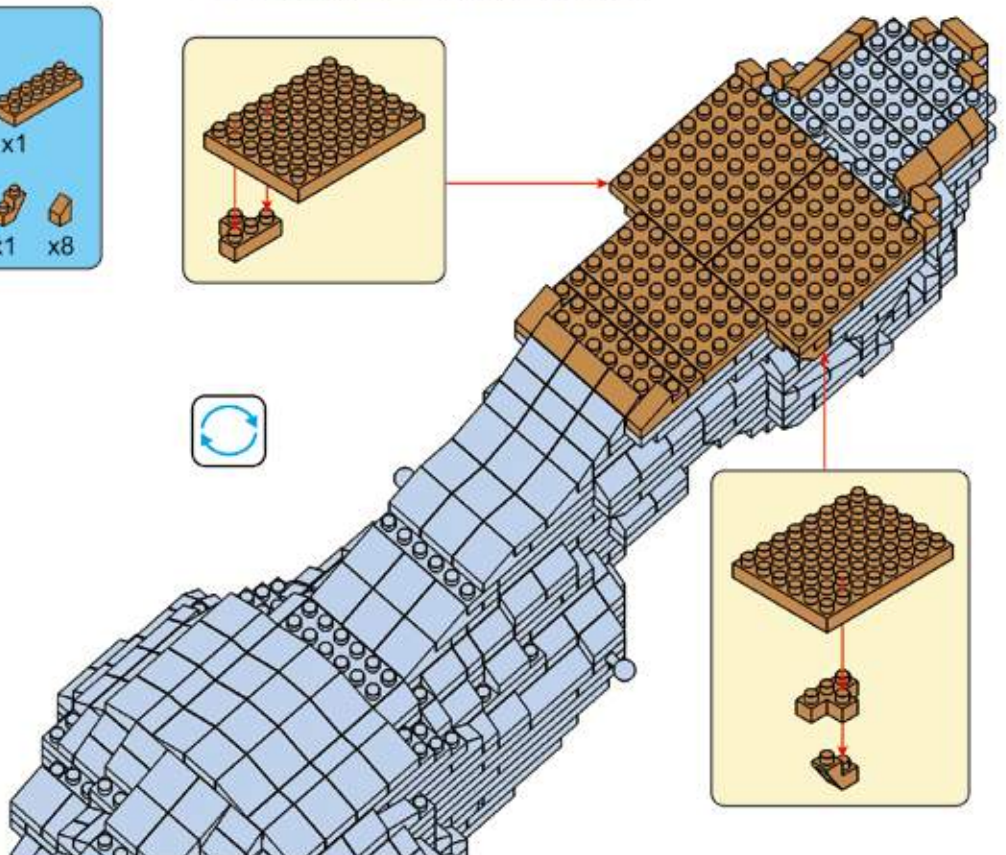

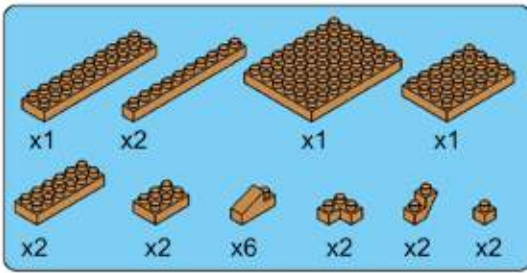

54

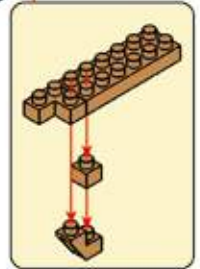
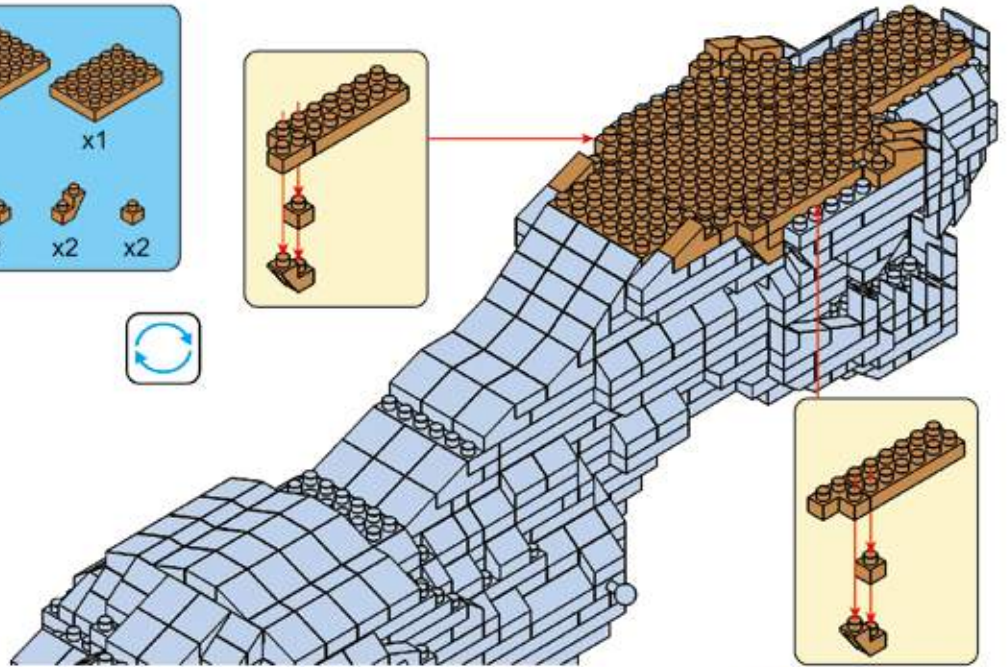
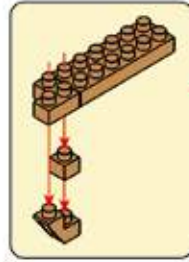

55

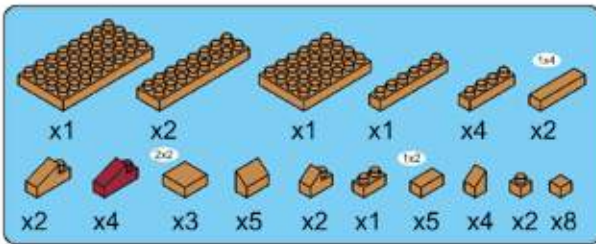
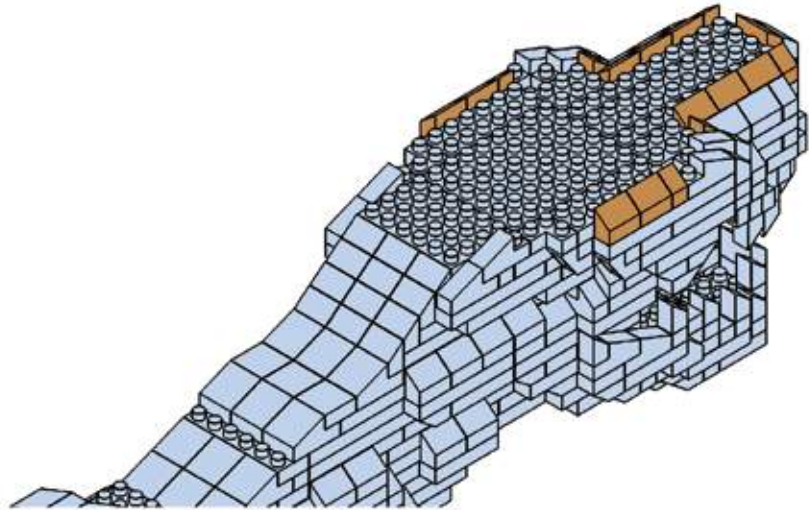

56

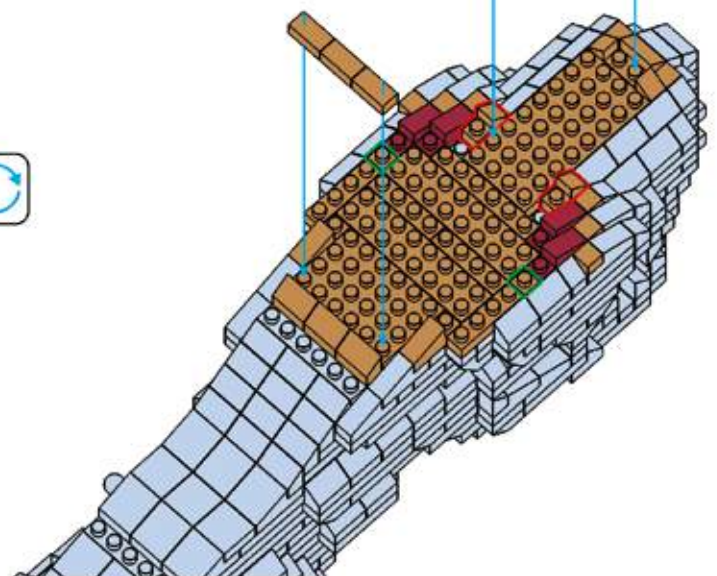
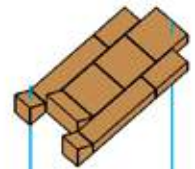
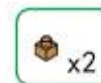

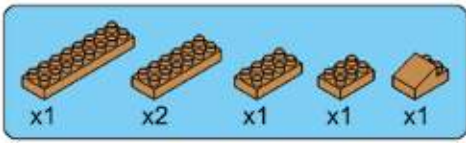

57

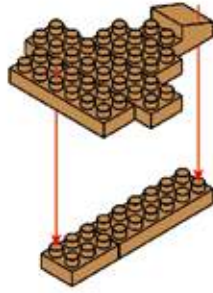

58

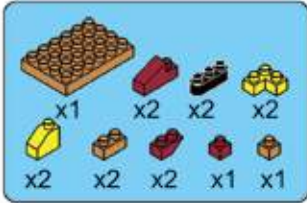
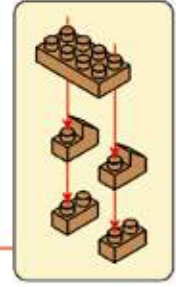

59

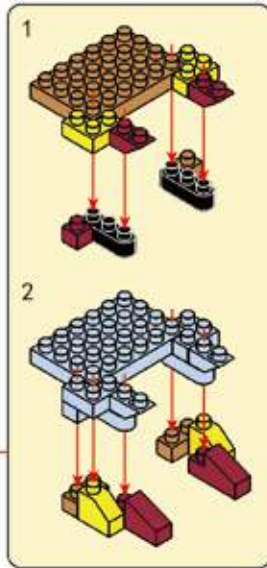

60

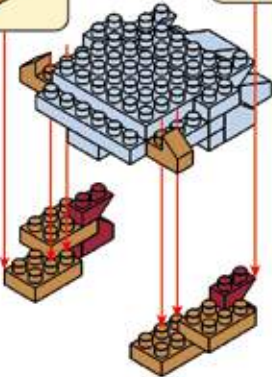
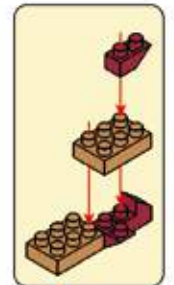
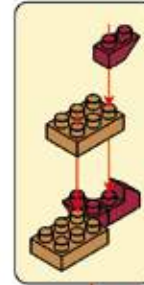

61

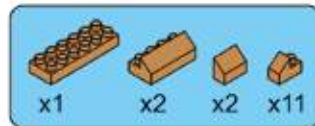

62



63

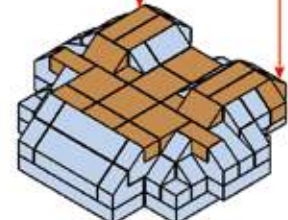
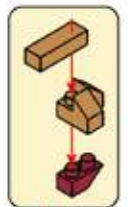
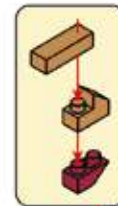
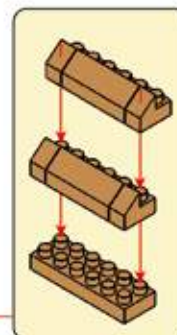
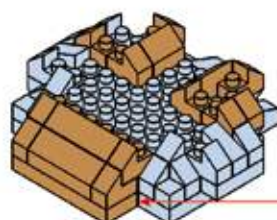

64

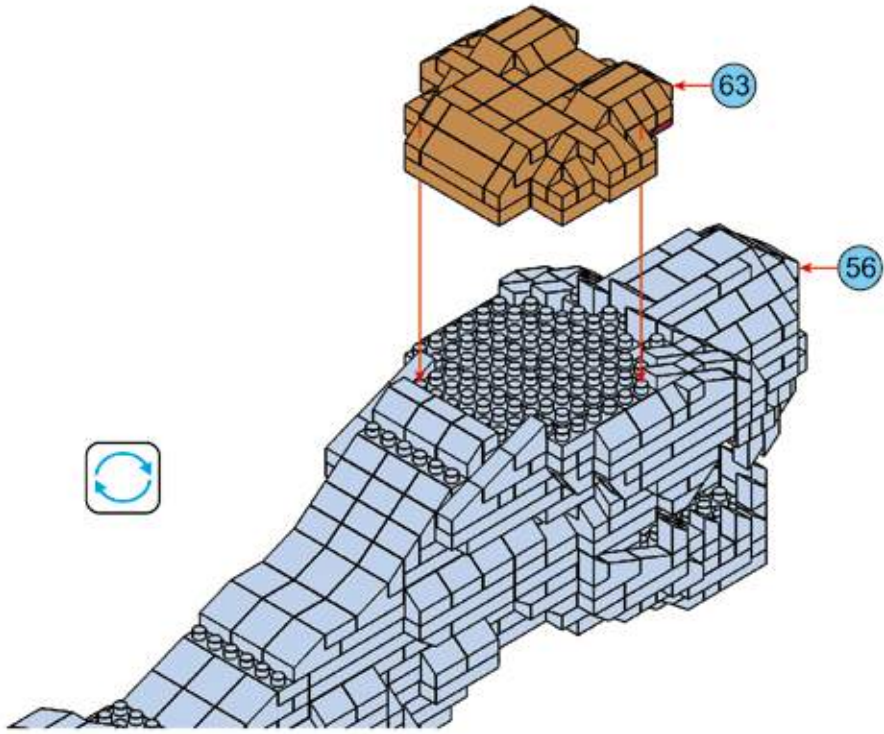

65

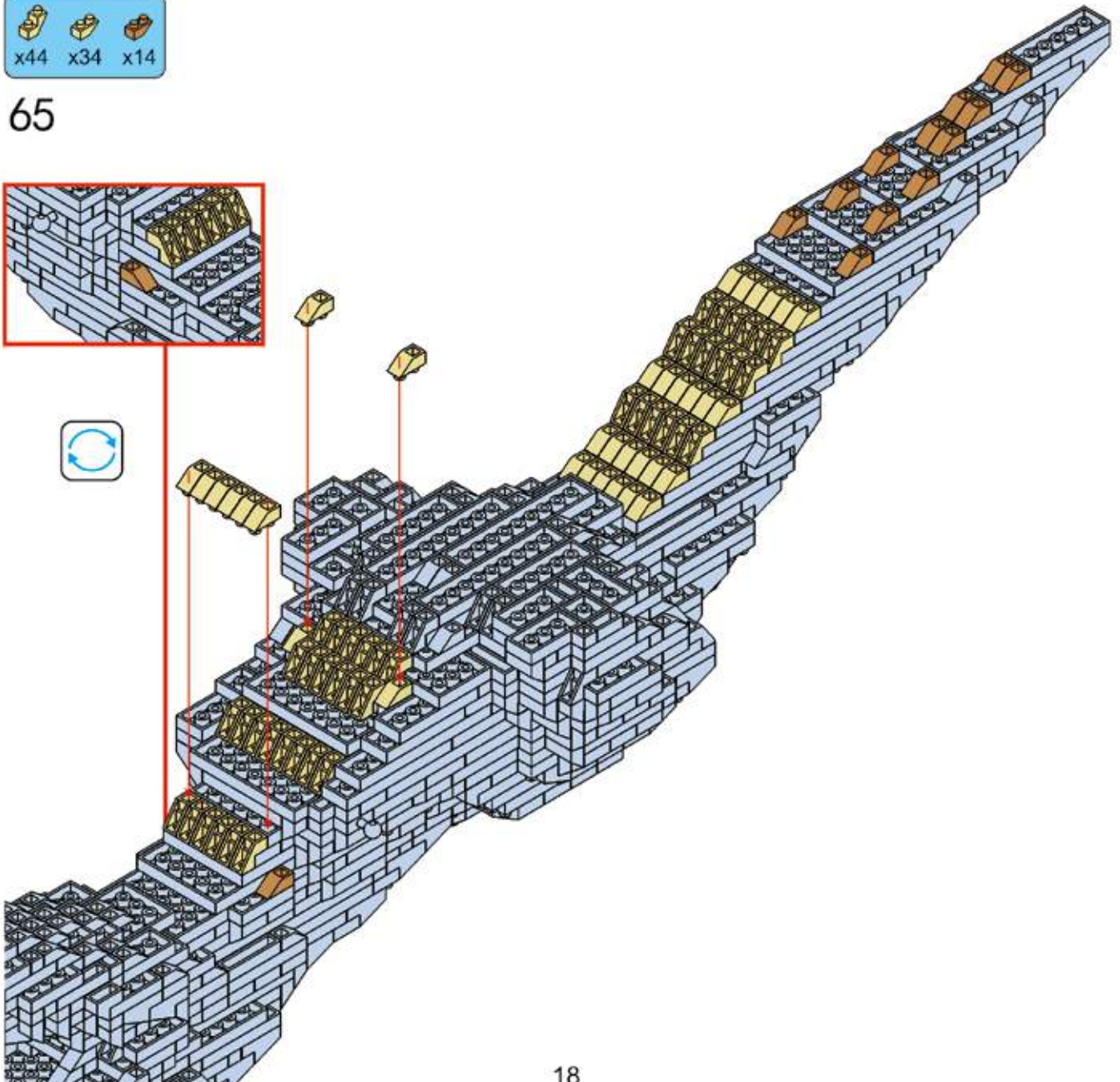

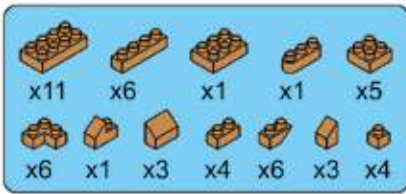

66

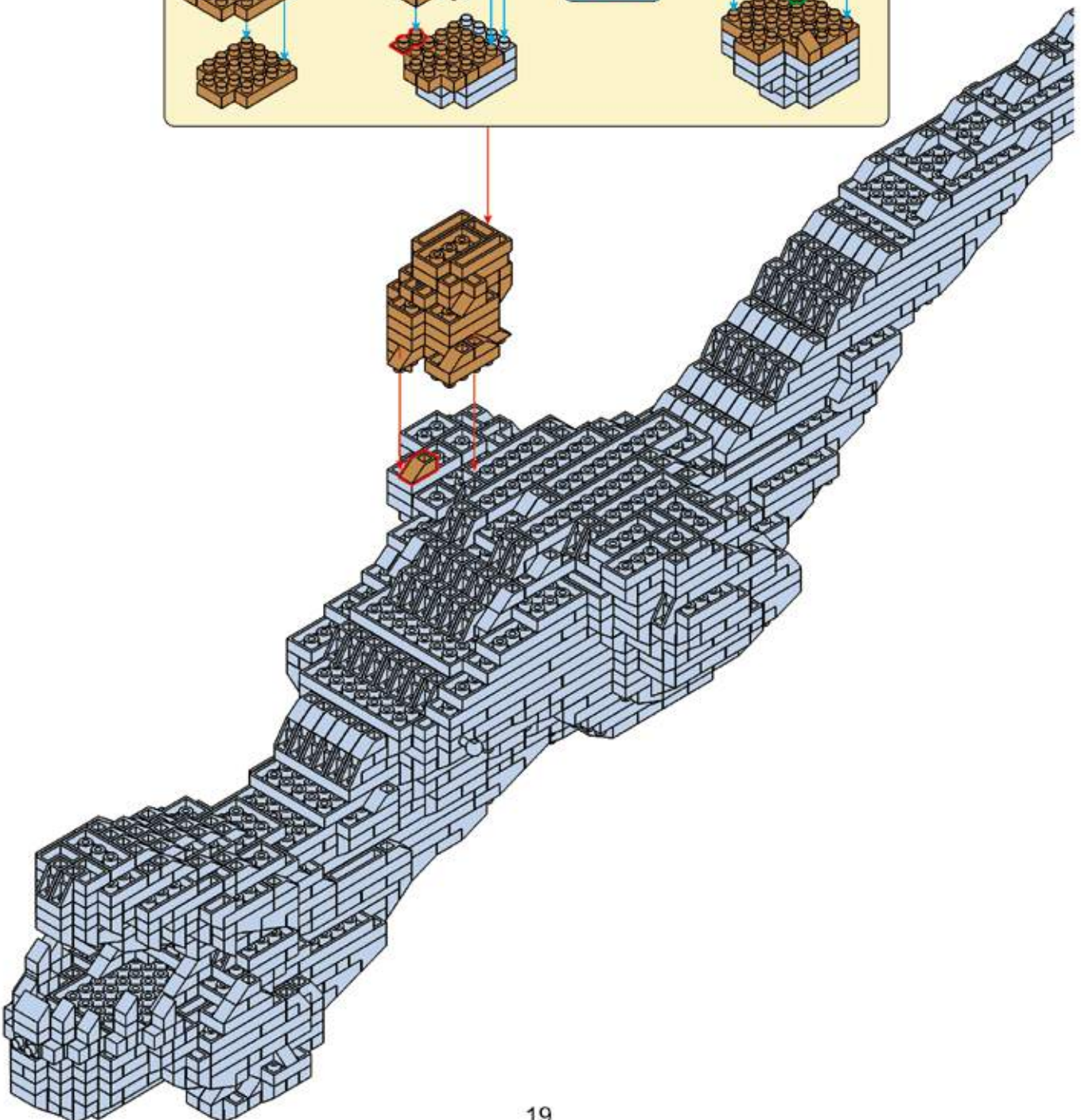
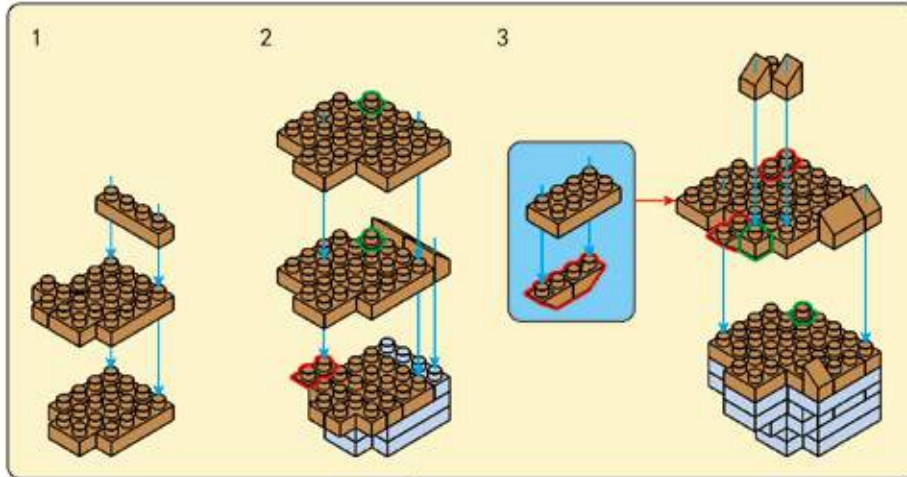

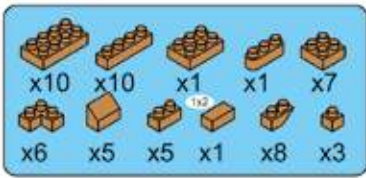

67

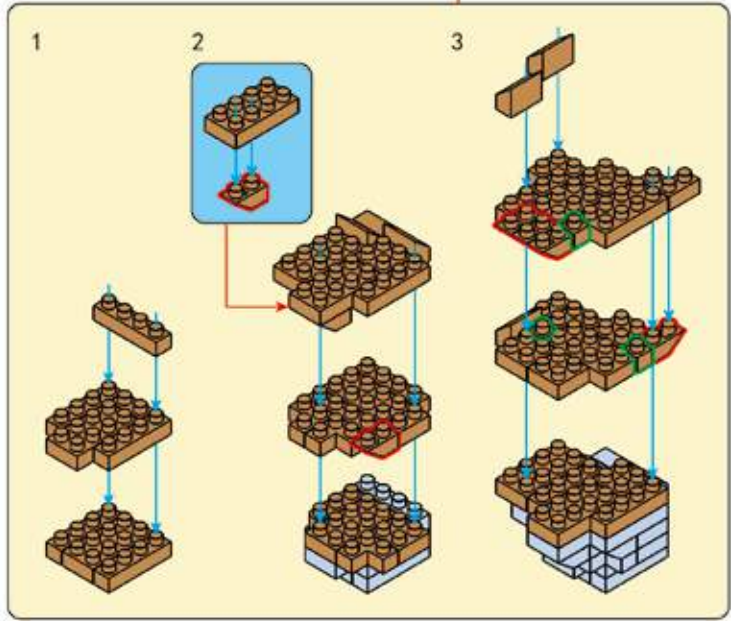
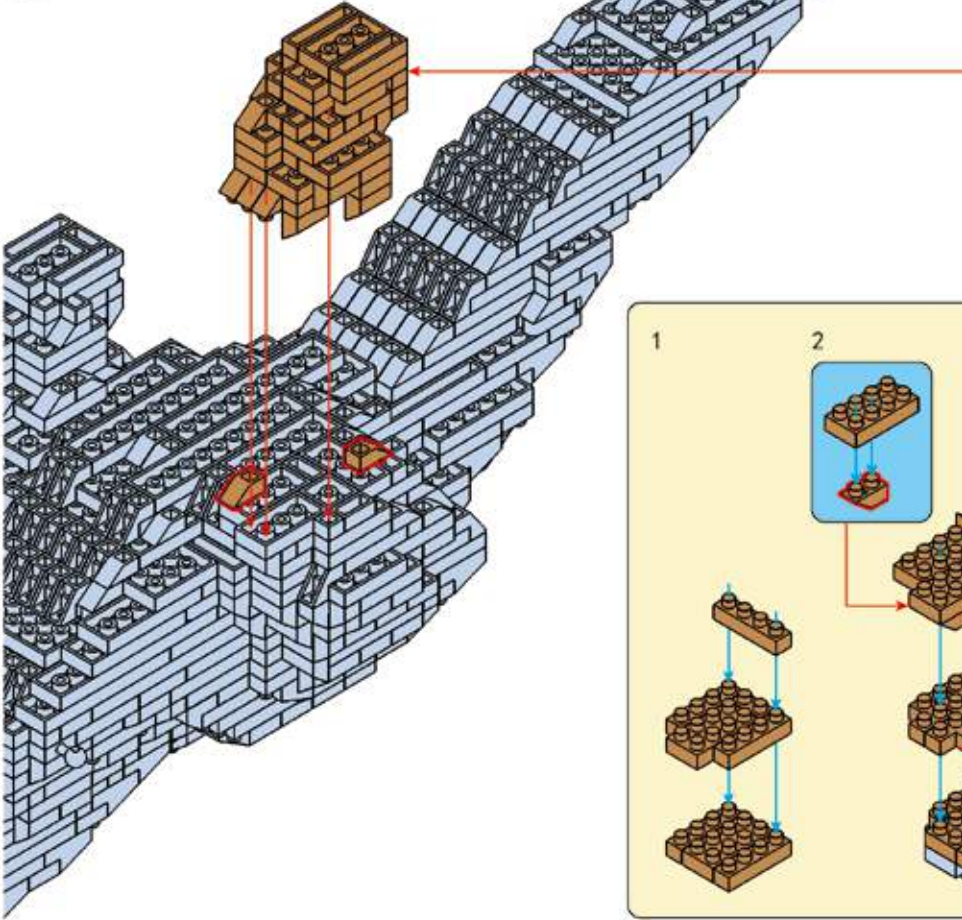
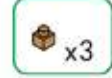

68

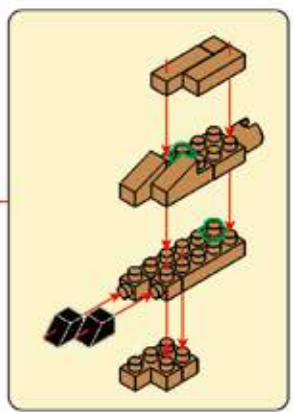
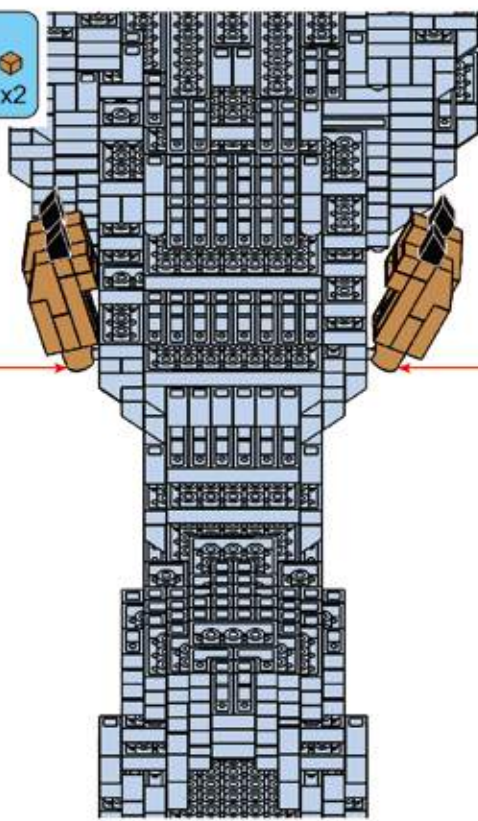
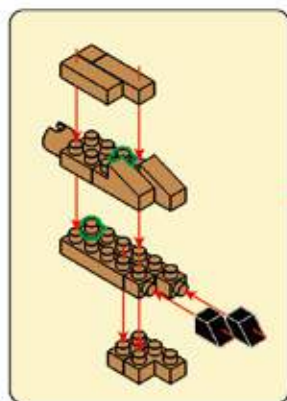

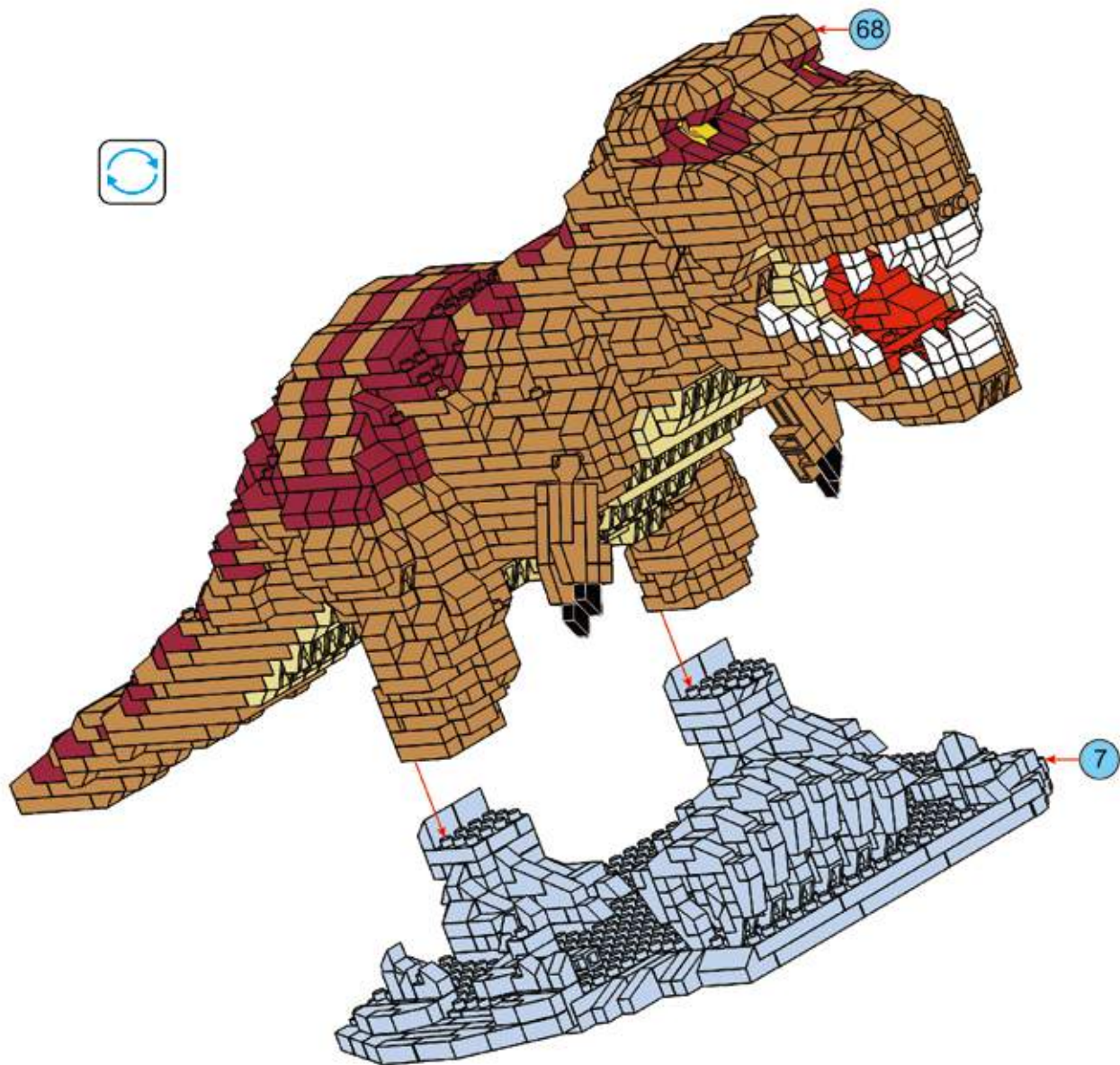

70



x2



71

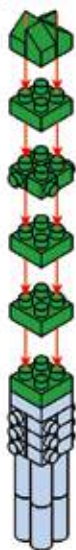

x2

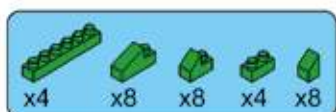

72

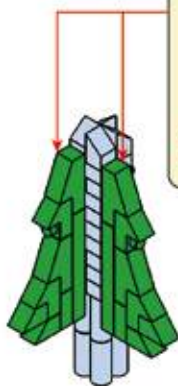

x2

21

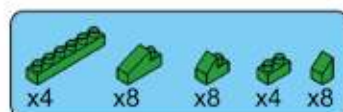

73

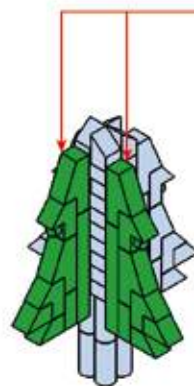

x2

x4

74

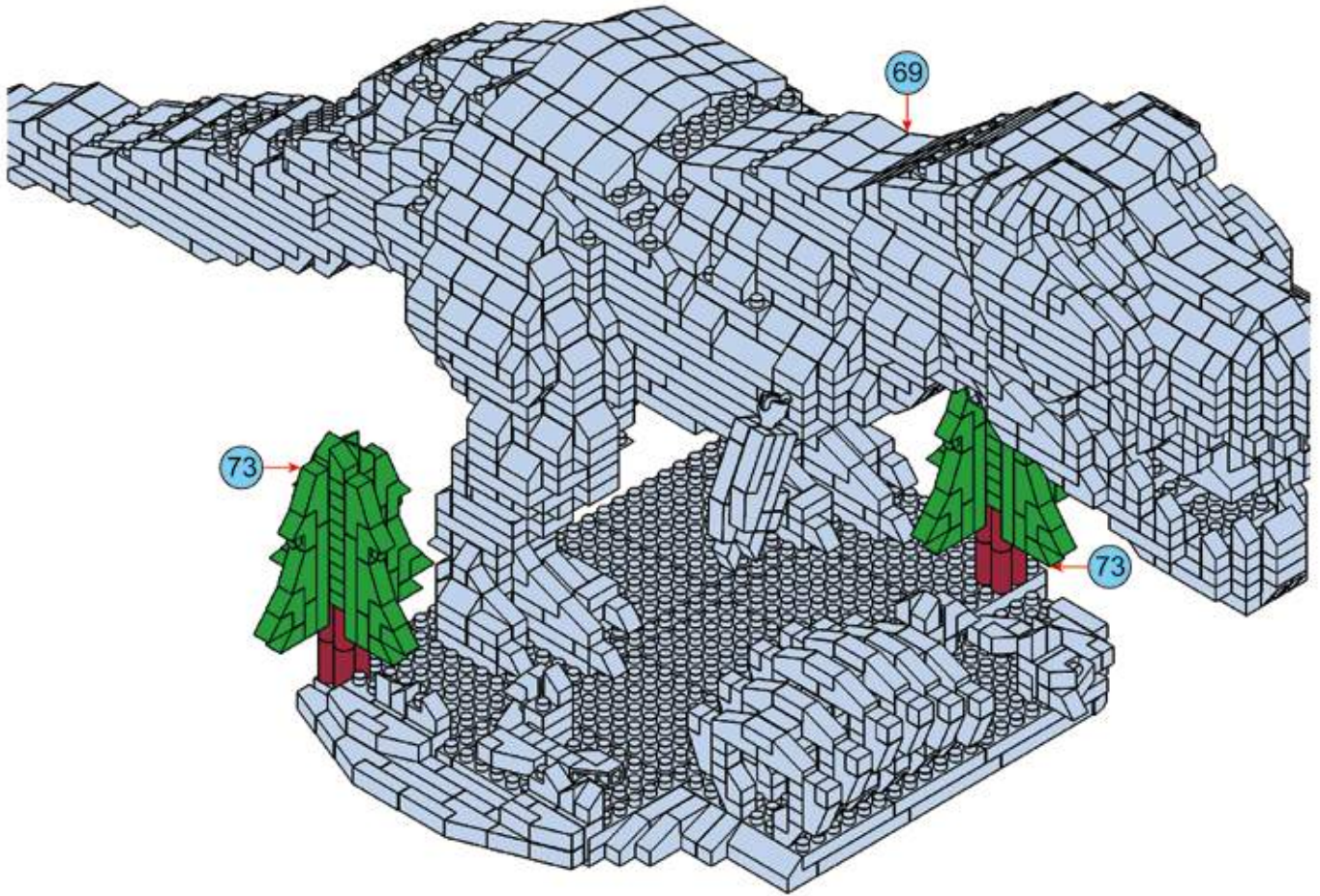

75

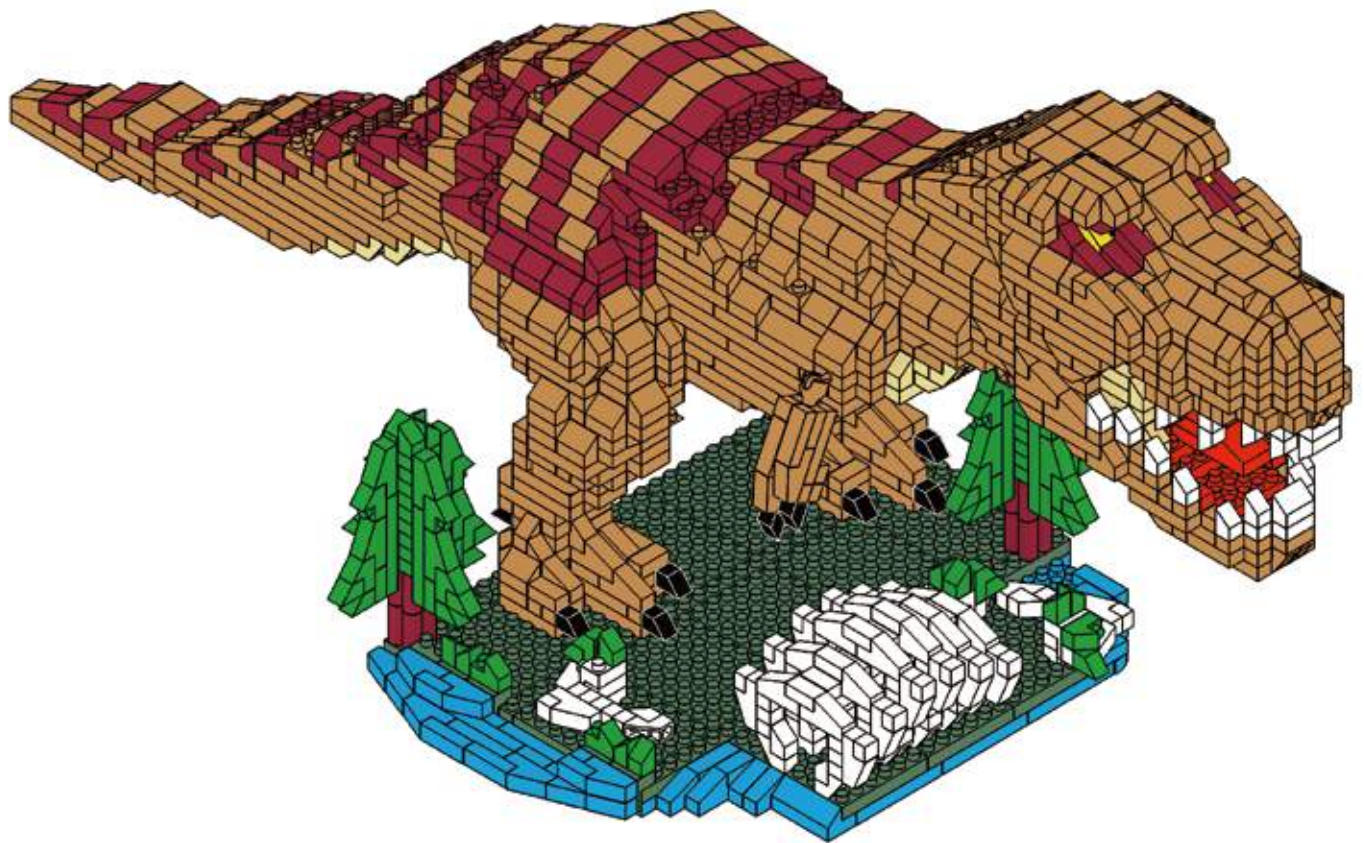

MINI BLOCK TYRANNOSAURUS REX



10+
YEARS

Difficulty index:

