

6+ YEARS

Instructions



113PCS

WARNING: CHOKING HAZARD - Small parts. Not for children under 3 years.

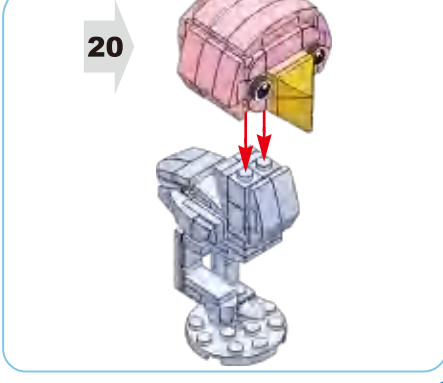
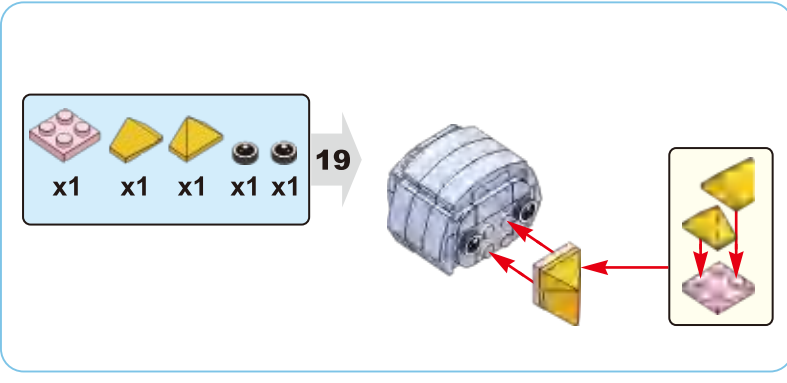
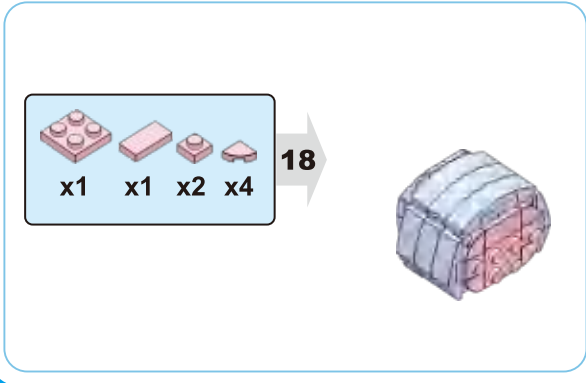
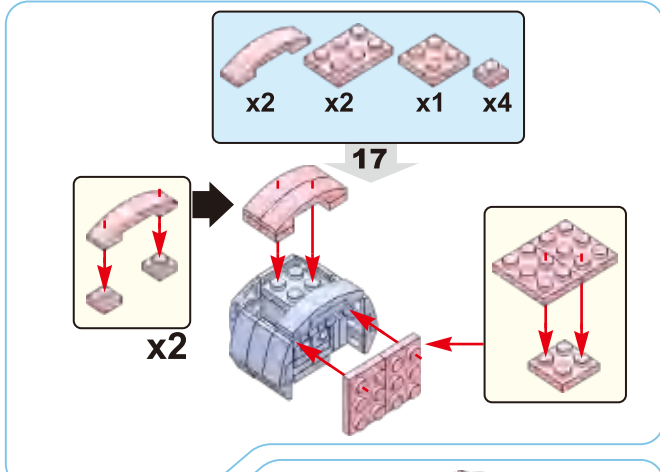
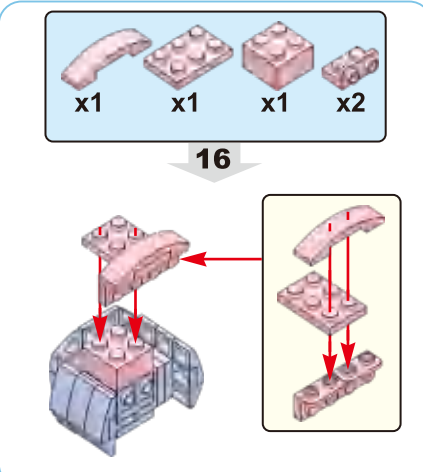
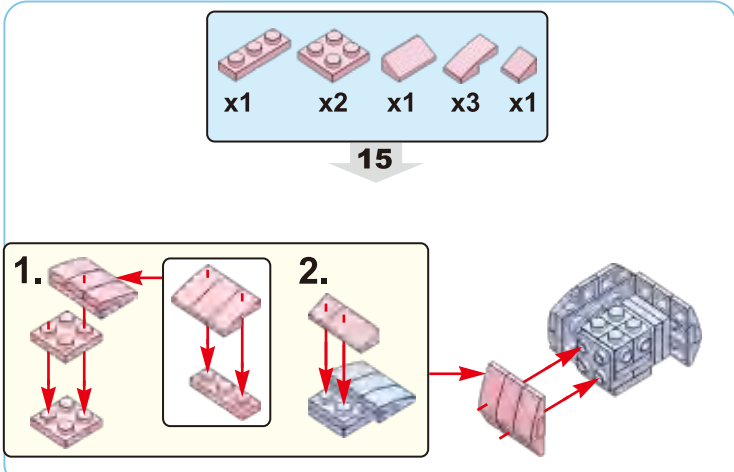
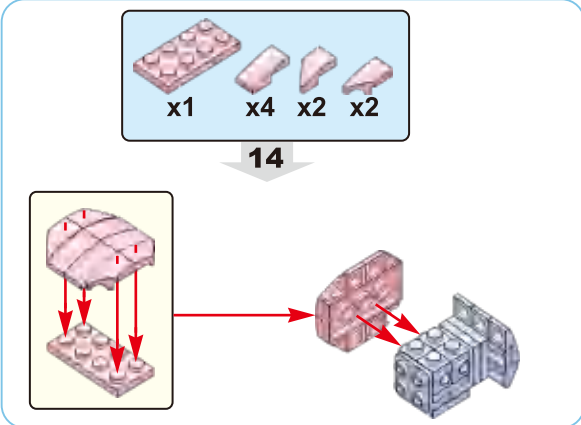
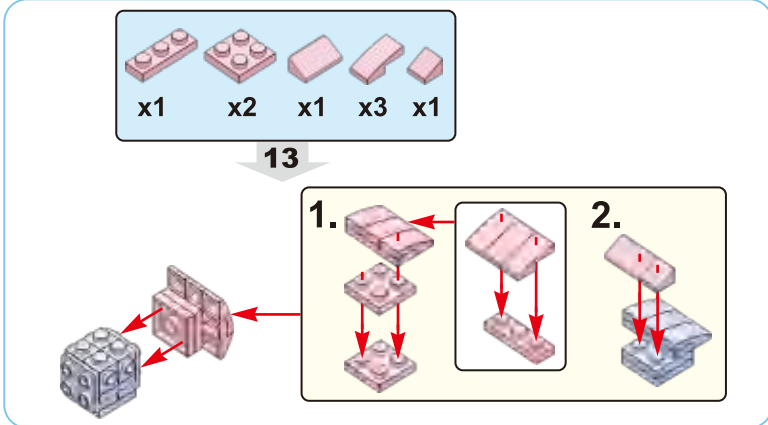
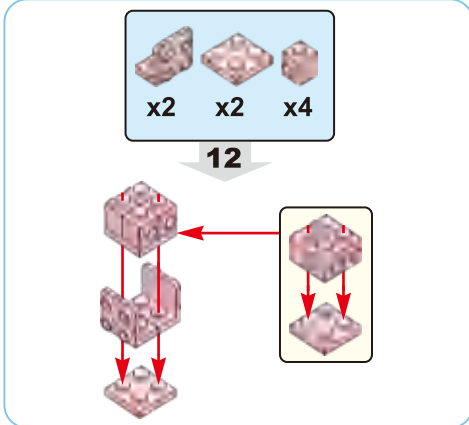
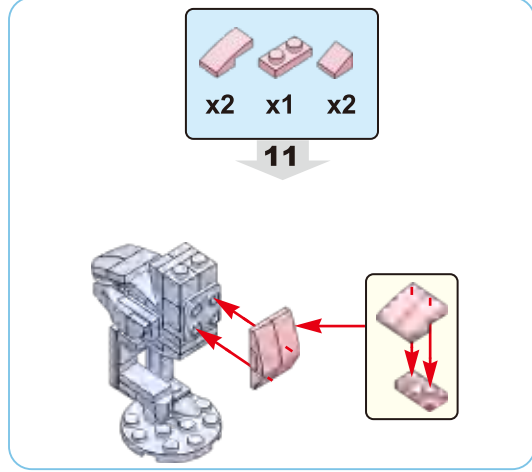
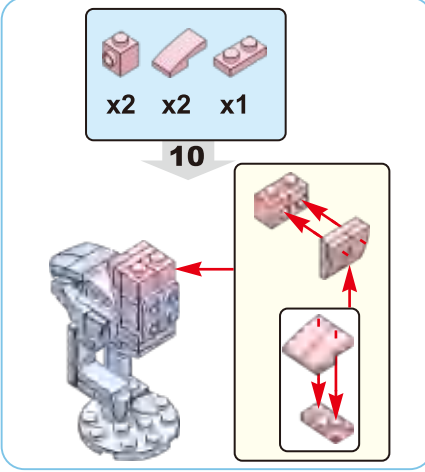
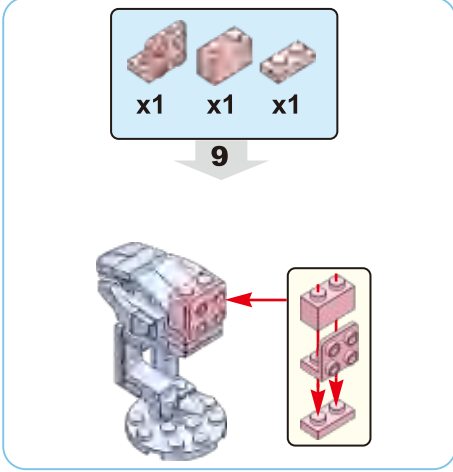
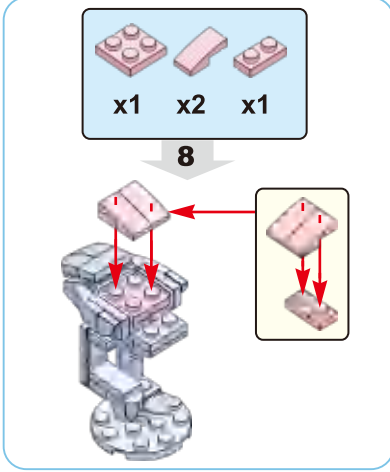
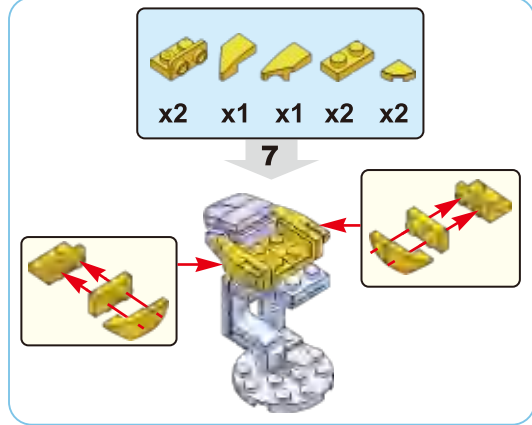
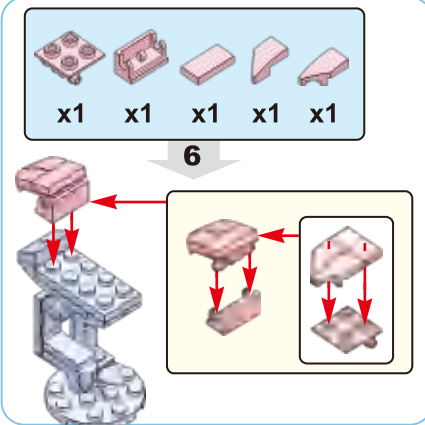
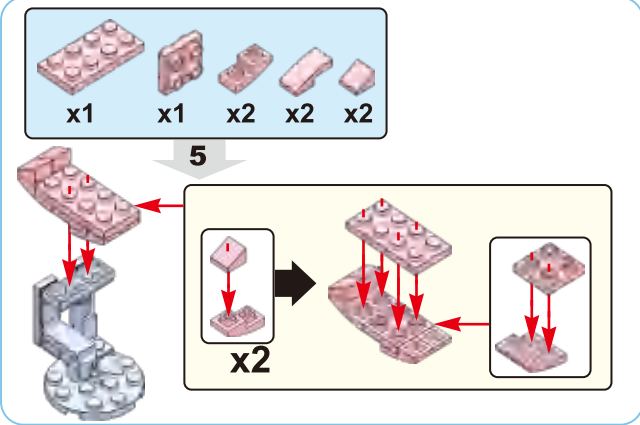
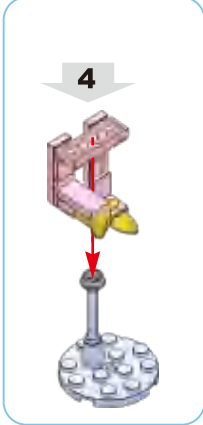
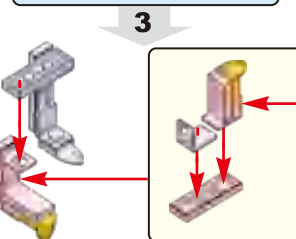
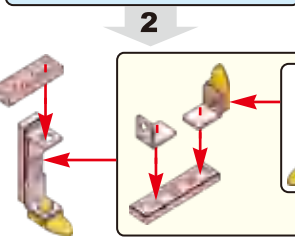
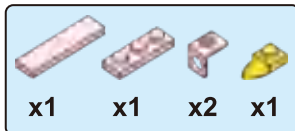
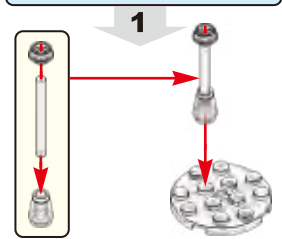
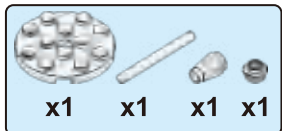

6+ YEARS

Instructions



110PCS

WARNING: CHOKING HAZARD - Small parts. Not for children under 3 years.

1

x1 x2 x2 x2

2

x1 x1 x4 x1 x1

3

x1 x1 x1 x1

4

x1 x1 x2

5

x1 x4

6

x1 x2 x1 x1

7

x1 x1 x1 x1

8

x1 x1 x2

9

x1 x2 x2 x1 x1

10

x2 x1 x1 x4

11

x1 x2 x1 x2 x1 x1

12

x1 x4 x2 x2

13

x1 x2 x1 x2 x1 x1

14

x1 x1 x1 x2

15

x2 x2 x1 x4

16

x1 x1 x2 x4

17

x1 x1 x1 x1 x1 x2

18

6+ YEARS

Instructions



100PCS

WARNING: CHOKING HAZARD - Small parts. Not for children under 3 years.

1

x1 x4

2

x1 x1 x1 x1 x1 x1

3

x1 x1 x1

4

x3 x1 x1 x1

5

x3 x1 x1 x1

6

x1 x1

7

x2 x1 x1 x4

8

x1 x4 x2 x2

9

x1 x2 x1 x3 x1

1. 2.

10

x1 x1 x2 x1 x3 x1

1. 2.

11

x2 x2 x2 x1

12

x1 x1 x2 x2 x2

13

14

x1 x1

15

x1 x1 x2

16

x1 x2 x1 x2 x2

17

x1 x2 x2 x1 x1 x1 x1

18

6+ YEARS

Instructions

119PCS

WARNING: CHOKING HAZARD - Small parts. Not for children under 3 years.

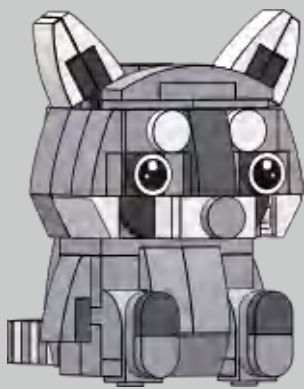

- x1
- x1
- x4
- x2

1

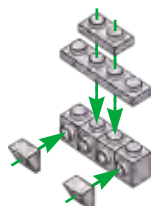

- x2
- x4

2

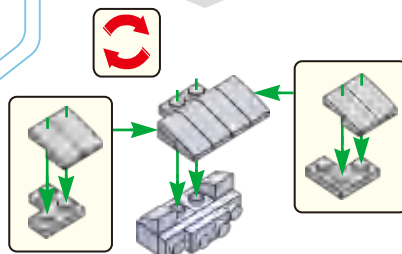

- x1
- x3
- x3
- x1
- x2

3

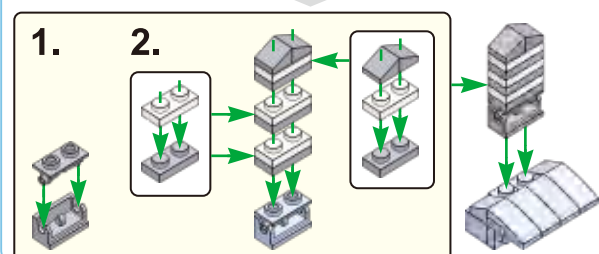

- x2
- x2
- x2
- x2

4

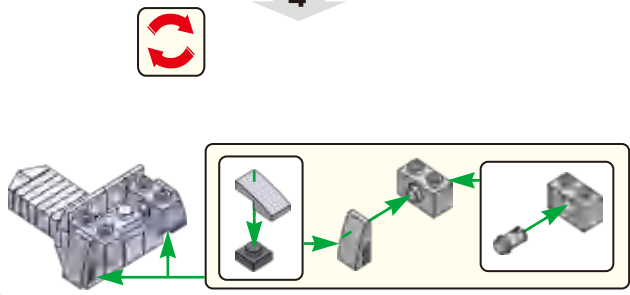

- x2
- x2
- x2
- x2

5

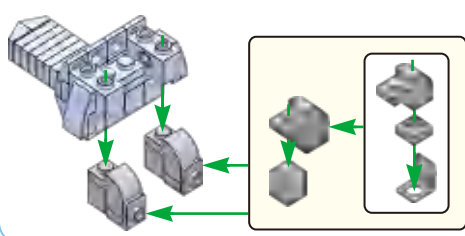

- x1
- x2
- x1
- x2
- x1

6

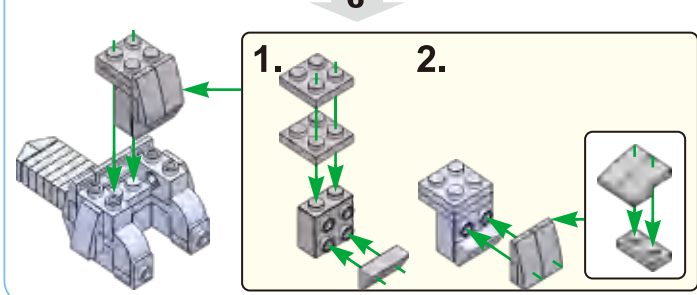

- x1
- x4

7

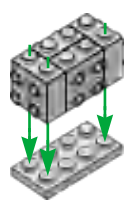

- x1
- x4
- x2
- x2

8

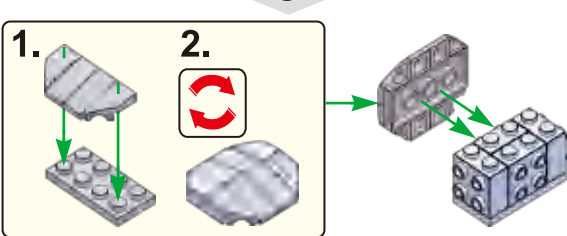

- x1
- x2
- x1
- x1
- x2

9

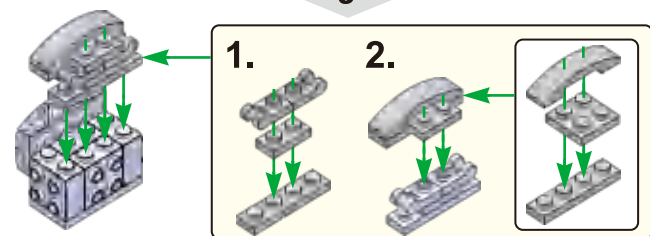

- x2
- x1
- x2
- x2
- x2

10

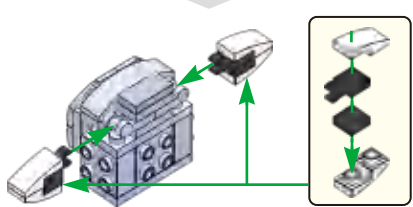

- x2
- x1
- x2
- x1

11

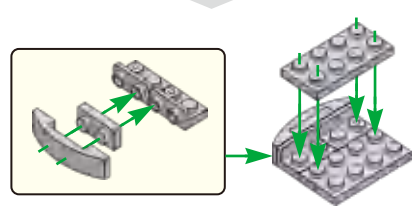

- x3
- x2
- x2

12

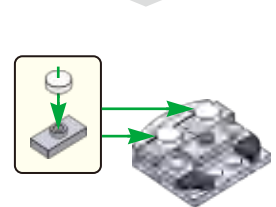

- x1
- x3
- x1
- x1

13

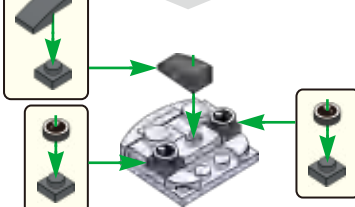

- x1
- x1
- x1

14

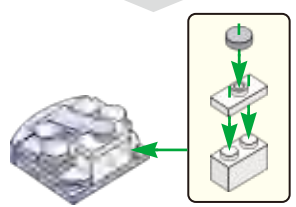

15

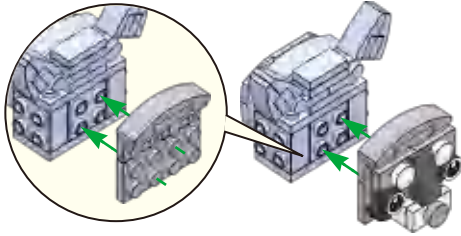

- x1
- x1

16

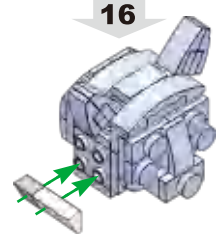

- x1
- x3
- x1

17

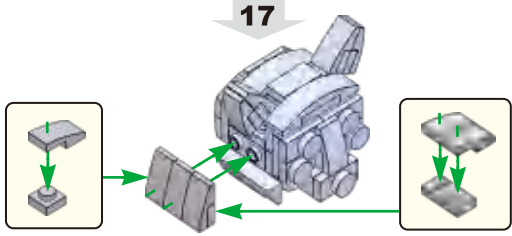

- x1
- x1

18

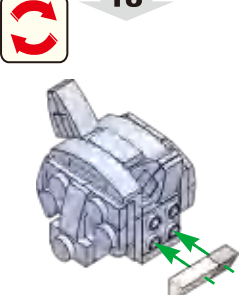

- x1
- x3
- x1

19

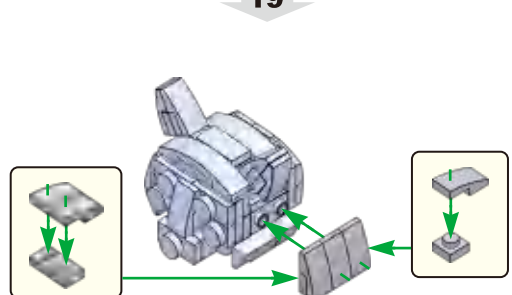

20

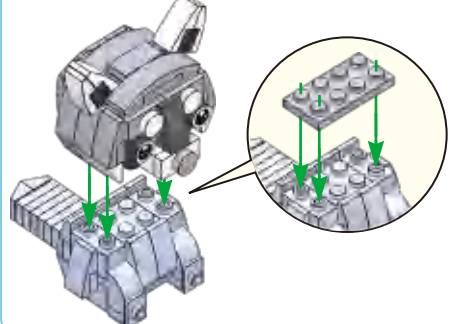

- x2
- x2
- x2

21

