

- For better preservation of rechargeable batteries, please regularly recharge it, and only a charger of the same or equivalent type is recommended to be used.
- Dispose of batteries responsibly, do not dispose of in fire.

# INSTRUCTIONS

- When your vehicle starts to lose power, it may lose its functions or performance. This indicates that it's time to refresh your batteries or recharge them.



- Do not operate your car on the streets where people gather or under high voltage wires. Stay safe!

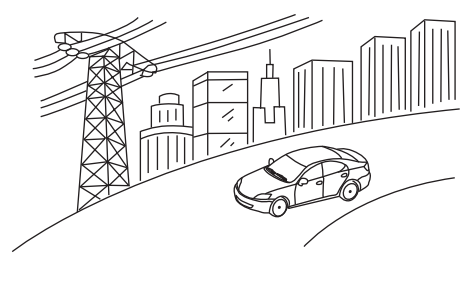

- Don't drive your vehicle in sand, through water or snow.



- Point your transmitter antenna up not down toward your vehicle. If your vehicle gets too far away, it won't work properly. If your transmitter has an antenna carry-loop feature, make sure the antenna is removed from the holder and straightened before operating.

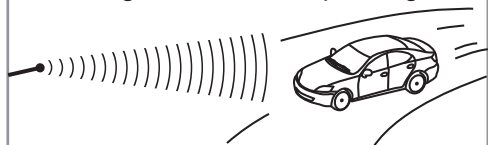

- Don't put your vehicle near heat or in direct sunlight. Always turn switches OFF after operating.

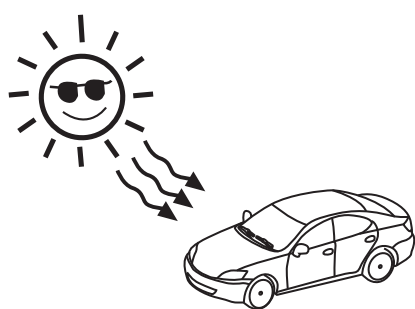

This manual is applicable to the following types of product:

15000,26010,26910,35400,36000,36200,36500,38800,39000,39001,39700,39800,39900,40100,40200,44300,44500,44700,46100,46200,46300,46400,46500,46600,46700,46800,46900,47000,48100,48200,48300,48400,48500,48600,48700,48800,48900,49000,71200,71400,71410,71500,71600,71700,71800,71900,72000,72100,72200,72300,75200,76000,76100,76200,78200,78800,79300,95800,96100,96110,96200,96700,97600,97800,98800,98900,93100,99700,92900.

Frequency bands: 2400MHz to 2483.5MHz

Maximum Transmitting Power (EIRP) : Not more than 10mW.

**! WARNING:**  
This toy produces flashes that may trigger epilepsy in sensitised individuals.

**! WARNING:**  
CHOKING HAZARD-Small parts.  
Not for children under 3 years.

The instruction has to be kept since it contains important information.

## RASTAR GROUP

Add: Xinghui Industrial Park, Xiadao Road, Shanghai, Chenghai, Shantou, Guangdong, China.

Http://www.rastar.com

01.04.00024.02901

## MAINTENANCE

- Remove the batteries when the unit is not in use for long periods of time.
- Clean the vehicle with a soft cloth.
- Avoid being heated or being exposed to strong sunlight.
- Keep dry.
- Regularly examine the toy for any damage to its wires, plug, enclosure and other parts. Do not use until the damage has been repaired.

Picture for reference only, subject to actual product.

## OPERATION GUIDE

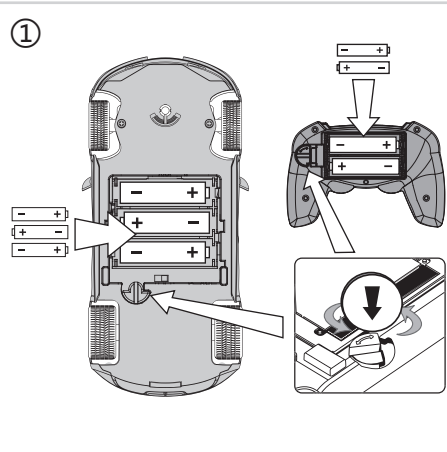

- The fixing piece for chassis can be used to twist the lock of the battery cover, See picture 1.

- Open the lid and put 3 x AA batteries into the car according to its polarity, then close the lid.

- Open the lid and put the 2 x AA batteries into the controller according to its polarity, then close the lid and rotate the knob to lock the battery cover. See picture 1.

- Every time before playing, the transmitter needs to pair with the model car as follows:

- ◆ The LED indicator on the transmitter will blink and ready for pairing. Switch on the model car, the LED on the transmitter will go out. This means the pairing process is completed. Then the model car can be fully controlled by the transmitter. See picture 3.

- Adjust the direction adjustment switch to control the car running in a straight line.

- Please replace battery when LED indicator becomes dark which means low battery.

- The speed of model car will slow down when battery is low. Please replace then.

- 2.4GHz transmitters are compatible to control several model cars at the same time without interference, provided that the pairing process is orderly done one by one following above steps. That is, first transmitter finishes pairing with first model car and keep their power on, then second transmitter can begin to pair with second model car...

- Please turn off the model car after playing.

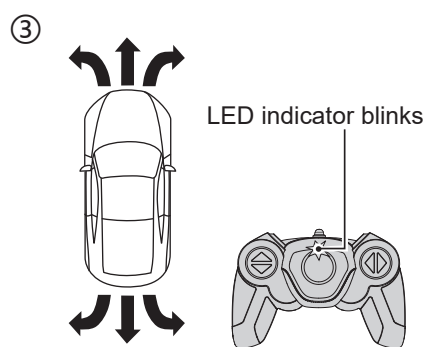
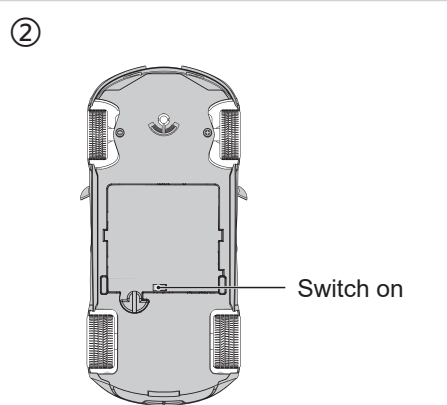

When LED indicator goes out, pairing process is completed.

## FEATURES & FUNCTION

This product uses 2.4GHz communication technology, which is compatible for multi-device and multi-user, with fast response speed, high response precision, and strong anti-interference capability.

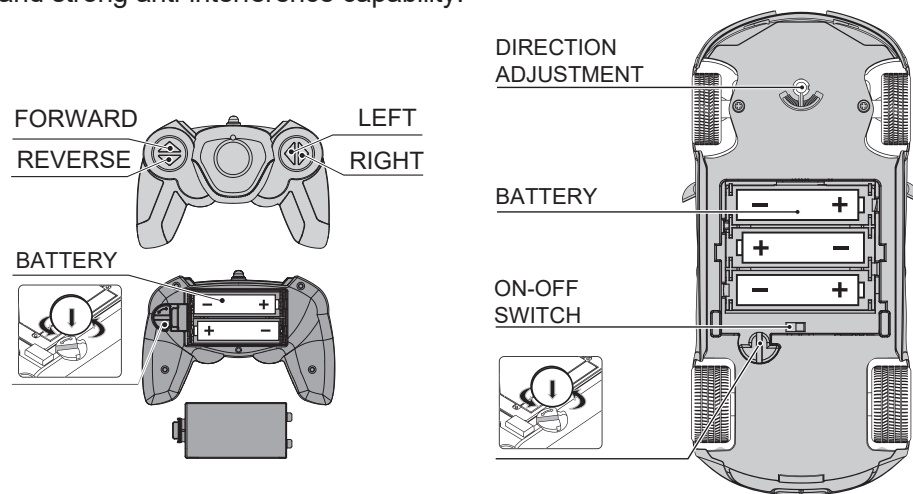

Function: Forward, Reverse, Turn Left, Turn Right.  
Features: Authentic car styling with injection moulded body, independent suspension system.

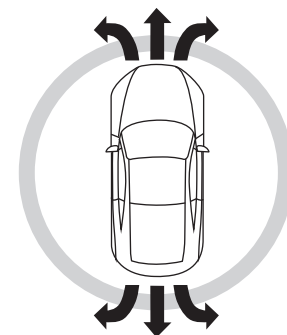
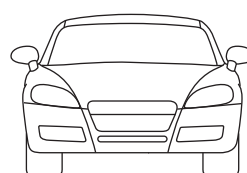
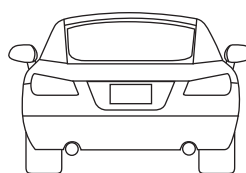

## CAUTION

- Different types of batteries or new and used batteries are not to be mixed. Exhausted batteries are to be removed from the toy.
- Batteries should be replaced by an adult. Batteries are to be inserted with the correct polarity. The supply terminals are not to be short-circuited.
- Non-rechargeable batteries are not to be recharged. Rechargeable batteries are to be removed from the toy before being charged. Batteries are to be charged by an adult or by children at least 8 years old, leaked or broken batteries are not to be charged.
- Rechargeable batteries are only to be charged under adult supervision.
- Only batteries of the same or equivalent type is recommended to be used.
- Never put the batteries near fire or any source of heat, water or direct sunlight.
- Skin or clothing is to be washed immediately if you make contact with leaked liquid from the battery.