

Flower Shop Instructions

6+
years



Building
Series

306
PIECES

Difficulty Level

 **WARNING:** CHOKING HAZARD
SMALL PARTS. NOT FOR CHILDREN UNDER 3 YEARS.

1

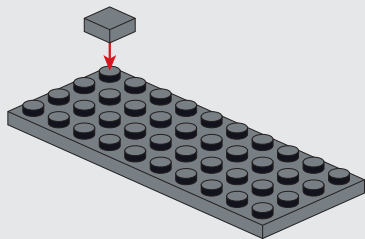
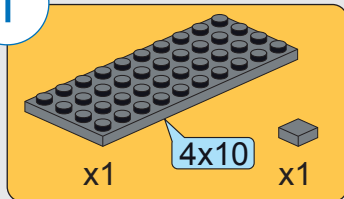

1

2

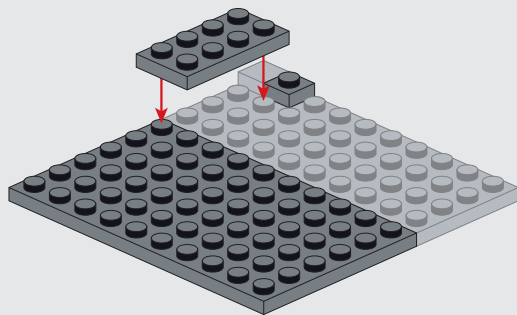
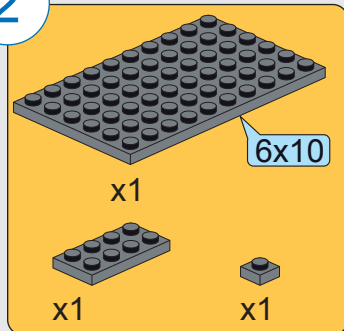

3



x1

x1

x1

x1

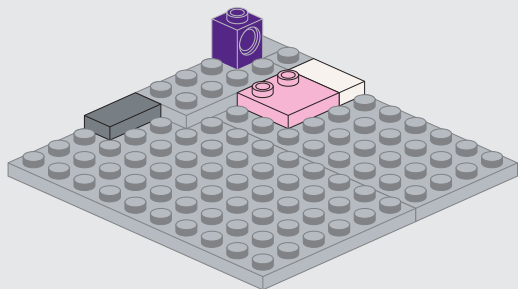

4



x1

x1

x1

x1

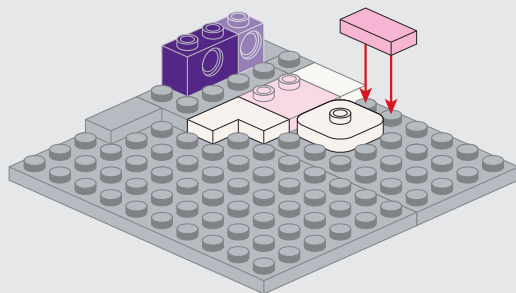

5



x1 x1 x1 x1

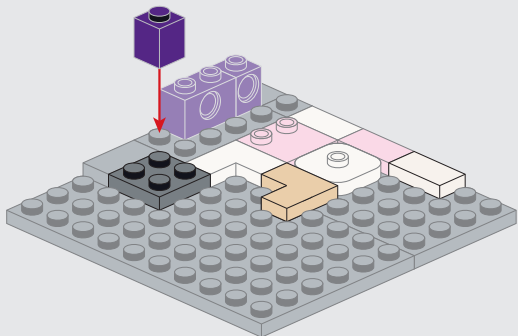

3

6



x1 x1 x1 x1

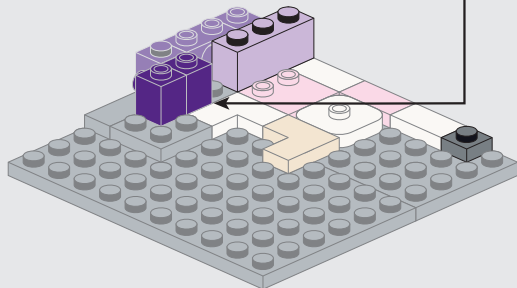
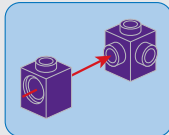

7



x1

x1



x1

x1

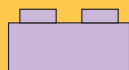

1:1

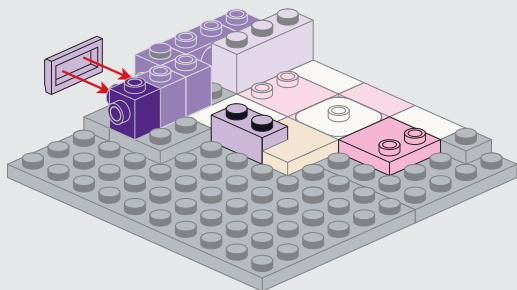

8



x1

x1

x1

x1

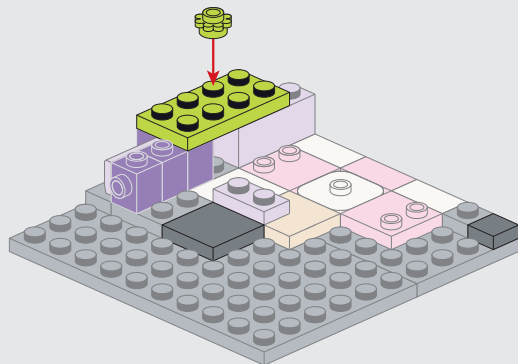

9



x1



x1



x1

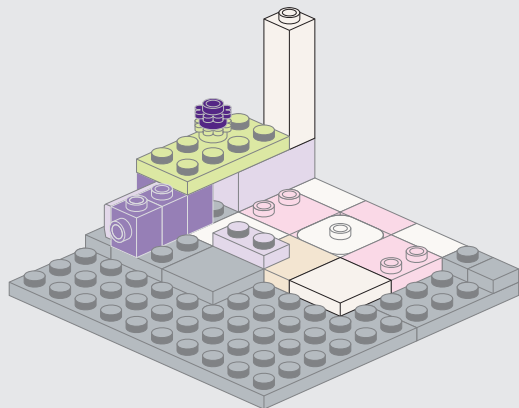

5

10



x1



x1



x1



x1



x1

1



2

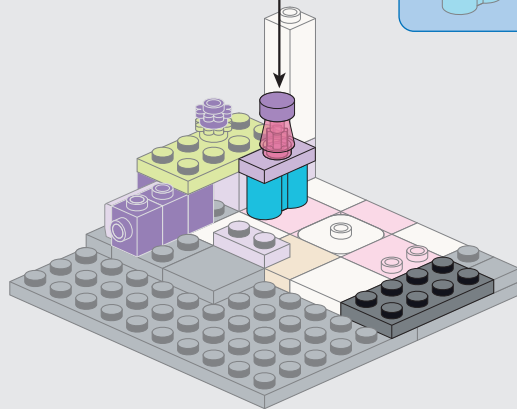

11

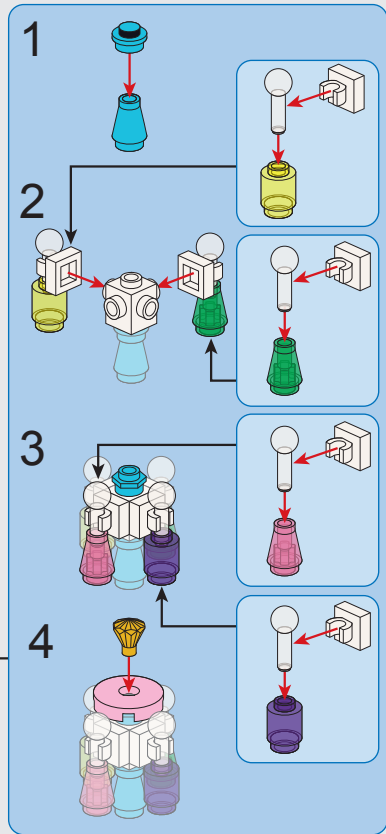
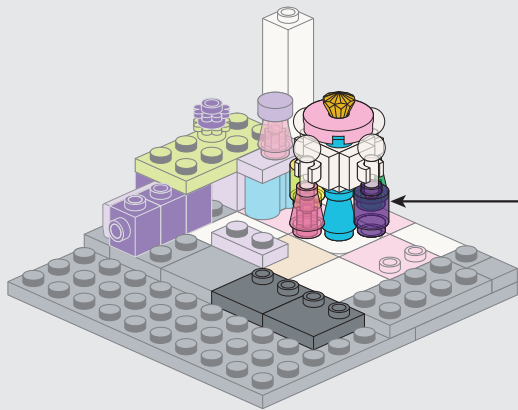

6

12

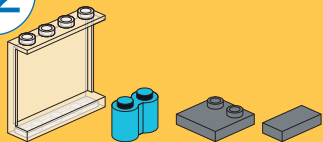

x1

x1

x1

x2

x1

x1

x1

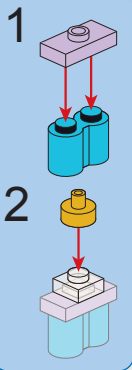

1

2

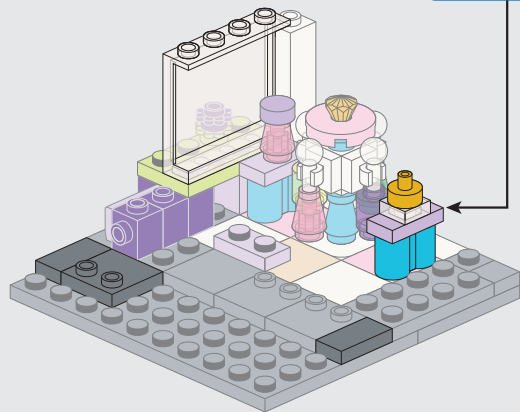

13

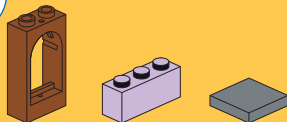

x1

x1

x3

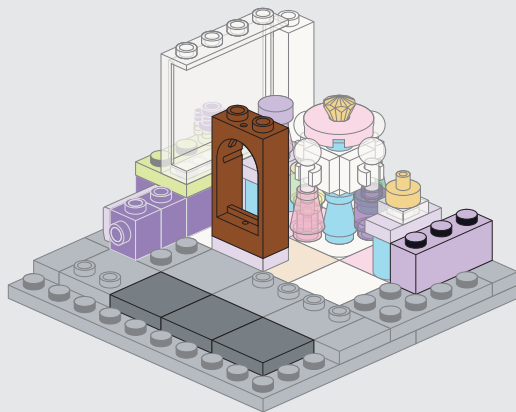

14



x1

x1

x2

x2

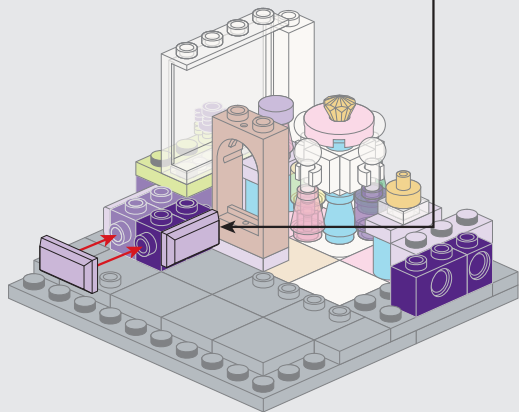
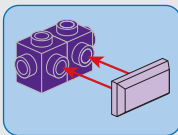

15

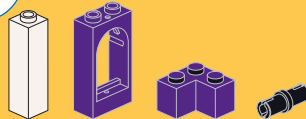

x1

x1

x1

x2

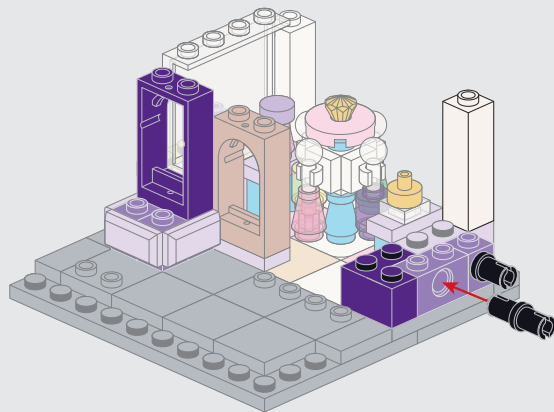

16

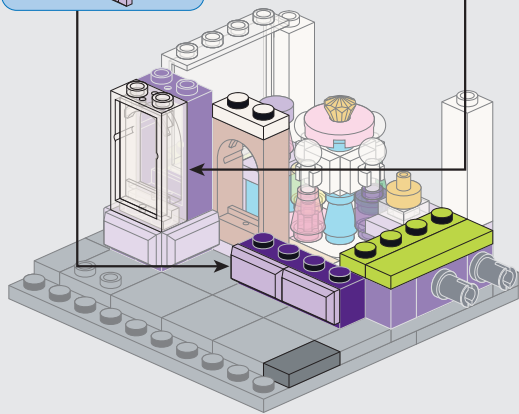
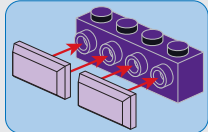
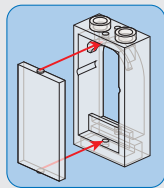
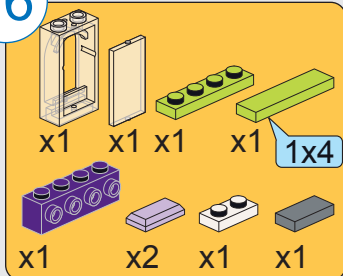

17

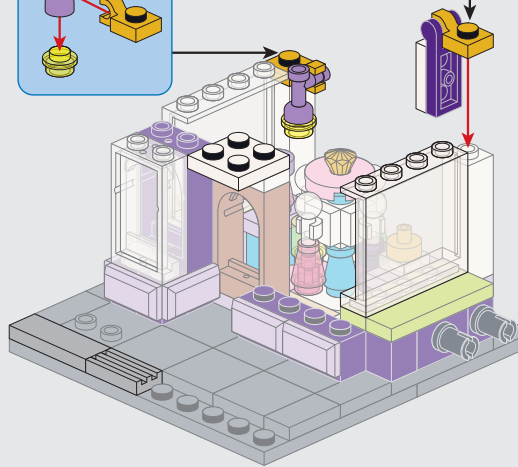
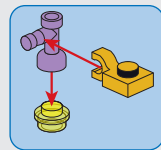
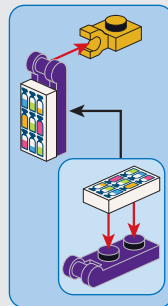
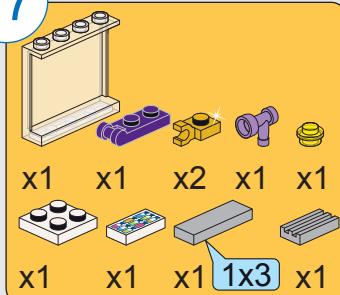

18

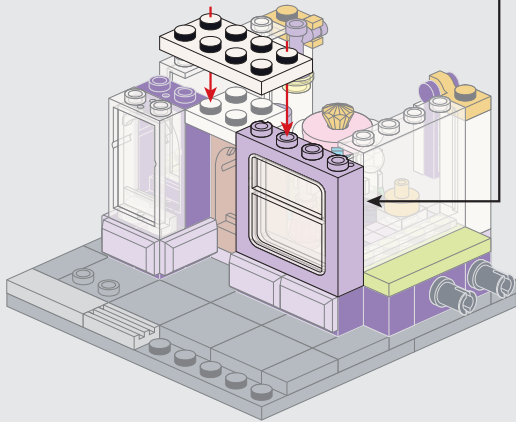
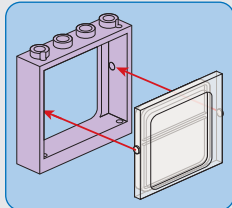
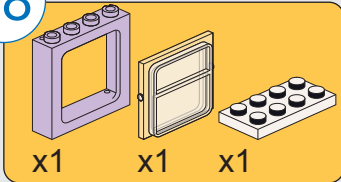

19

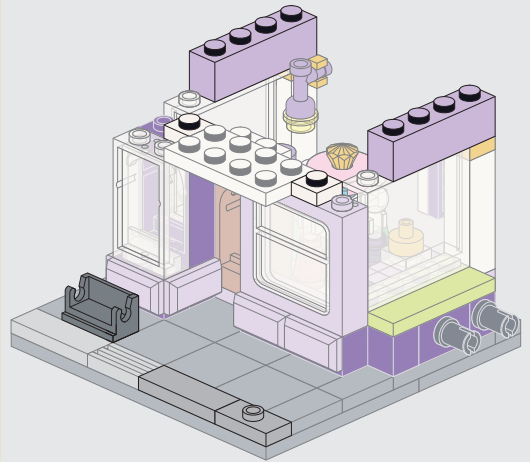
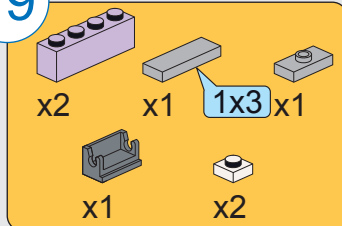

20

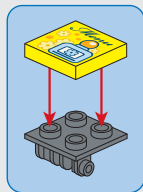
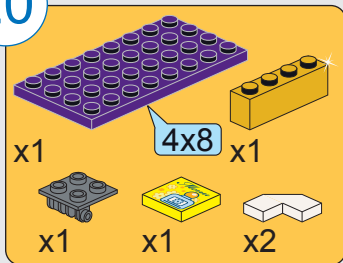

21

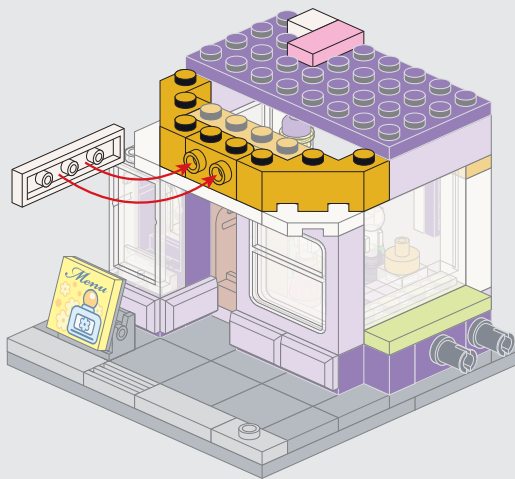
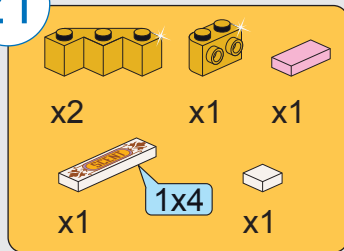

22

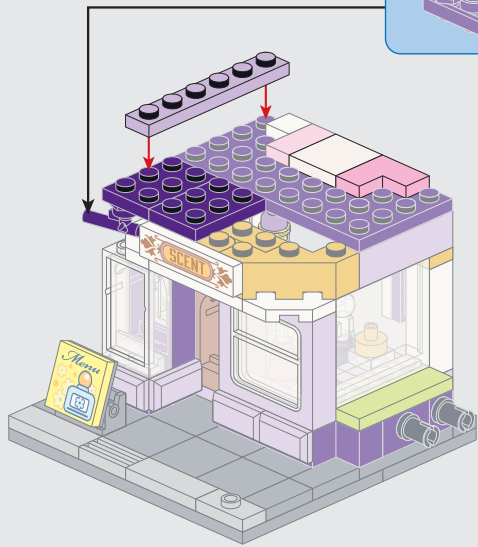
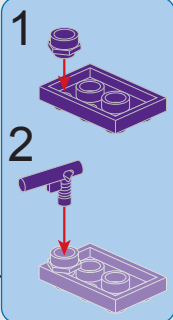
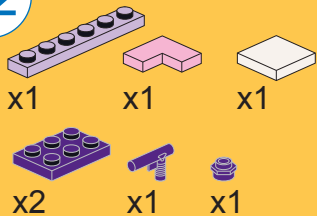

23

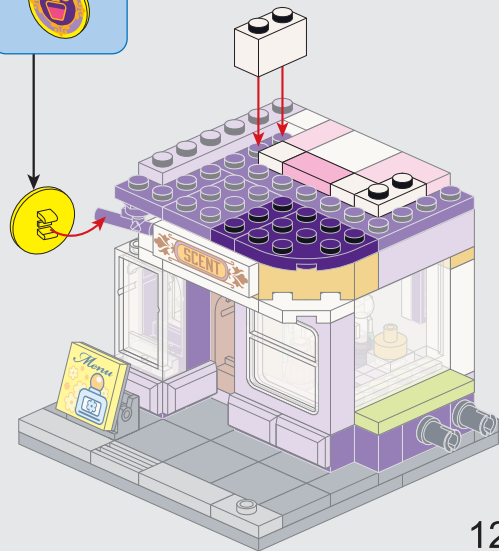
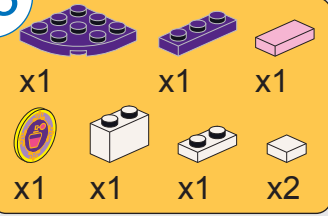

24



x1



x1



x1

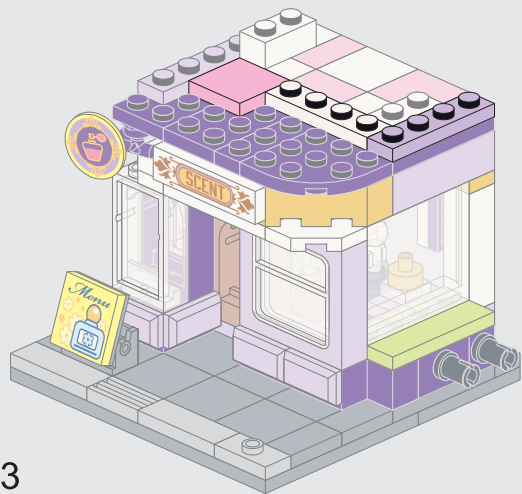

13

25



x2



x1



x1



x1

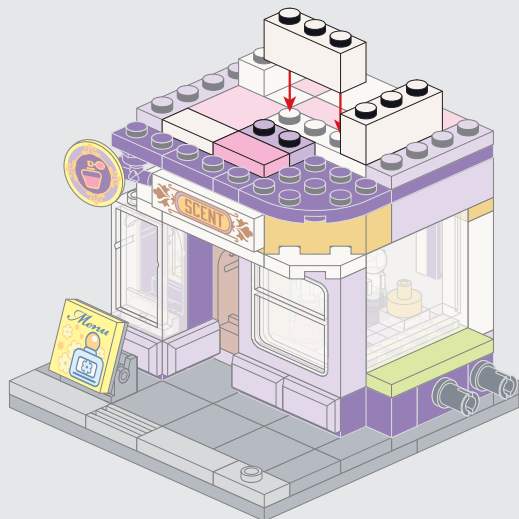

26



x1

x1

x1

x1



27

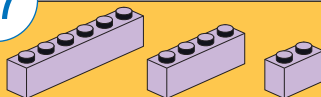

x1

x1

x1

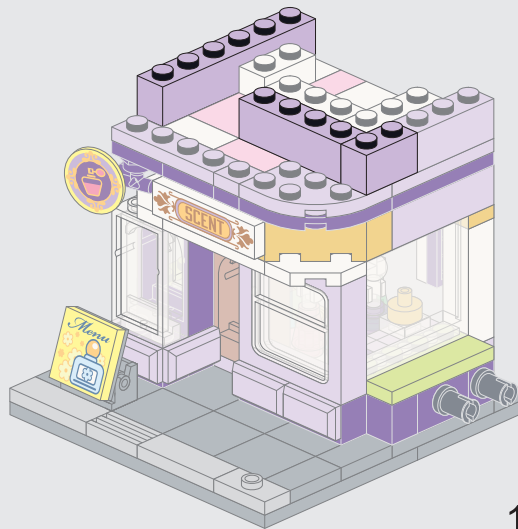

28



x1



x1



x2

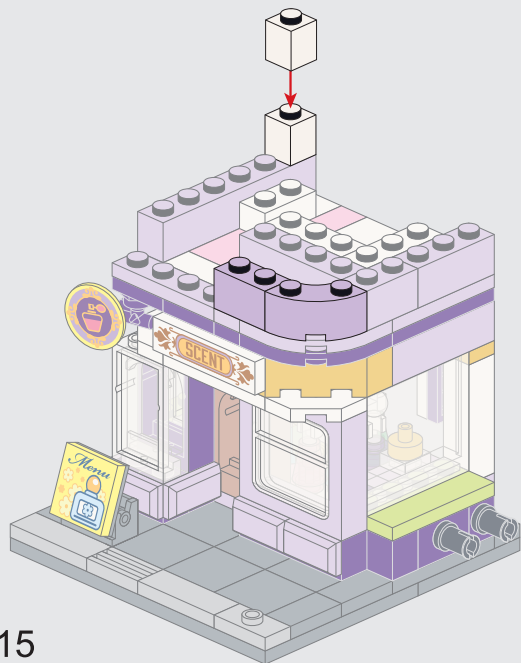

15

29

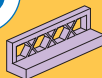

x1



x1



x1



x1

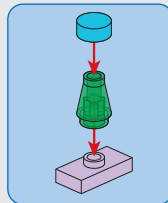

30

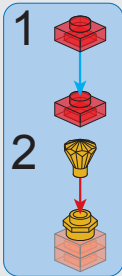
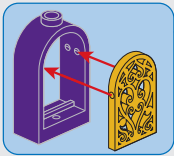

31

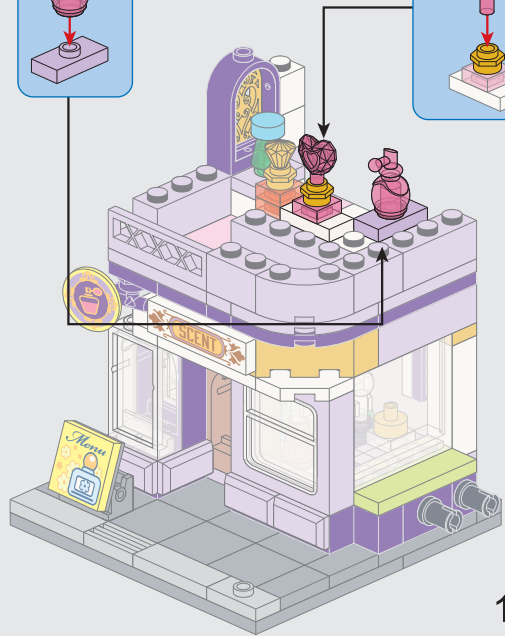
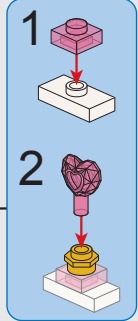
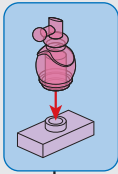
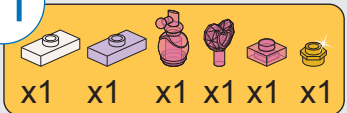

32



x2



x2



x1



x1

1



2



33



x1



x1



x4

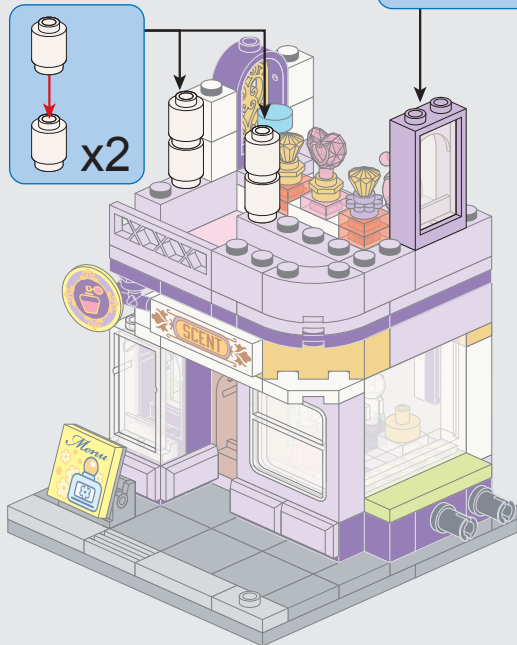
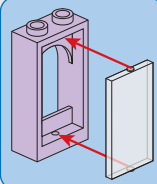

34



x2



x1



x4



35

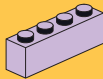

x2



x2



x2



36

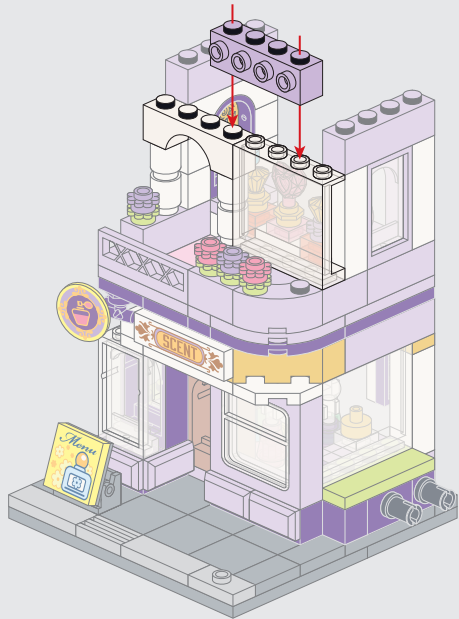
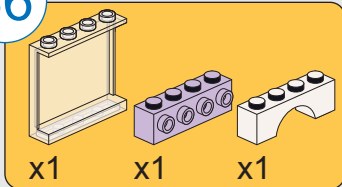

37

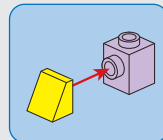
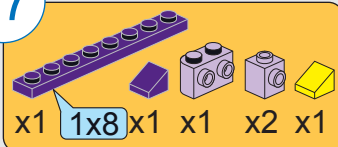

38

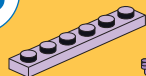

x2



x1



x1

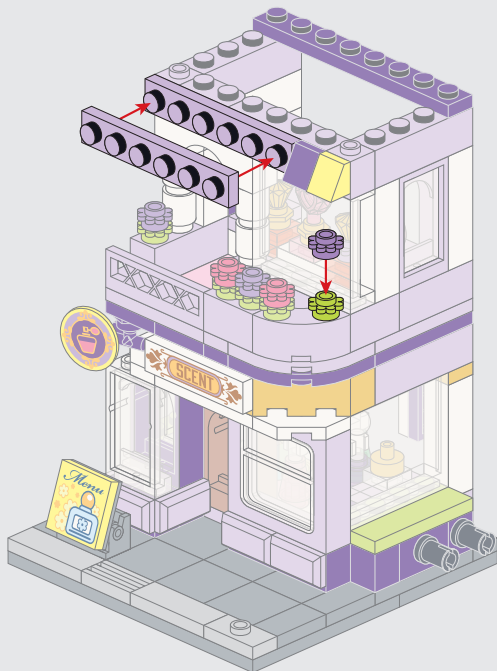

39



x3



x3



40

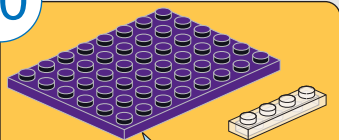

x1

6x8 x1

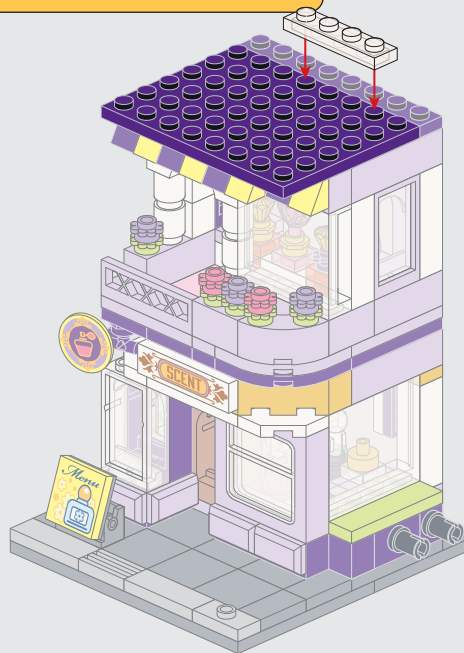

21

41



x1

x3

x2



42



x1



x2



x1



43

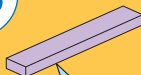

x2

1x6



x1

1x4

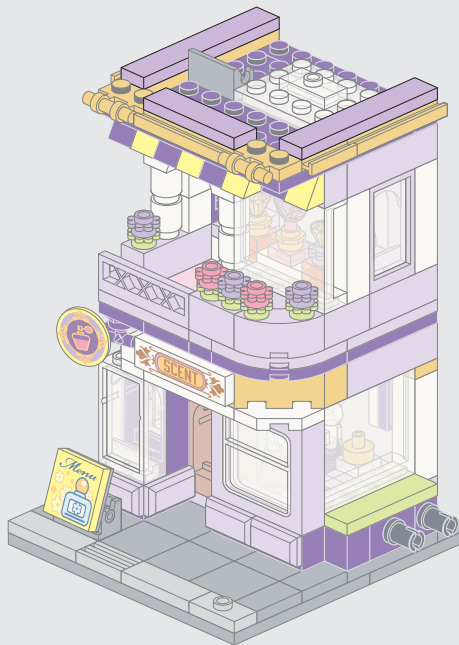

44

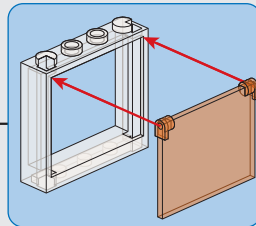
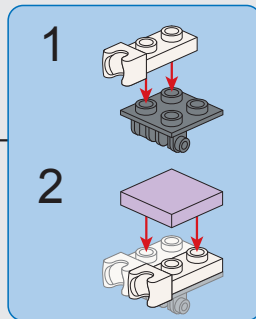
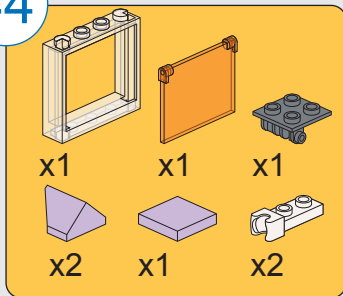

45

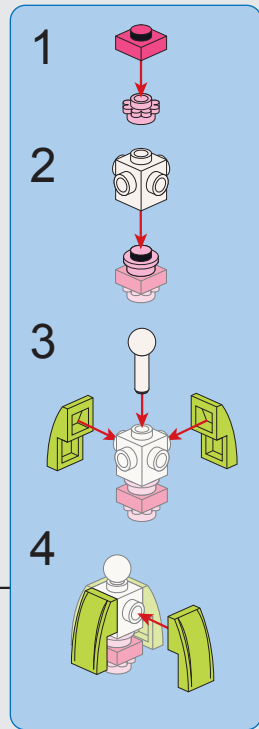

46

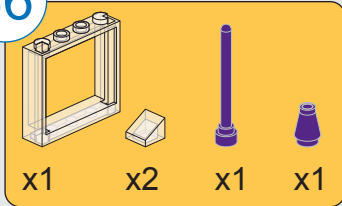

47

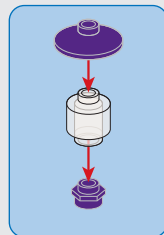
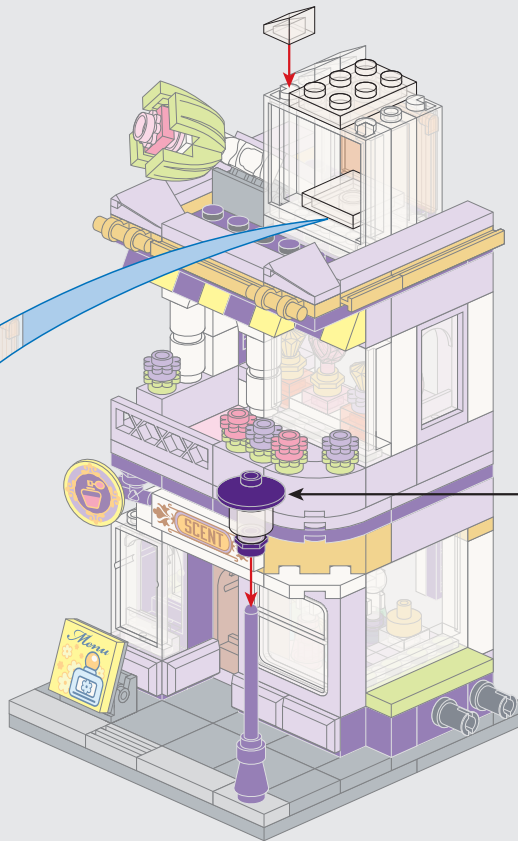
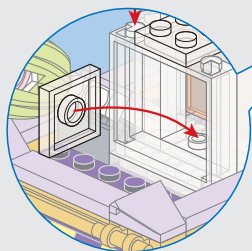
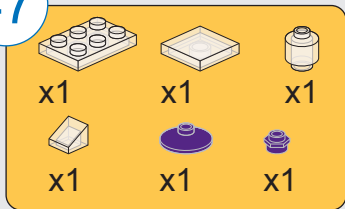

48



x1



x2



x3



49



x1



x1



x1



x4



1

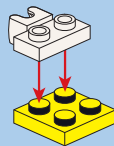

2

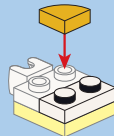

3

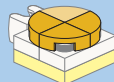

50

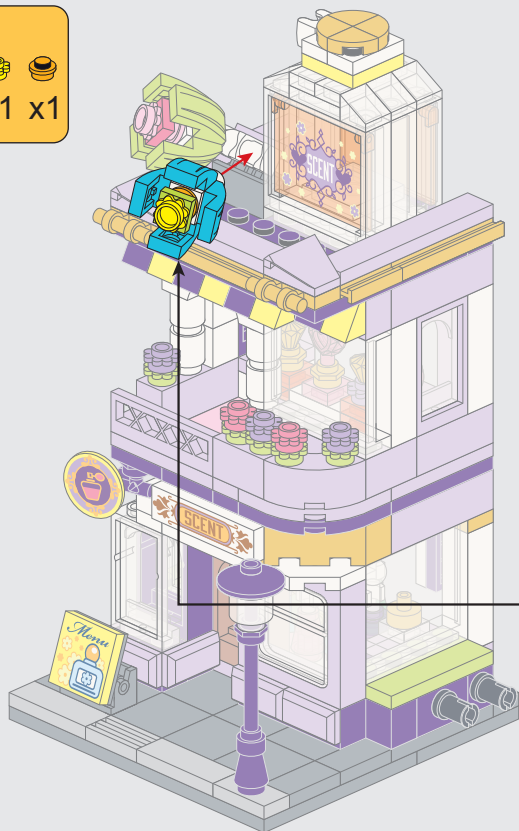
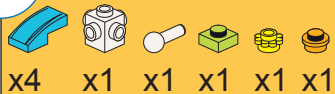

1

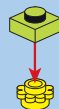

2

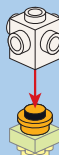

3

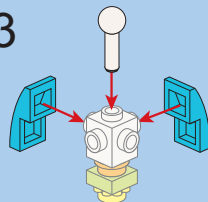

4

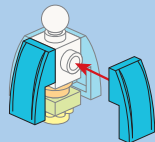

51

x1	x1	x1	x8
x1	x1	x2	x8

1

2

3

4

5

x3

x2

x3

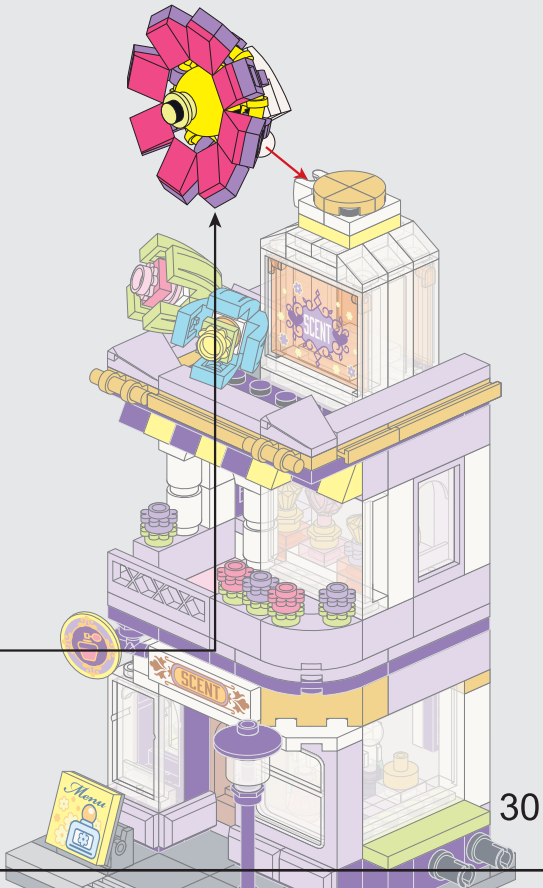

Flower Shop Instructions

› 3 designs to collect



Juice Bar



Dessert Shop



Flower Shop

Dessert Shop Instructions

6+
years



Building
Series

343
PIECES

Difficulty Level



WARNING: CHOKING HAZARD
SMALL PARTS. NOT FOR CHILDREN UNDER 3 YEARS.

1

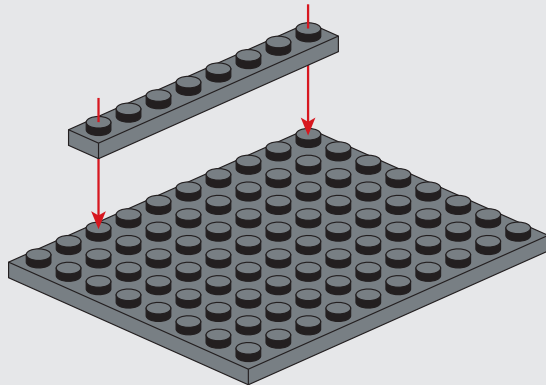
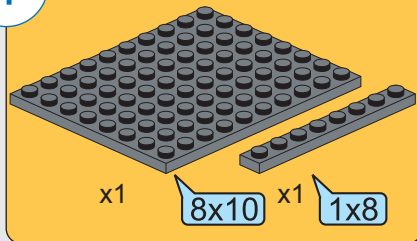

2

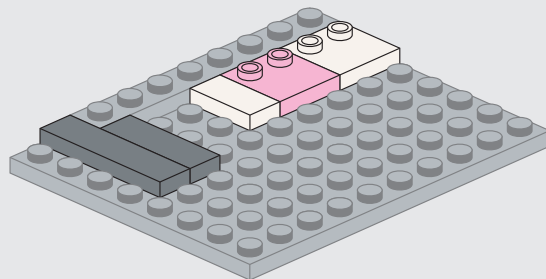
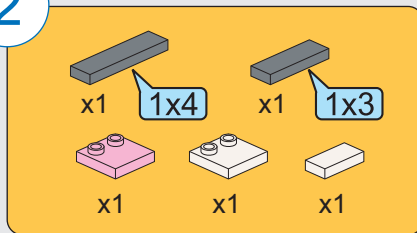

3



x1



x1



x1



x1



x2

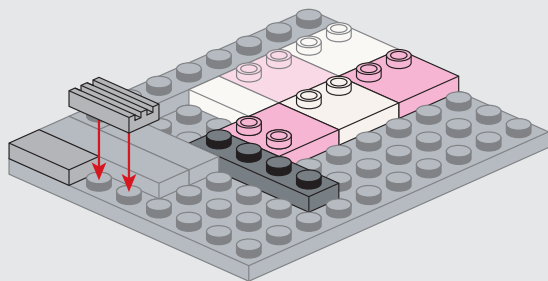

4



x1



x1



x1



x5

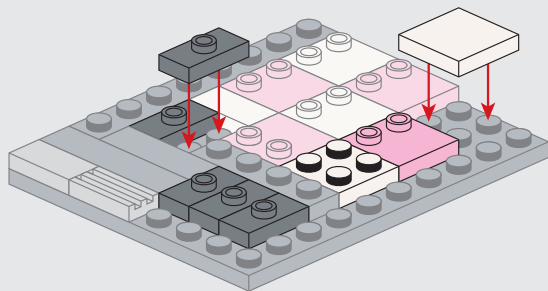

5

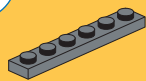

x1



x1



x2



x1



x1



x1

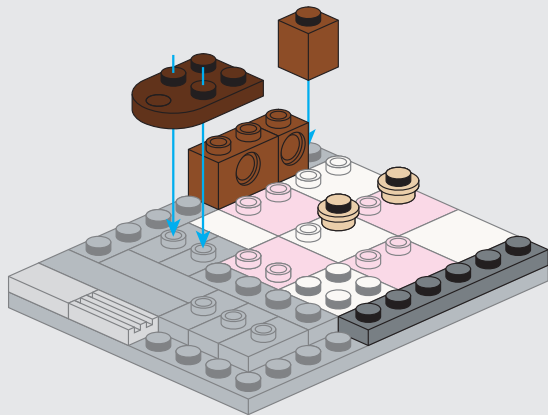

6

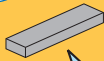

x1

1x4



x1



x1



x1



x2

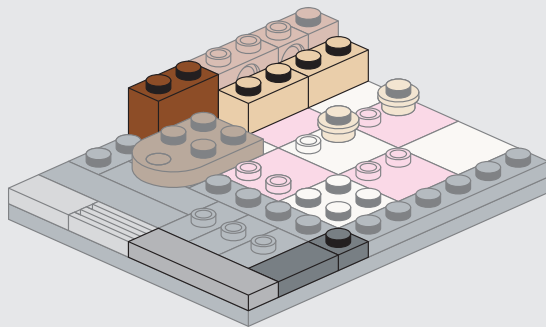
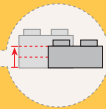

7

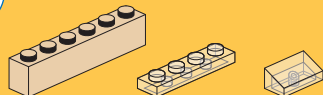

x1

x1

x2



x1

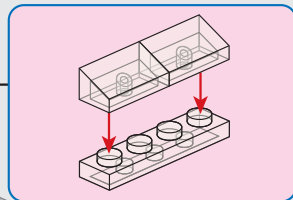
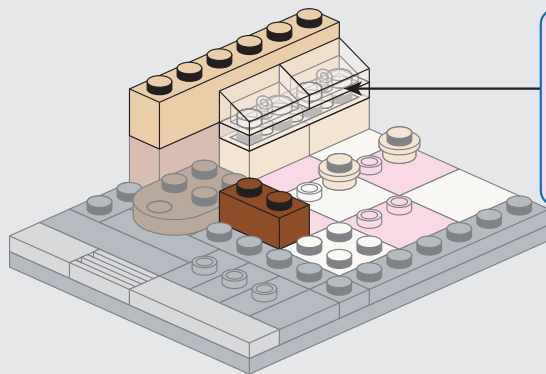
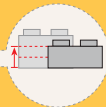

8



x1



x2



x1



x1



x1



x2

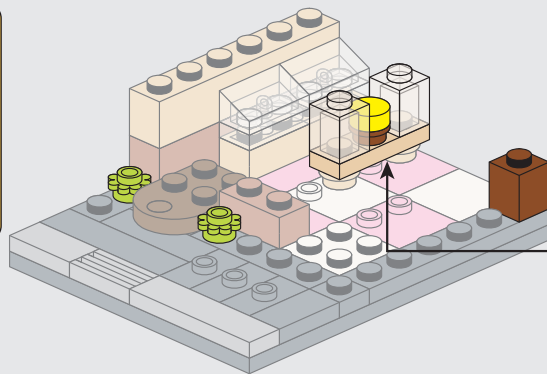

1

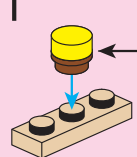

2

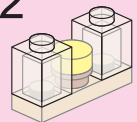

9

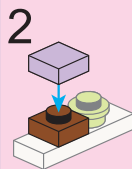
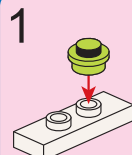
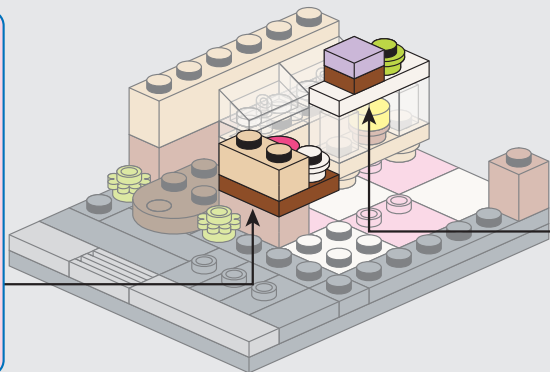
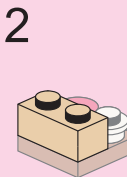
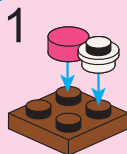
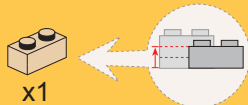

10

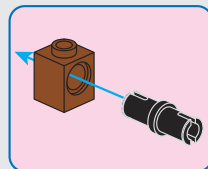
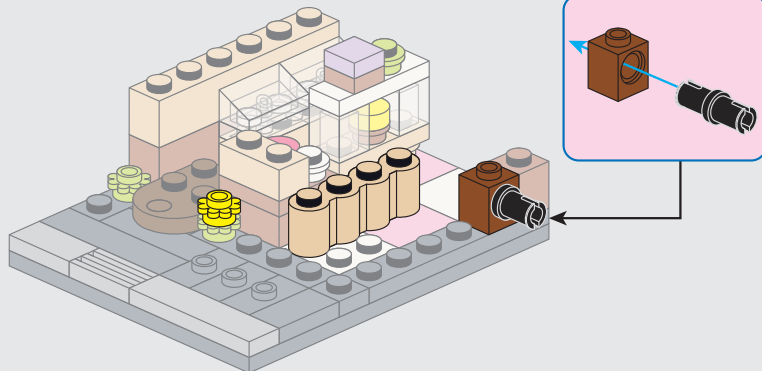

11

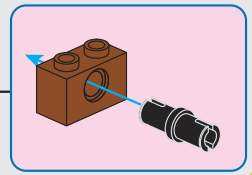
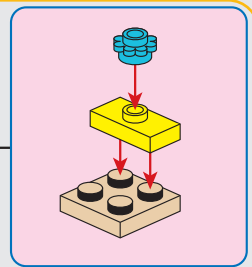
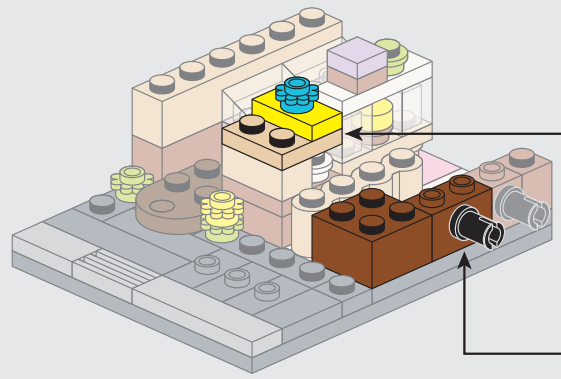
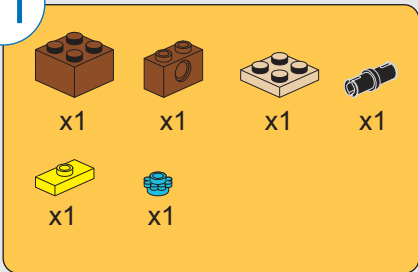

12

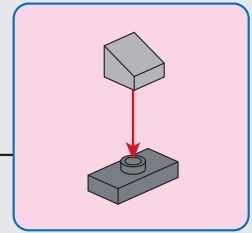
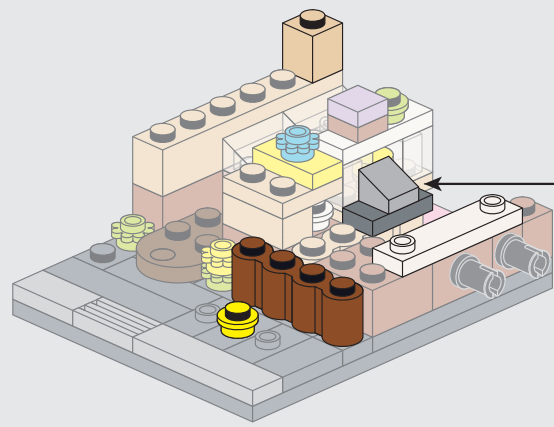
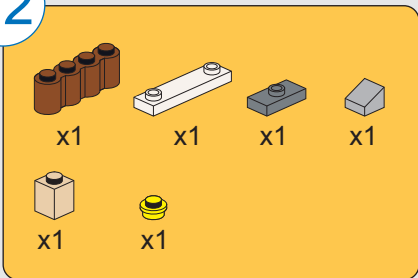

13

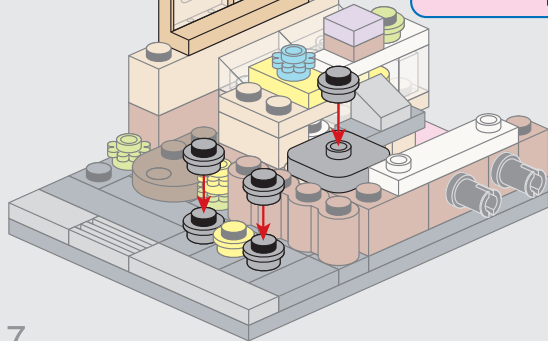
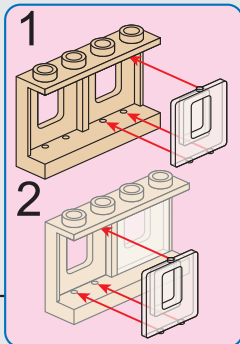
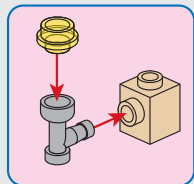
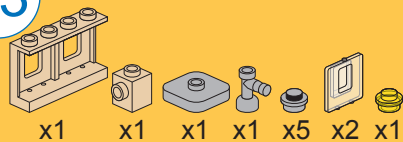

7

14

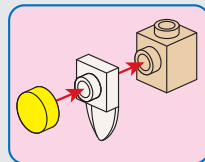

1

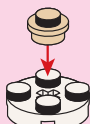

2



3

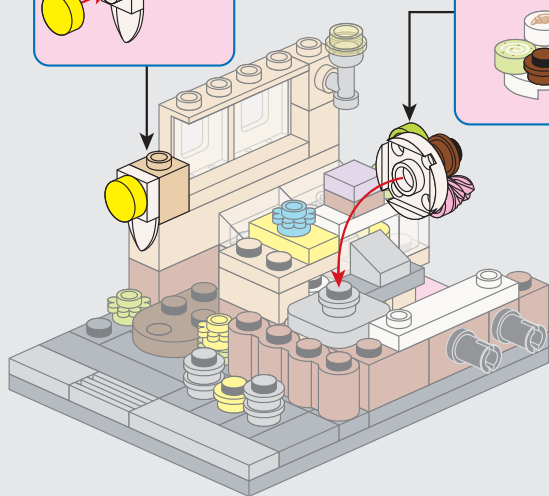

15



x1



x2



x1



x4

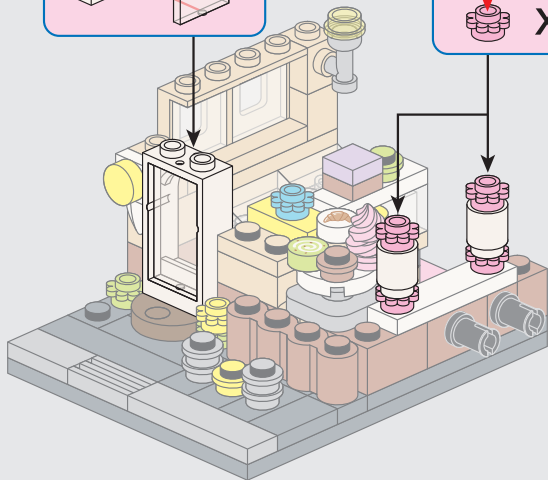
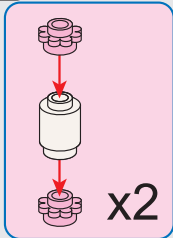
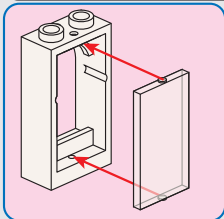

16



x1



x1



x1



x1



x1



x1

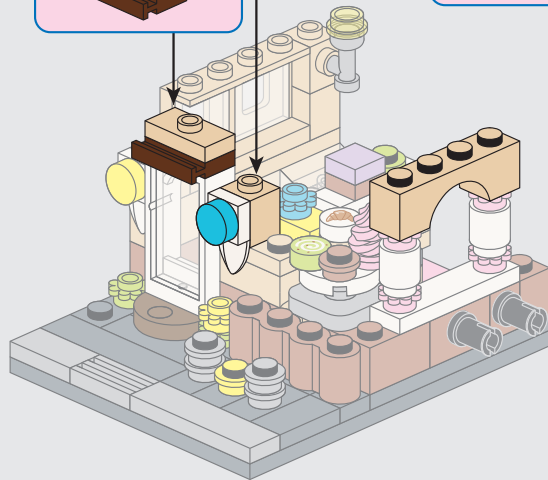
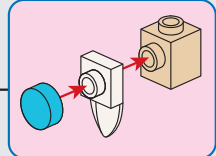
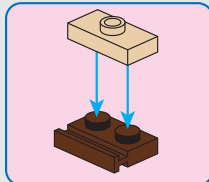

17

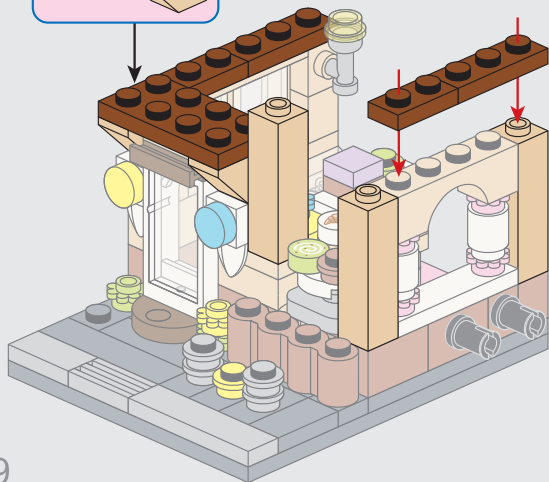
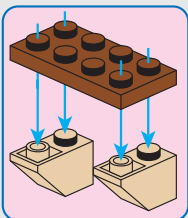
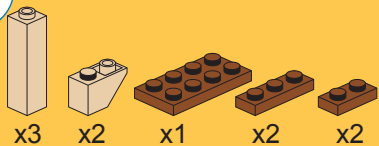

18

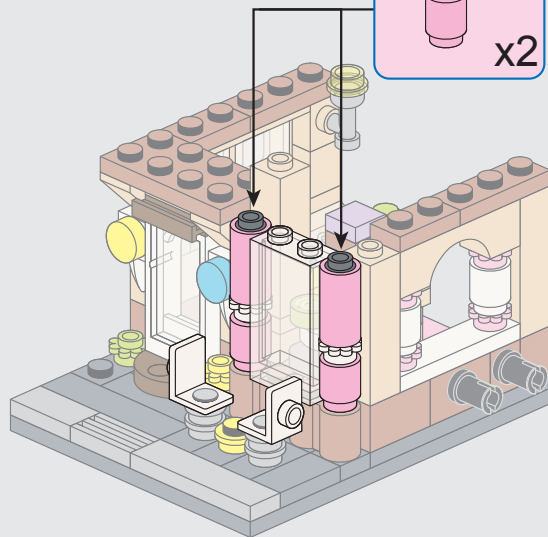
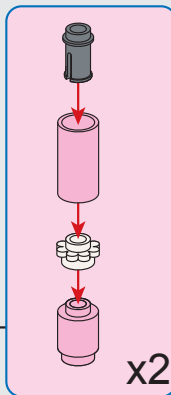
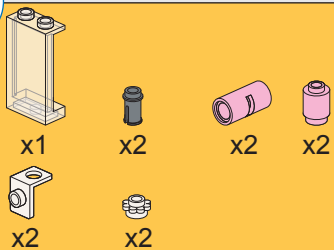

19

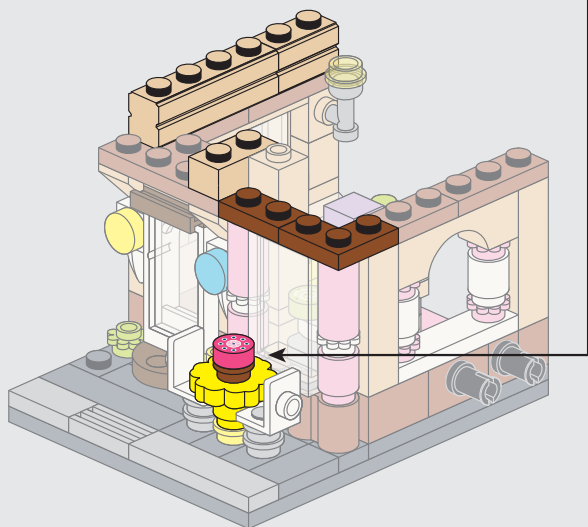
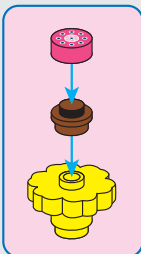
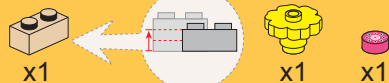
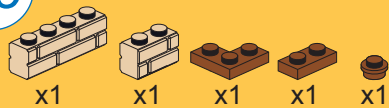

20

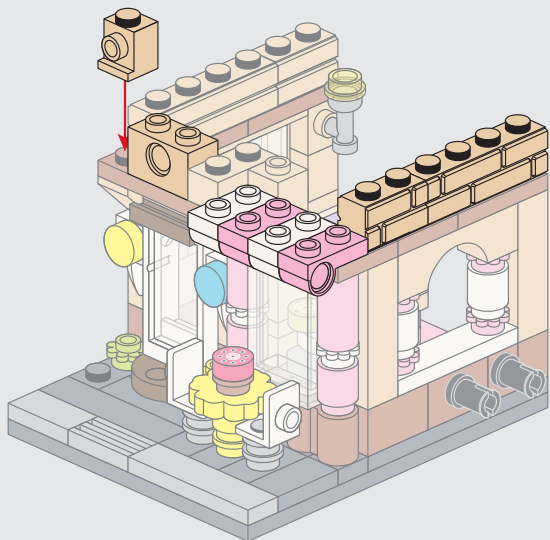
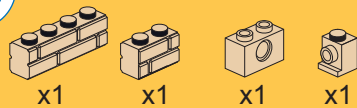

21

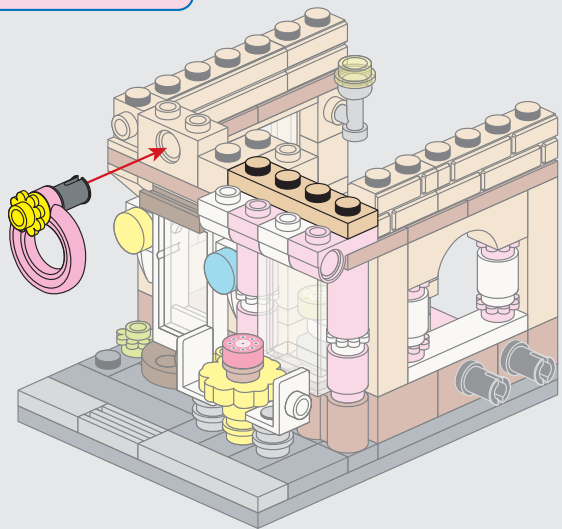
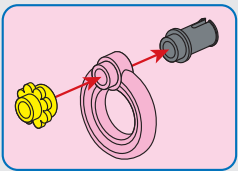

22

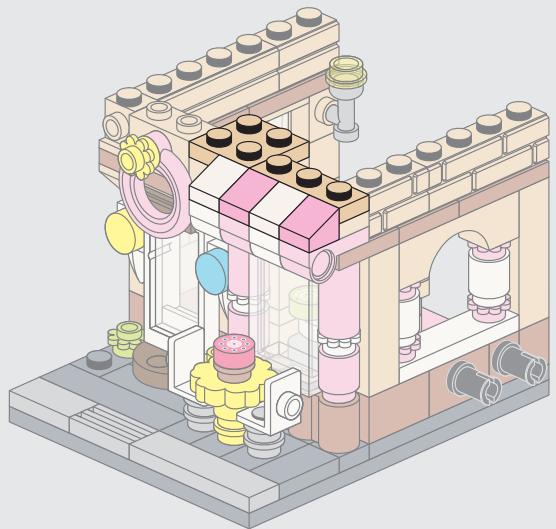
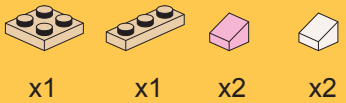

23

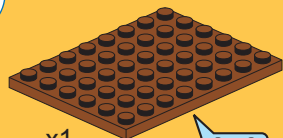

x1

6x8



x1

1x8

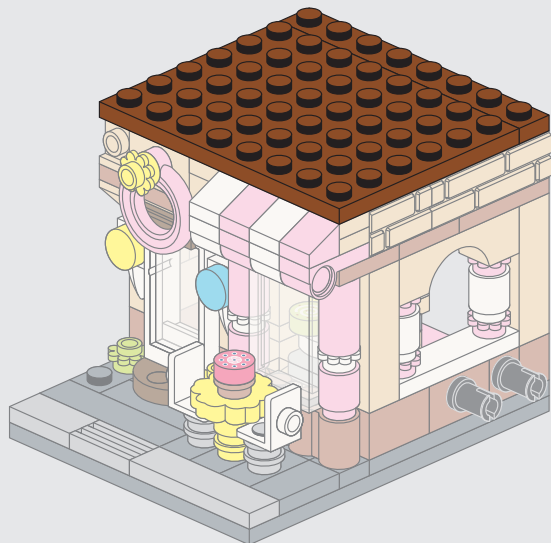

24

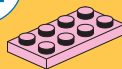

x2



x2



x1



x1

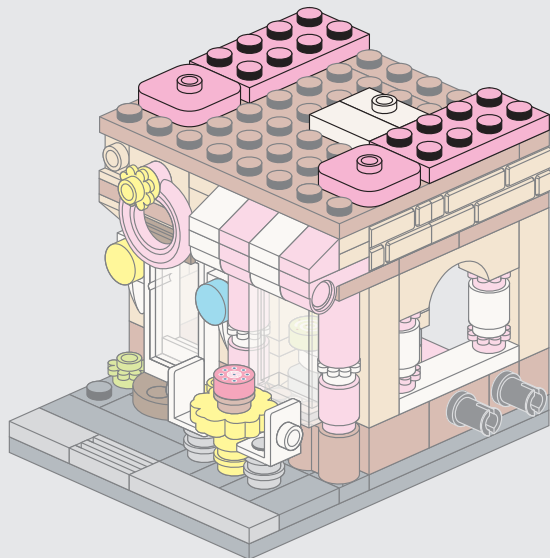

25

A yellow rectangular box containing a list of LEGO parts with their quantities. The parts are: a white 1x3 Technic brick with a hole (x1), a white decorative arch piece (x1), a white 1x2 Technic brick (x1), a pink 1x2 Technic brick (x2), a white 1x2 Technic brick with two holes (x1), a grey 1x2 Technic brick with two holes (shown in a dashed circle with red arrows pointing to the white brick), and a brown 1x2 Technic brick with two holes (x1).



A pink rectangular inset box showing a detailed assembly sequence. It starts with a white 1x3 Technic brick with a hole and a white decorative arch piece. Red arrows indicate the arch piece being inserted into the hole. The next step shows the white brick with the arch piece inserted, and a brown 1x2 Technic brick with two holes being placed underneath it. Red arrows indicate the brick being pushed up to fit under the white brick.

26

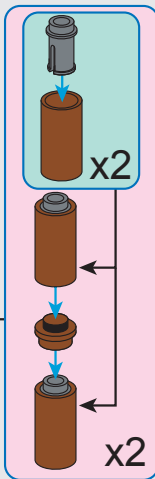
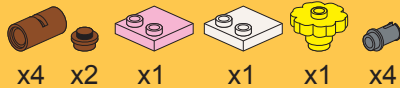

27

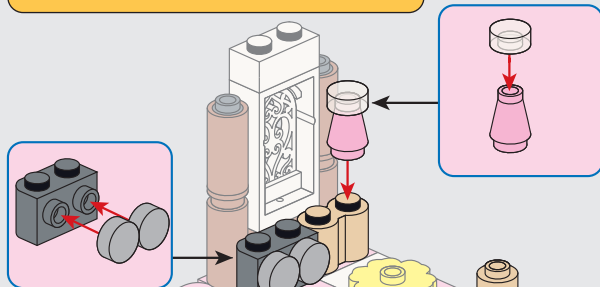
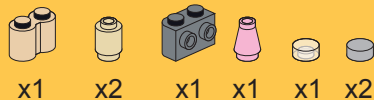

28

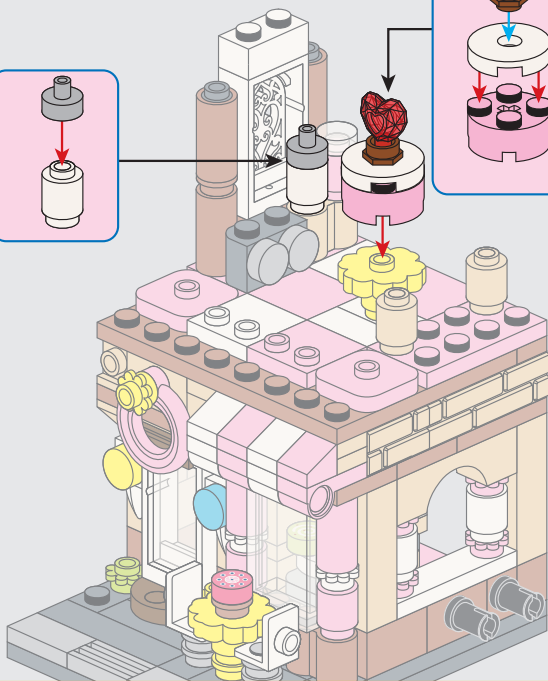
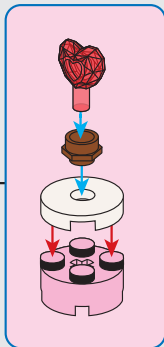
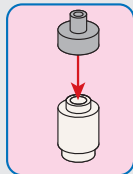
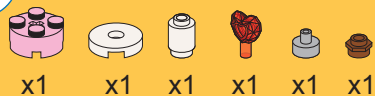

15

29

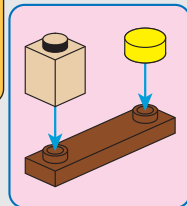
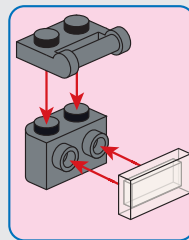
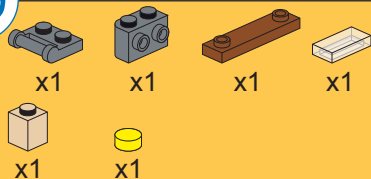

30

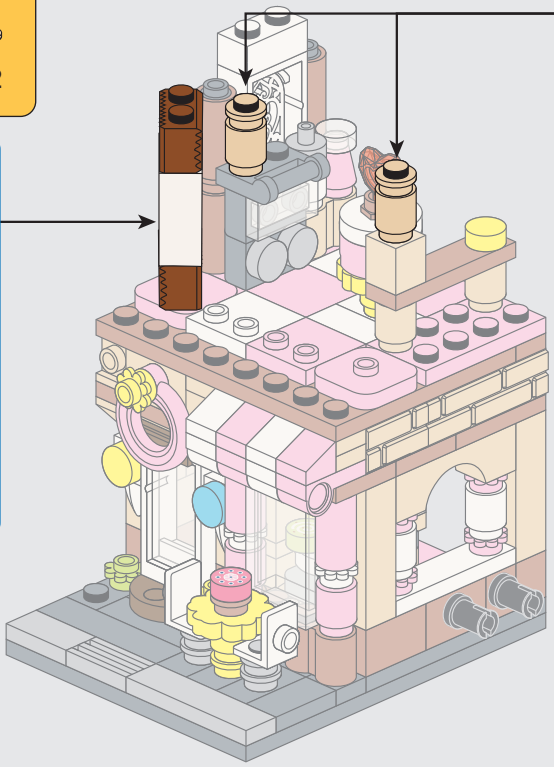
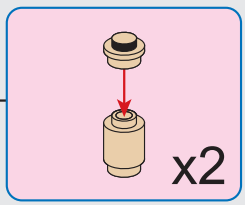
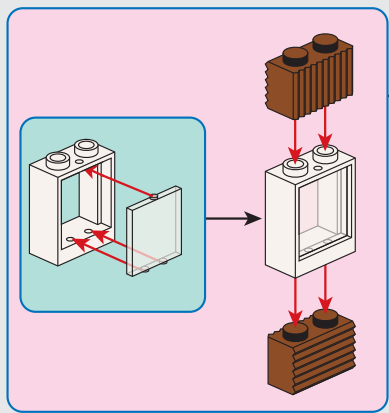
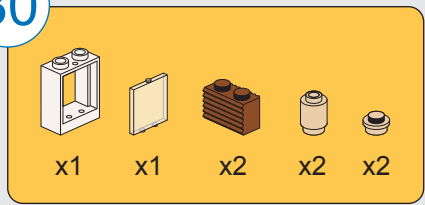

31

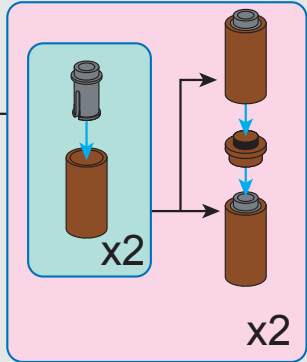
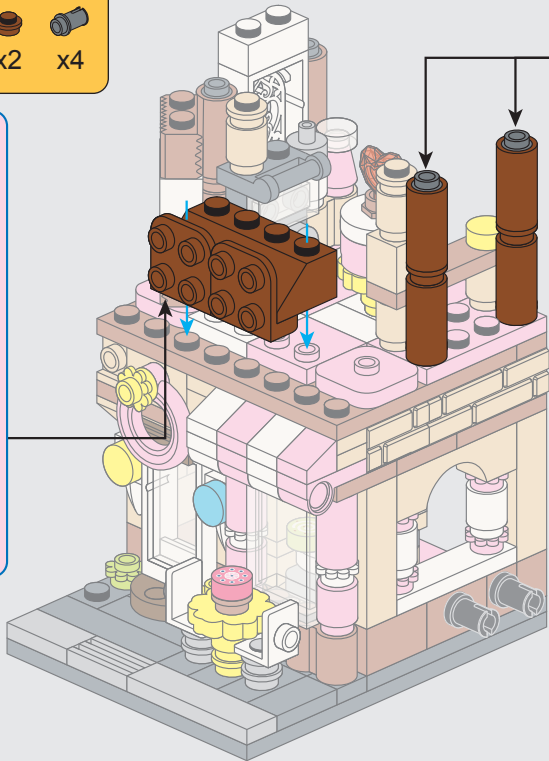
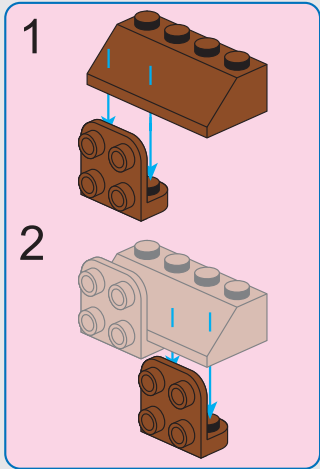
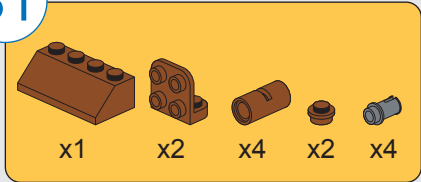

32

Parts list for step 32:

- x1 White 1x3 Technic brick with 2 holes and a central slot
- x1 White 1x3 Technic brick with 2 holes and a central slot, with a hole on the right side
- x1 White 1x3 Technic brick with 2 holes and a central slot
- x2 White 1x3 Technic brick with 2 holes and a central slot, with a decorative pattern
- x2 White 1x3 Technic brick with 2 holes and a central slot, with a hole on the right side
- x1 White 1x3 Technic brick with 2 holes and a central slot, with a hole on the right side
- x3 Brown 1x3 Technic brick with 2 holes and a central slot
- x1 White 1x3 Technic brick with 2 holes and a central slot, with a hole on the right side (shown with a sub-assembly)

Assembly diagram for the sub-assembly:

A white 1x3 Technic brick with 2 holes and a central slot is shown. A brown 1x3 Technic brick with 2 holes and a central slot is being inserted into the top hole of the white brick. A white 1x3 Technic brick with 2 holes and a central slot, with a hole on the right side, is being inserted into the middle hole of the white brick. A brown 1x3 Technic brick with 2 holes and a central slot is being inserted into the bottom hole of the white brick.

Main assembly diagram showing the central structure of the model. A white 1x3 Technic brick with 2 holes and a central slot, with a hole on the right side, is being inserted into the top hole of a white 1x3 Technic brick with 2 holes and a central slot. A brown 1x3 Technic brick with 2 holes and a central slot is being inserted into the bottom hole of the white 1x3 Technic brick with 2 holes and a central slot, with a hole on the right side. A white 1x3 Technic brick with 2 holes and a central slot, with a hole on the right side, is being inserted into the middle hole of the white 1x3 Technic brick with 2 holes and a central slot, with a hole on the right side.

Assembly diagram for the top part: A white 1x3 Technic brick with 2 holes and a central slot, with a hole on the right side, is being inserted into the top hole of a white 1x3 Technic brick with 2 holes and a central slot. A brown 1x3 Technic brick with 2 holes and a central slot is being inserted into the bottom hole of the white 1x3 Technic brick with 2 holes and a central slot, with a hole on the right side.

Assembly diagram for the middle part: A white 1x3 Technic brick with 2 holes and a central slot, with a hole on the right side, is being inserted into the middle hole of a white 1x3 Technic brick with 2 holes and a central slot, with a hole on the right side. A brown 1x3 Technic brick with 2 holes and a central slot is being inserted into the bottom hole of the white 1x3 Technic brick with 2 holes and a central slot, with a hole on the right side.

Assembly diagram for the bottom part: A white 1x3 Technic brick with 2 holes and a central slot, with a hole on the right side, is being inserted into the top hole of a white 1x3 Technic brick with 2 holes and a central slot, with a hole on the right side. A brown 1x3 Technic brick with 2 holes and a central slot is being inserted into the bottom hole of the white 1x3 Technic brick with 2 holes and a central slot, with a hole on the right side.

33

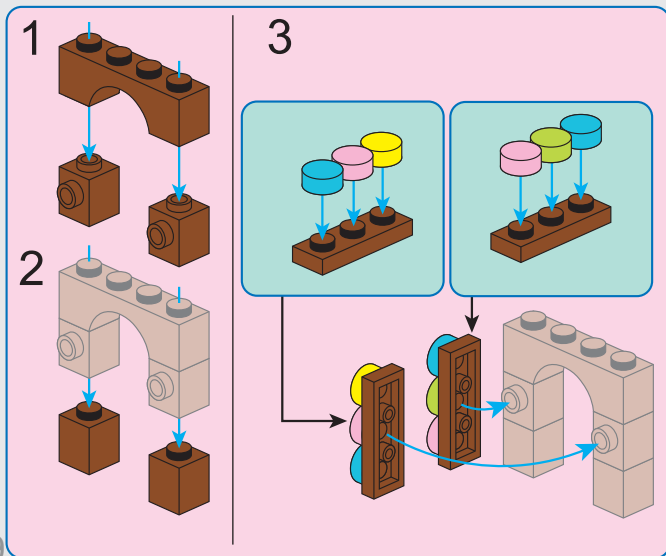
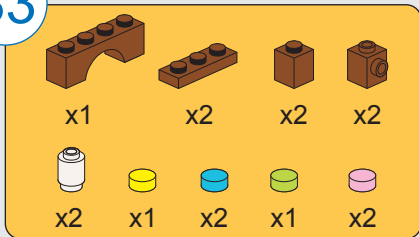

34

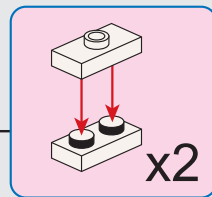
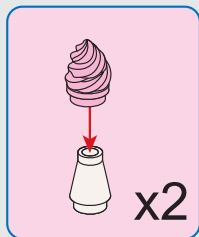
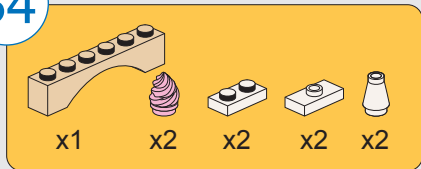

35

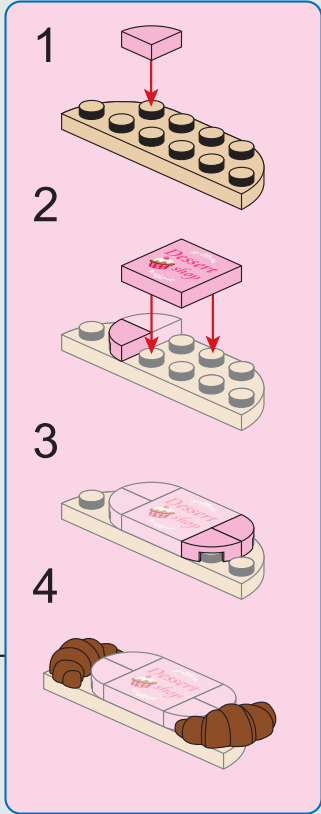
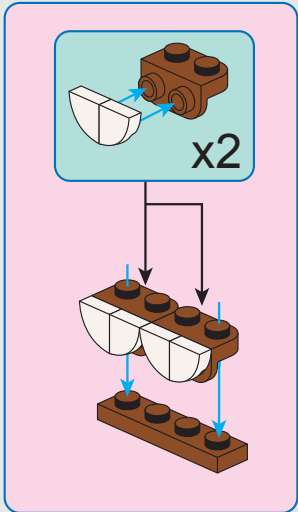
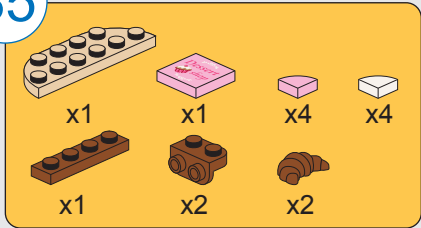

36

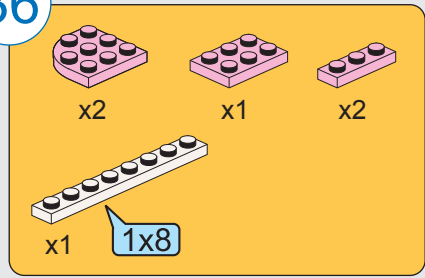

x2

x1

x2

x1

1x8

This block contains a parts list for step 36. It features four items: two 2x4 pink plates, one 2x4 pink plate, two 1x3 pink plates, one 1x8 white Technic beam, and a blue callout box containing the text '1x8'.



37

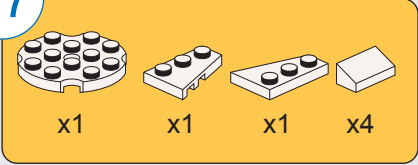

A yellow rectangular box containing a list of four LEGO parts with their respective quantities. From left to right: a white 1x6 round plate with 12 holes (x1), a white 1x2 Technic brick with two holes (x1), a white 1x3 Technic brick with three holes (x1), and a white 1x1 Technic brick (x4).



38

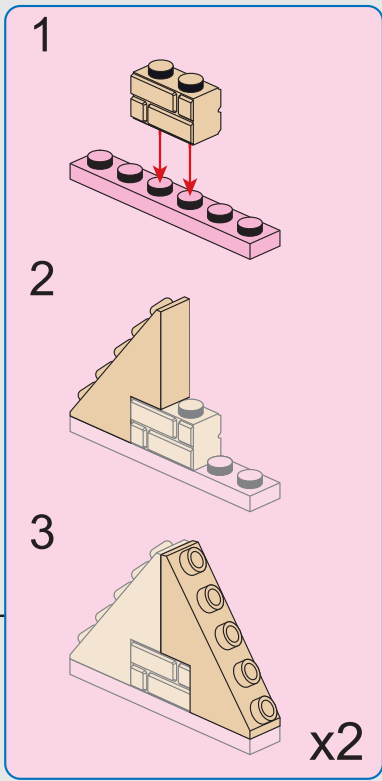
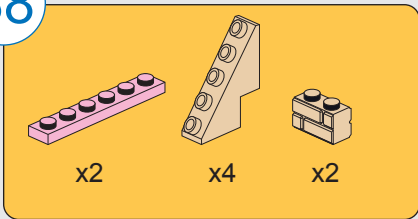

39

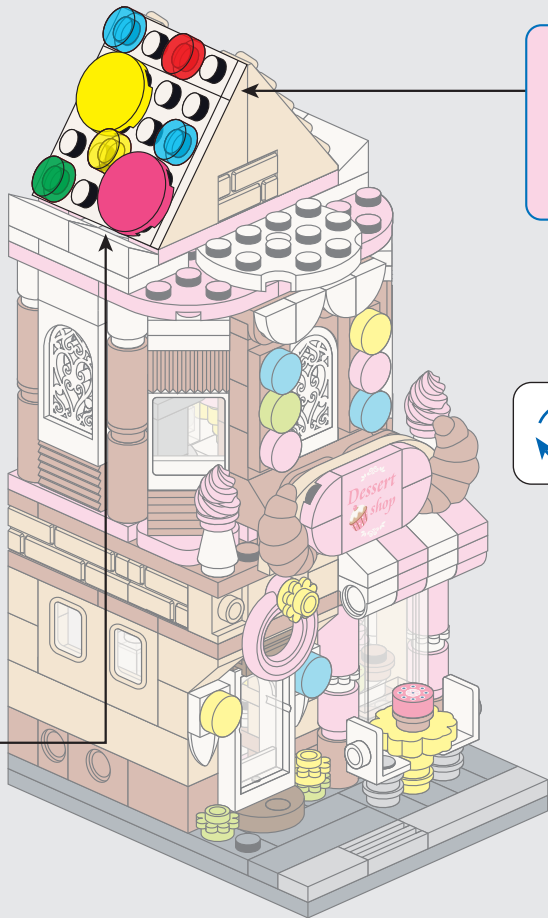
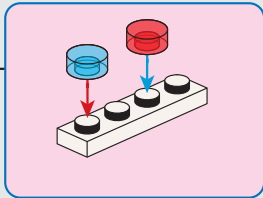
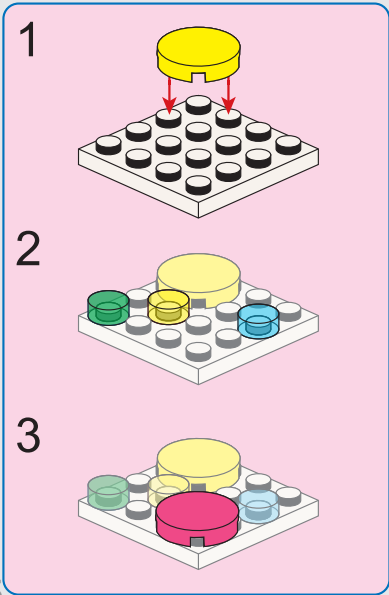
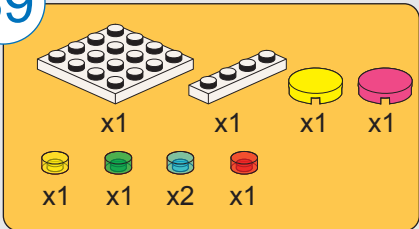



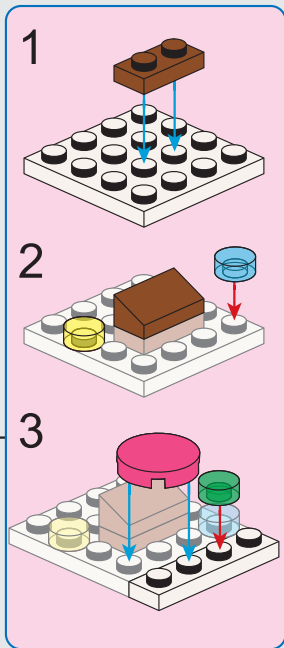
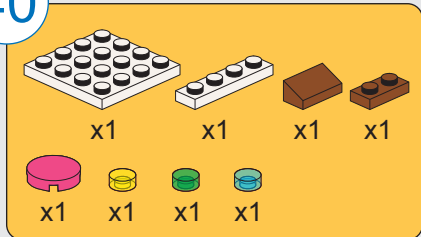

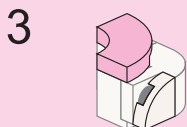
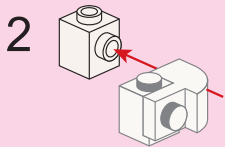
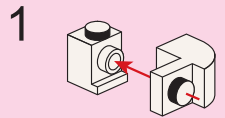
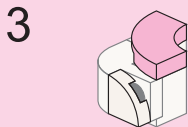
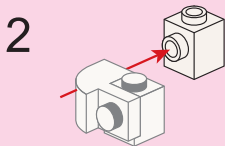
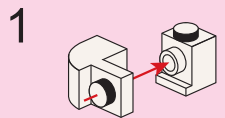
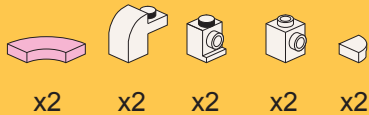

40



41



42

			
x1	x1	x1	x1
			
x2	x1		



1

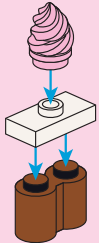

2

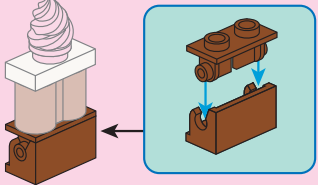

43

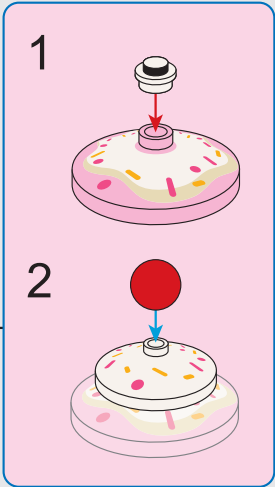
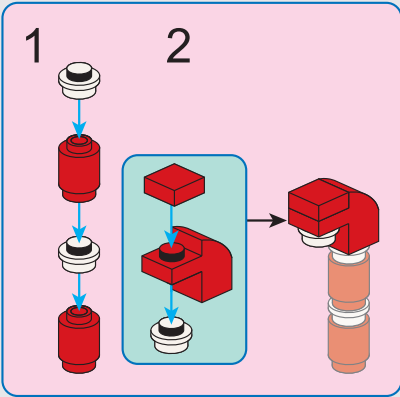
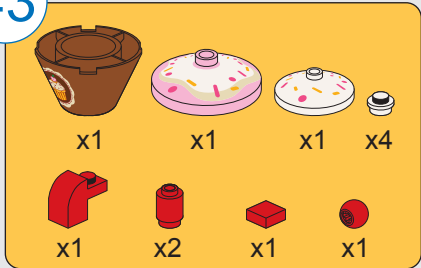

44



x1



x1



x1

3



x1

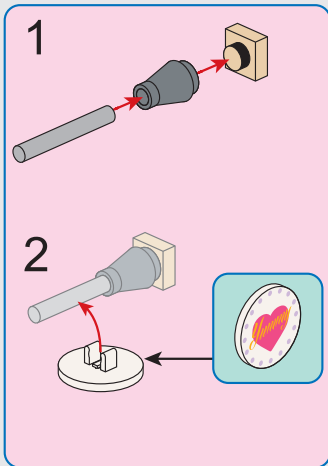

Dessert Shop Instructions

› 3 designs to collect



Juice Bar



Dessert Shop



Flower Shop

Juice Bar Instructions

6+
years



Building
Series

324
PIECES

Difficulty Level

 **WARNING:** CHOKING HAZARD
SMALL PARTS. NOT FOR CHILDREN UNDER 3 YEARS.

1

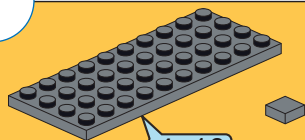

x1

4x10

x1

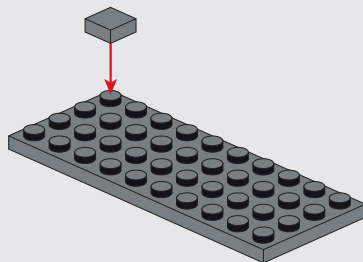

2



x2

x1

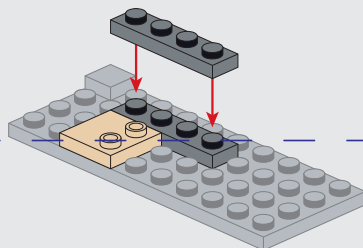

3

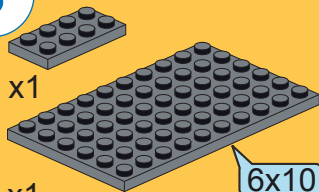

x1

6x10

x1

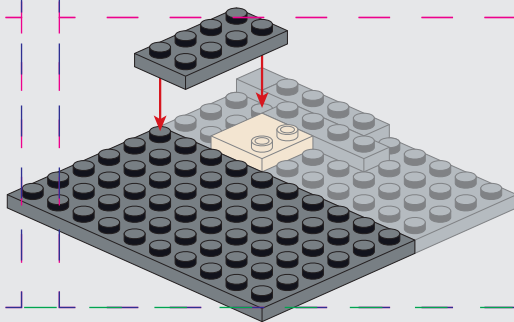

1

4



x1



x1



x2



x2



x1

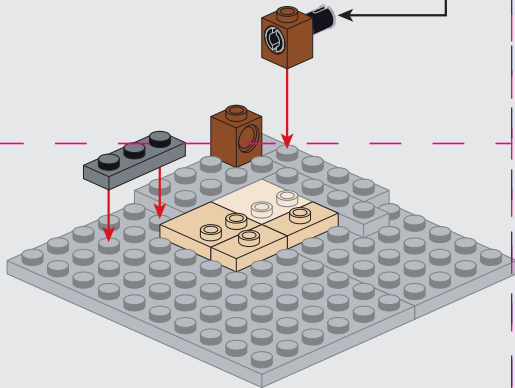
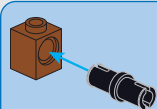

5



x2



x1



x1

1x3



x2

1x4



x1



x1

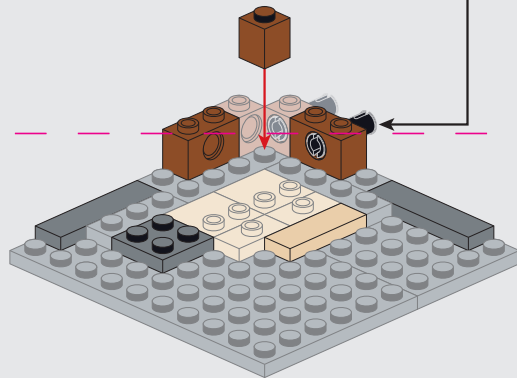
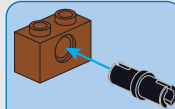

6

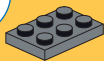

x1



x2



x2

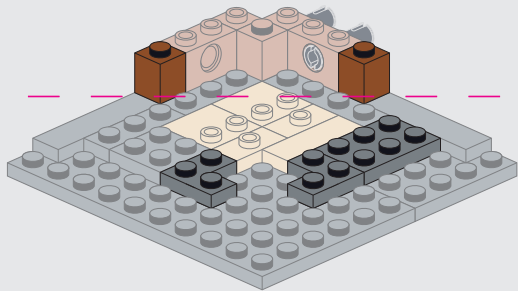

7



x2



x1

1x3



x1



x2



x1



x1

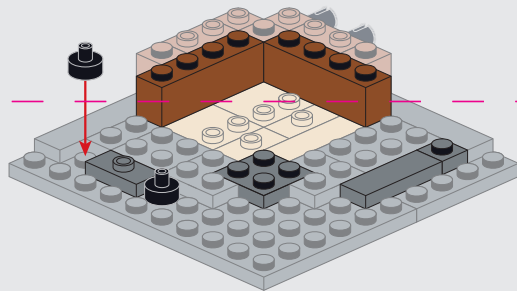

8



x1



x1



x2

1x3



x2



1:1

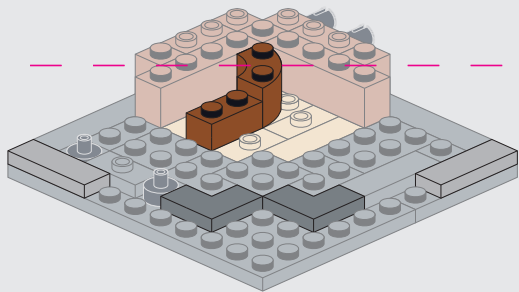

9



x1



x4



x2



x2



x2



x2



x2

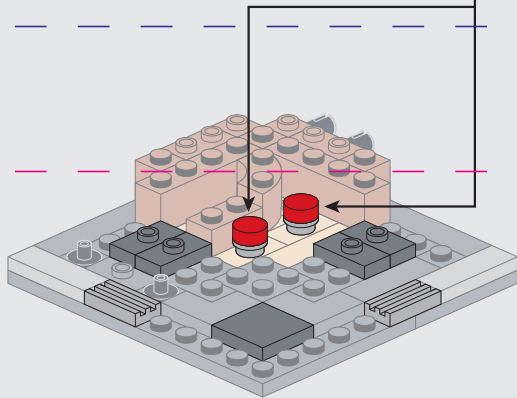

10

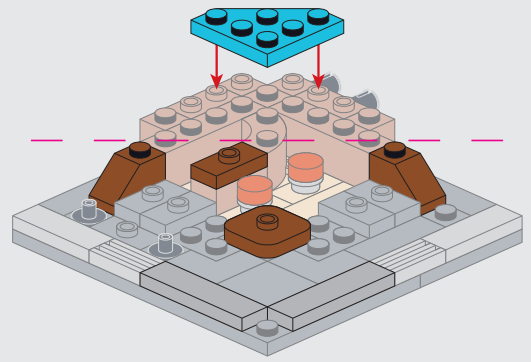
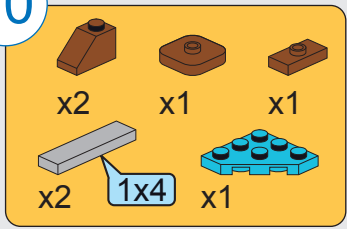

11

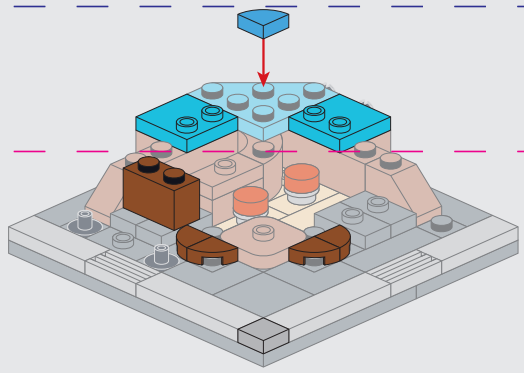
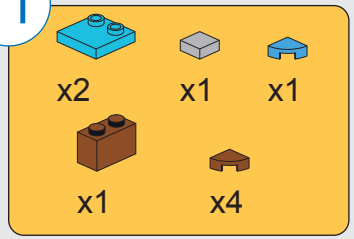

12

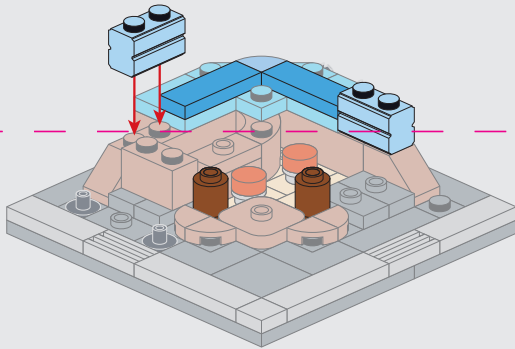
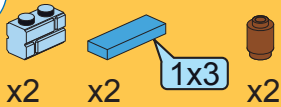

13

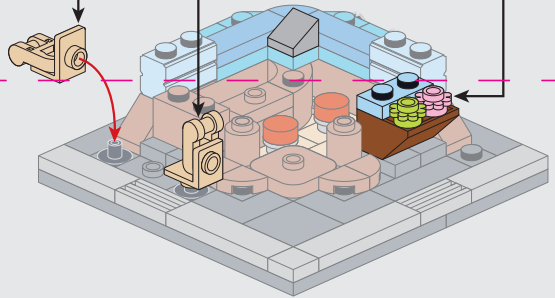
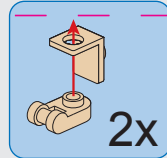
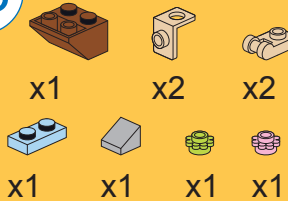

14



x1



x1



x2



x1

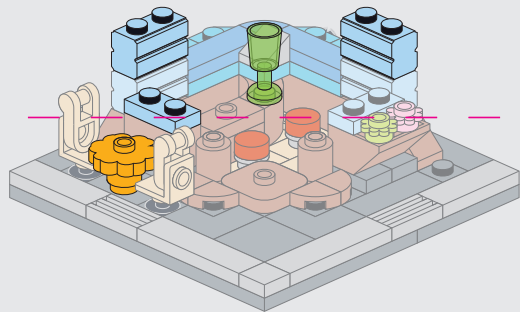

15



x2



x1



x1



x1



x1



x1

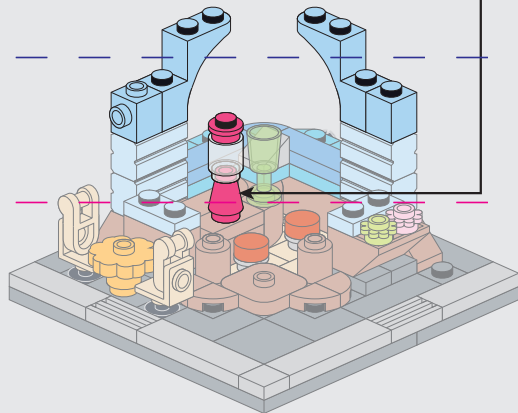
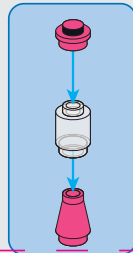

16

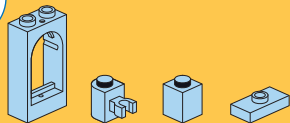

x1 x1 x1 x1



x1 x1 x1 x1

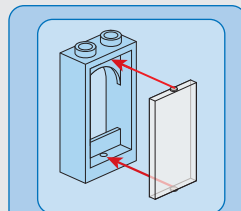
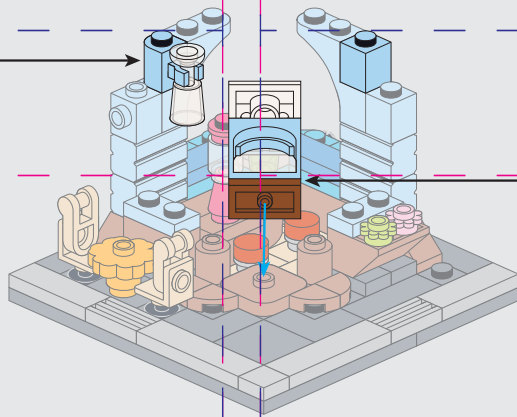
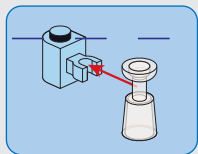

1

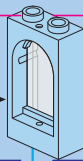

2



17



x1



x1



x2



x1

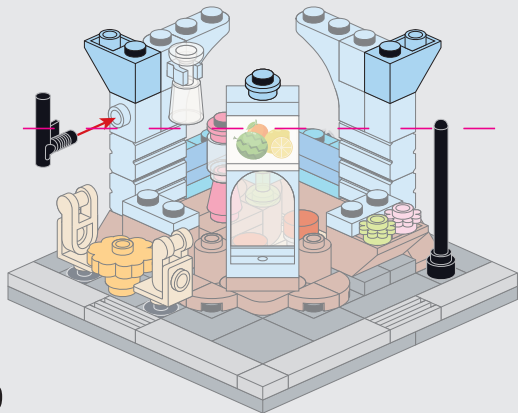

9

18



x2



x2



x1



x1

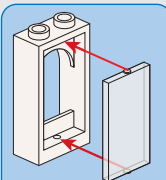

x2

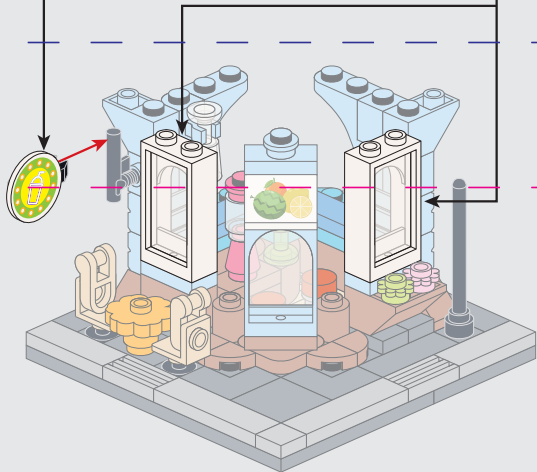
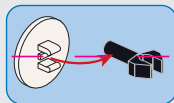

19



x4



x2

1

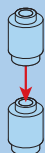

2

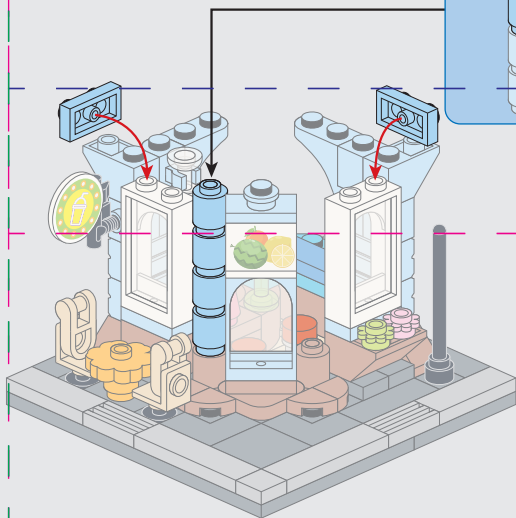

20



x2



x2



x3



x1



x3



x1

1

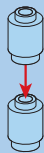

2



3

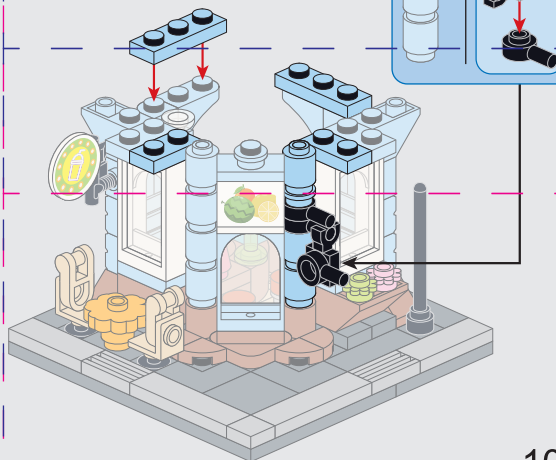

21

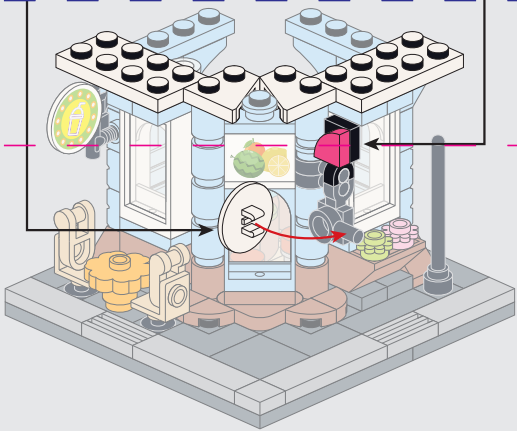
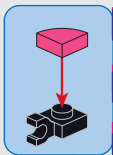
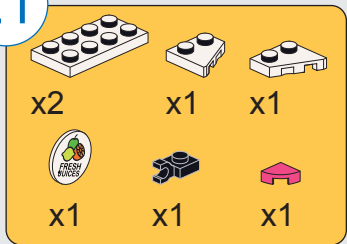

22

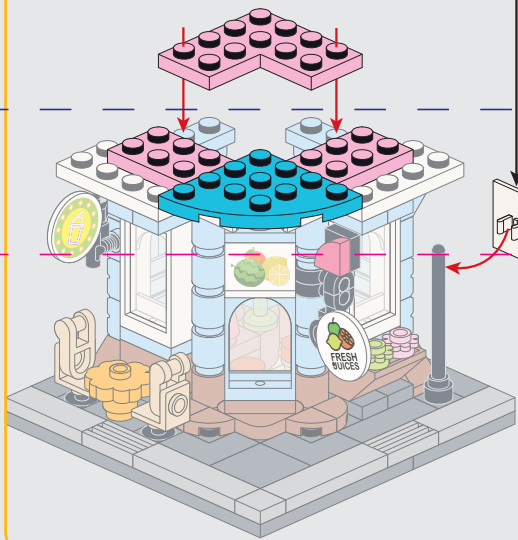
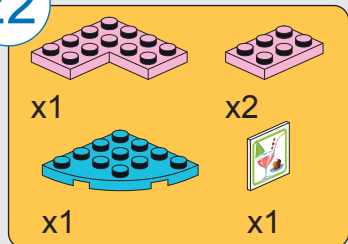

23



x2



x2



x1

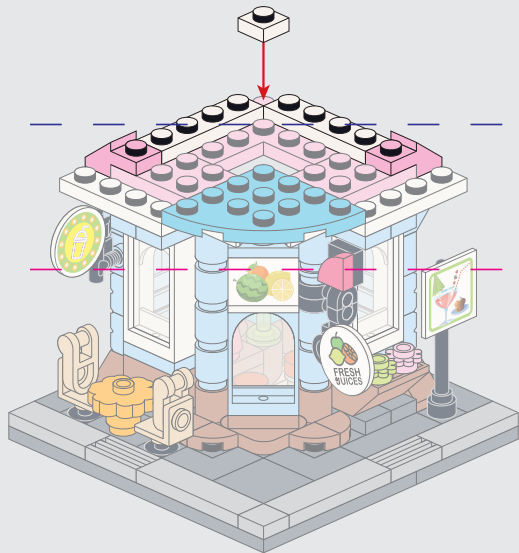

24

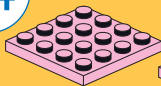

x1



x2



x1

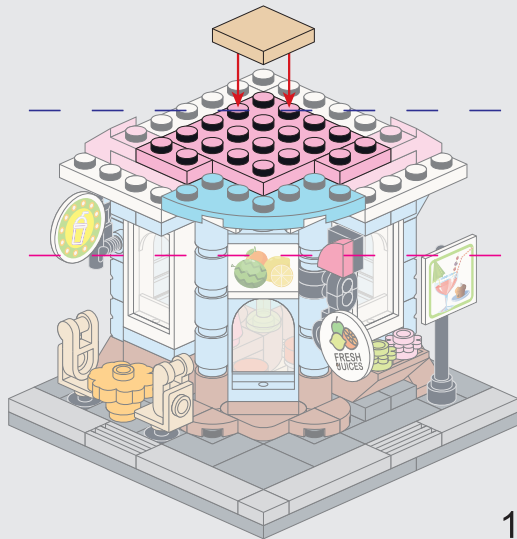

25

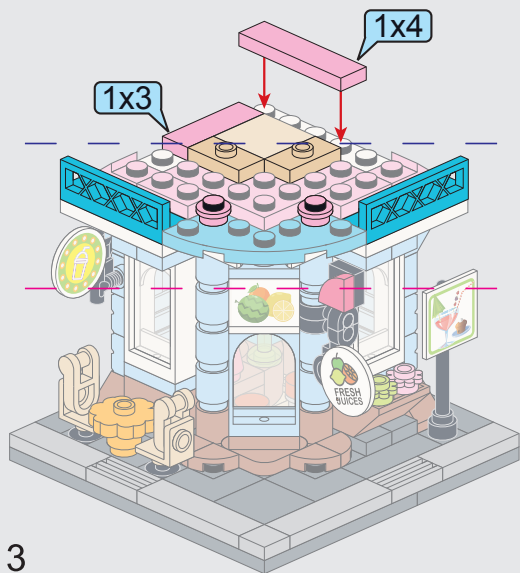
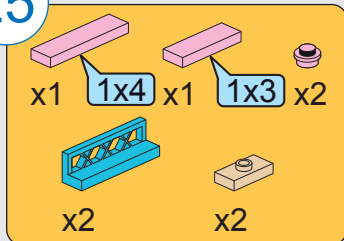

13

26

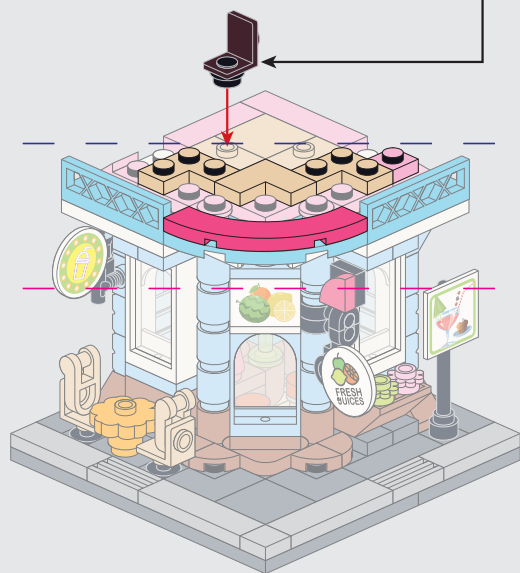
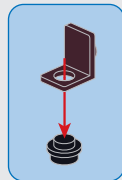
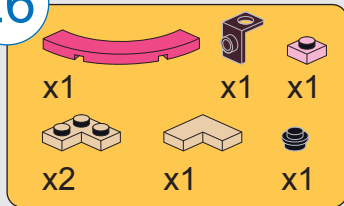

27

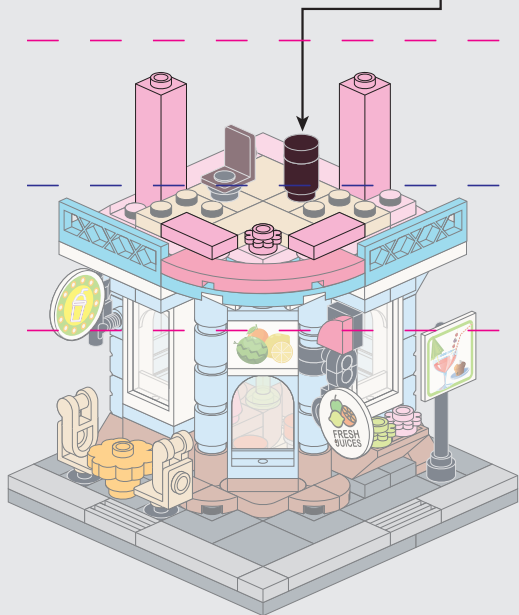
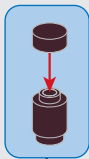
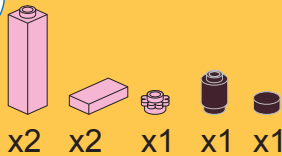

28

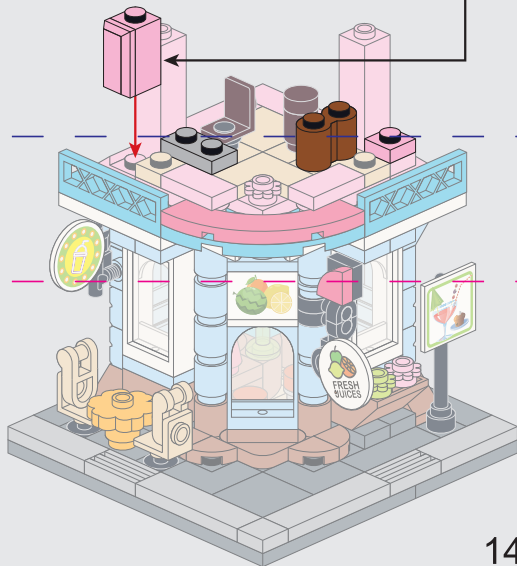
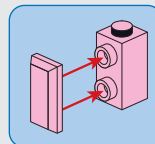
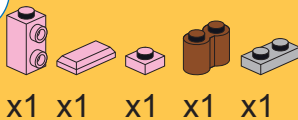

29



x1 x1 x1 x1 x1

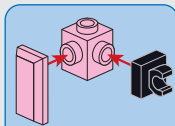

15

30



x2 x1 x1 x2 x2

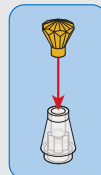
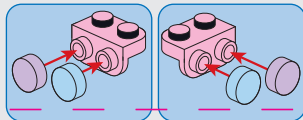

31

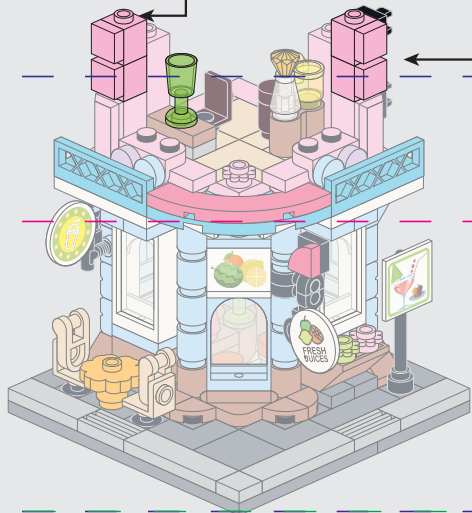
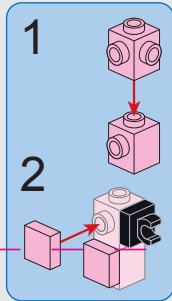
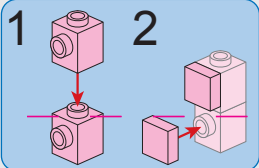
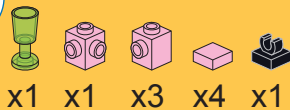

32

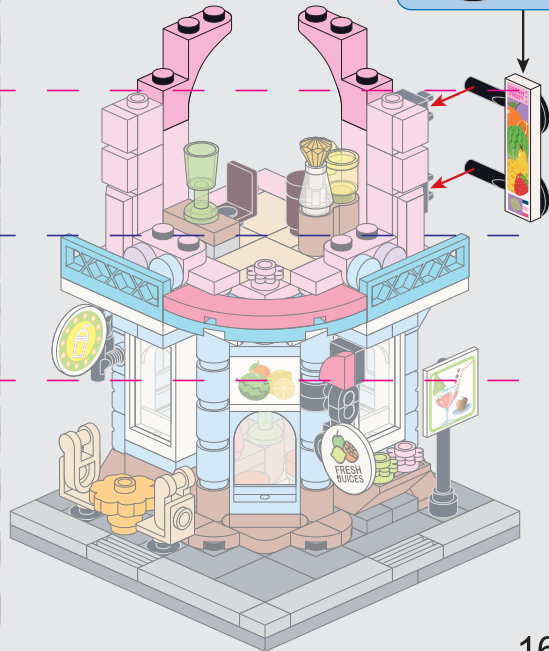
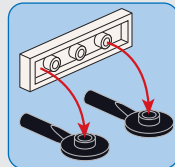
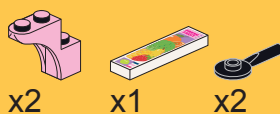

33

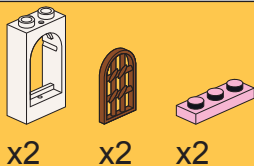

x2

x2

x2

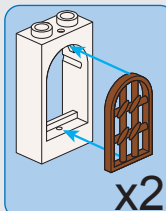

x2



34



x1



x1

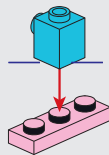

35



x1



x2

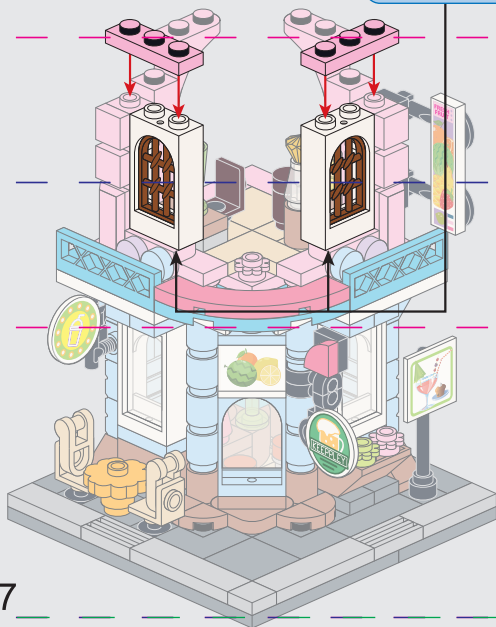
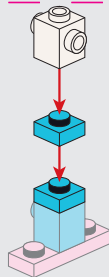

36



x2

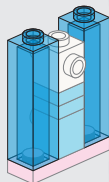

37



x1



x1

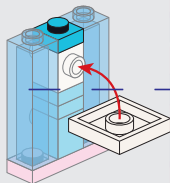

38



x1



x1

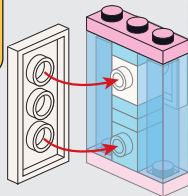

39



x2



x1



40



x1



x1

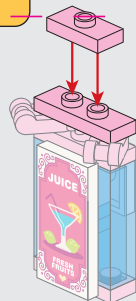

41



x2

40

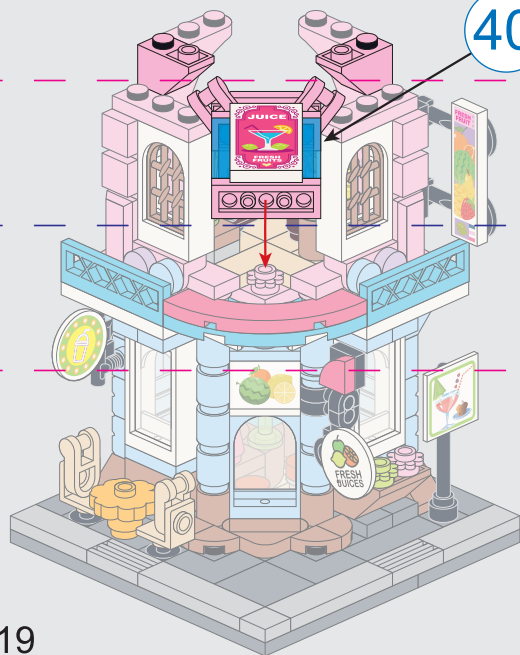

19

42



x2



x2



43



x2



x1



x1

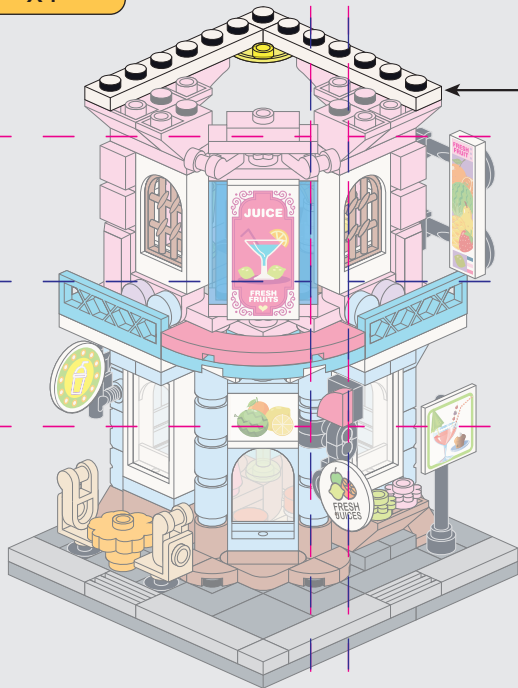

1

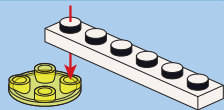

2

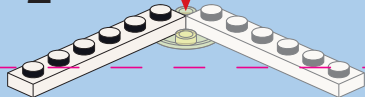

44



x1



x2

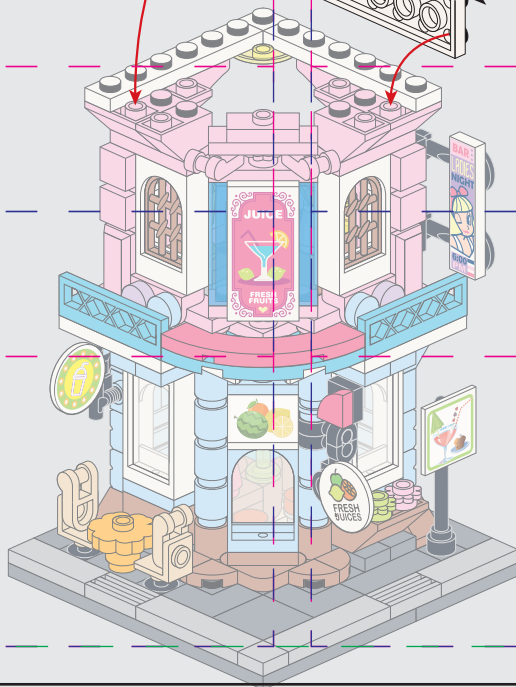
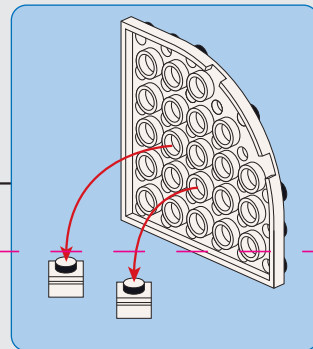
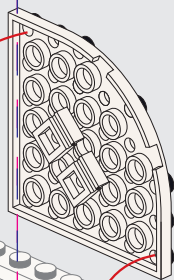

45



x1



x1



x1

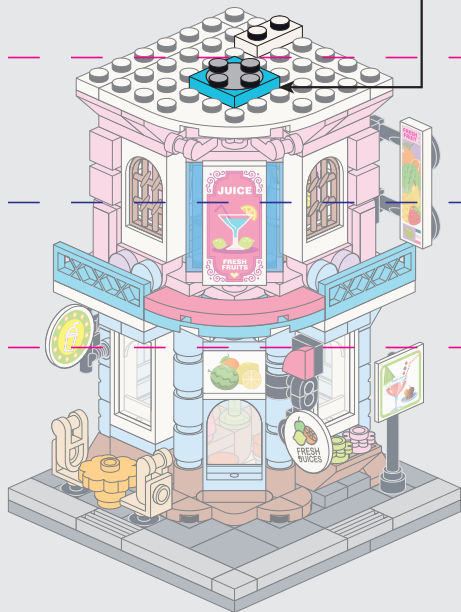
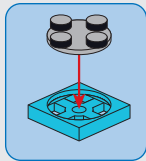

46



x1



x4

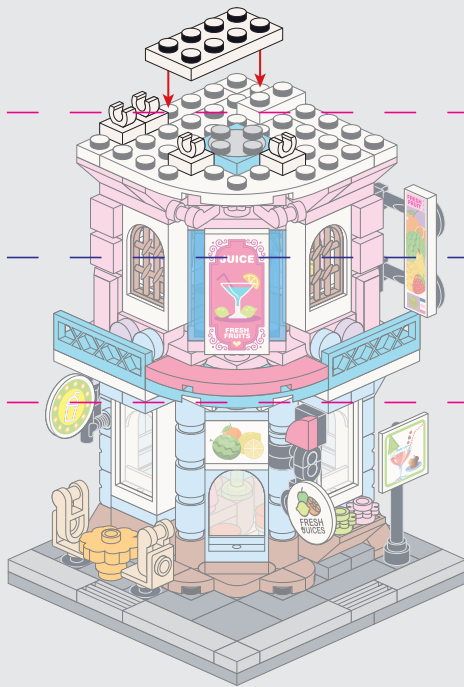

47



x1



x1



x1

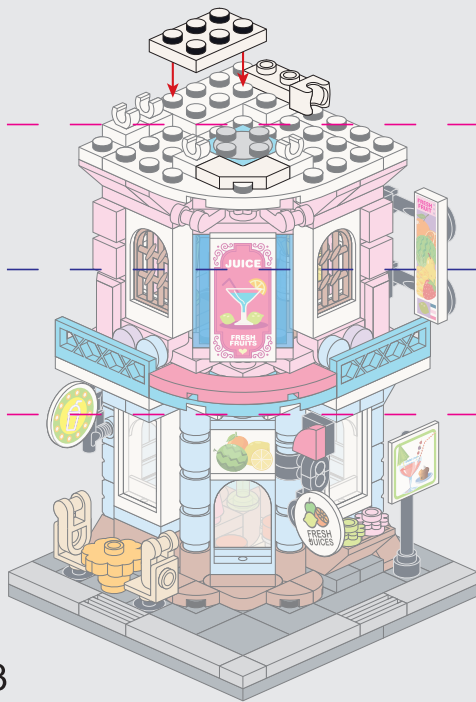

23

48



x1



x1



x1

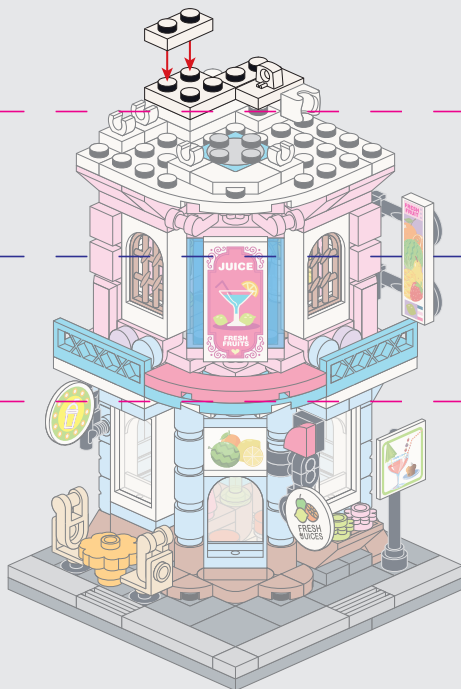

49

		
x1	x1	x1
		
x1	x2	x1
		
x1	x1	x1

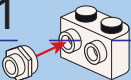
1 

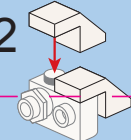
2 

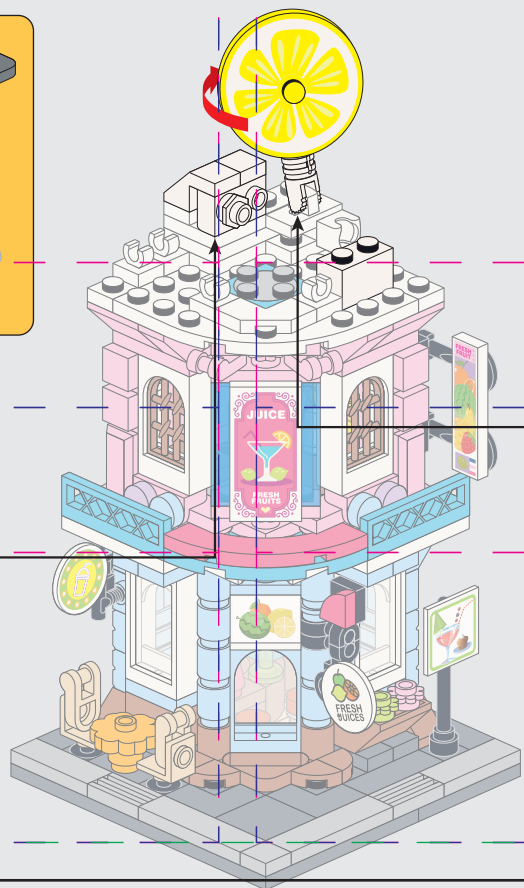

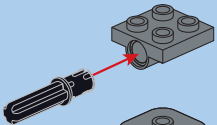
1 

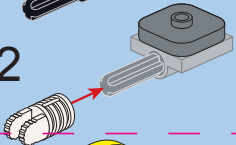
2 

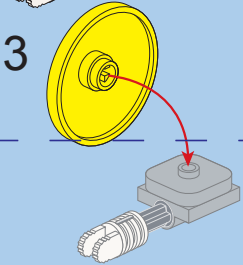
3 

50

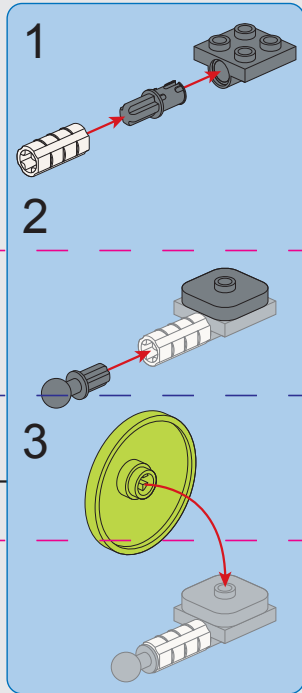
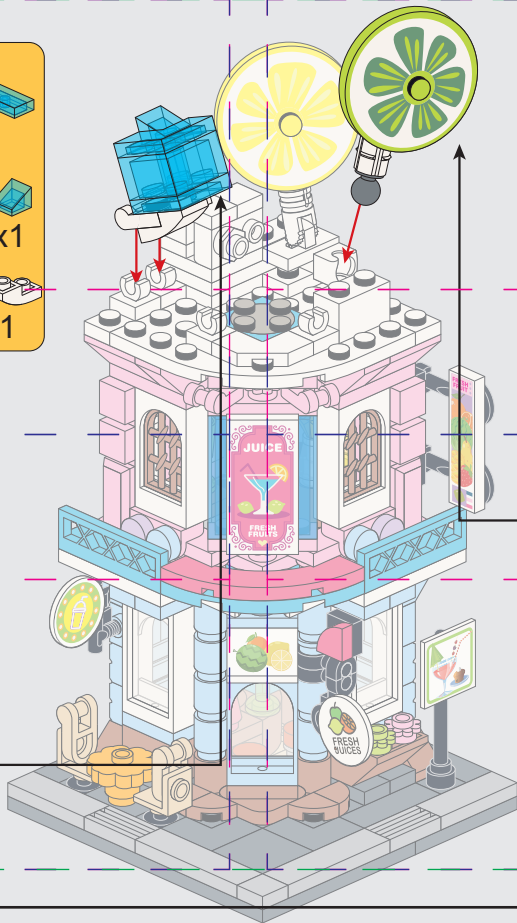
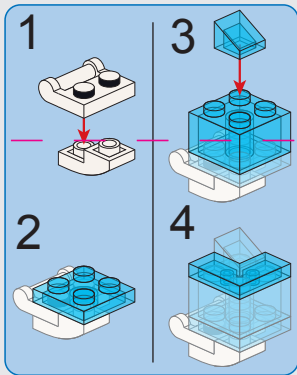

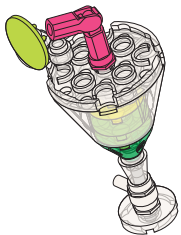

51

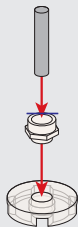

52

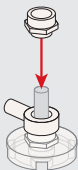

53

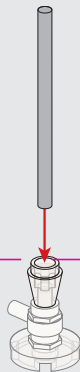
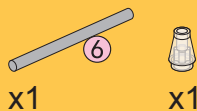

54

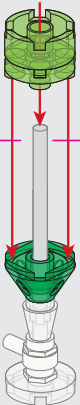
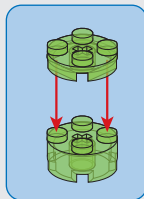

55



x1



x1

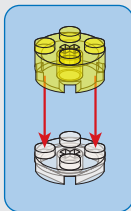

56

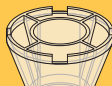

x1



x1

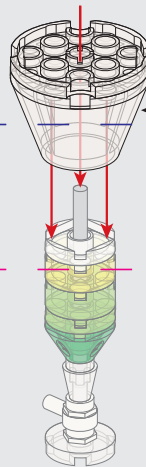
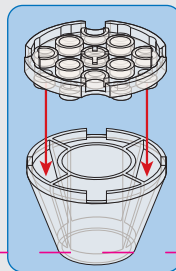

57



x1



x1



x1



x1



x1



x1



1



2

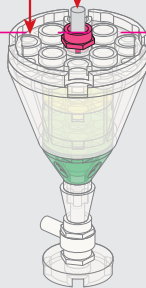
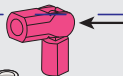

58

57

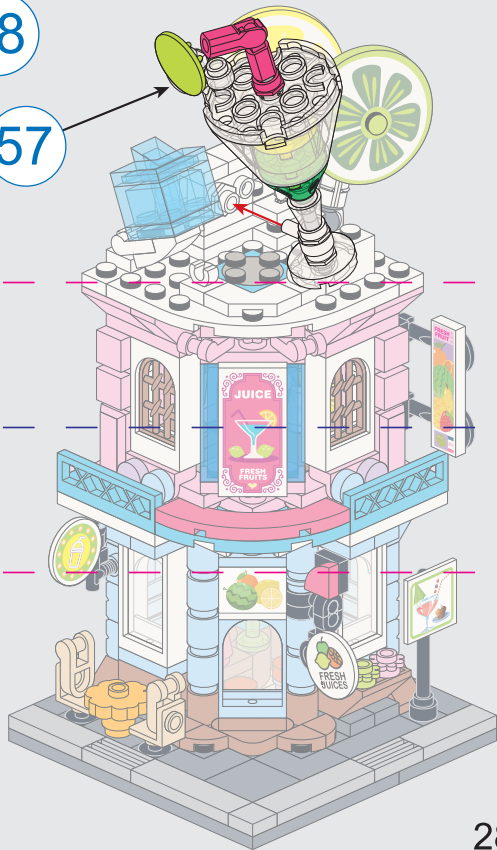

28

59

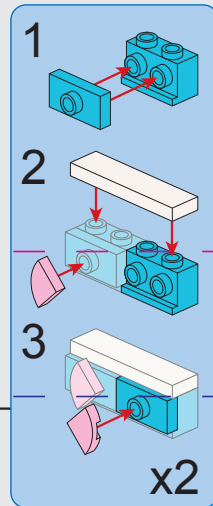
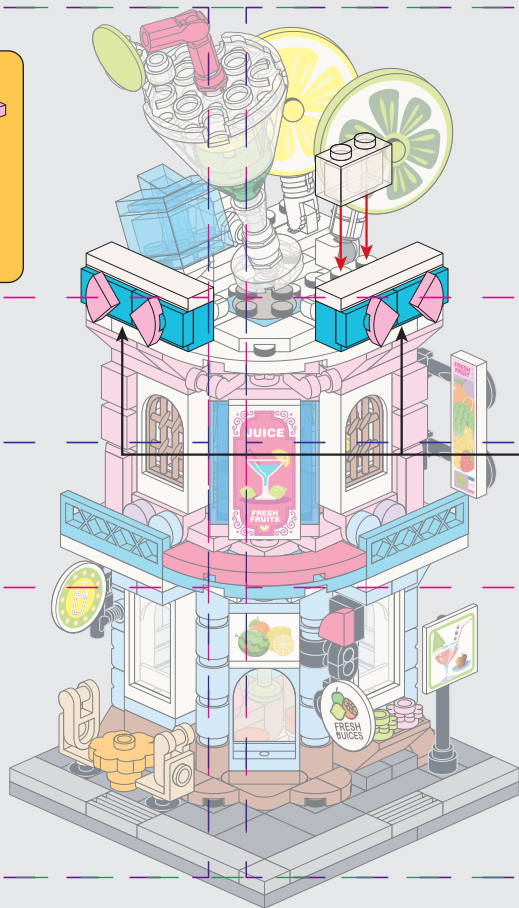
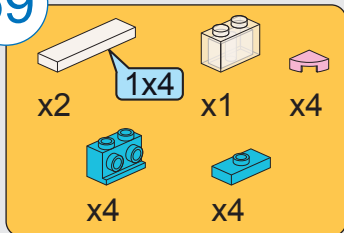

60

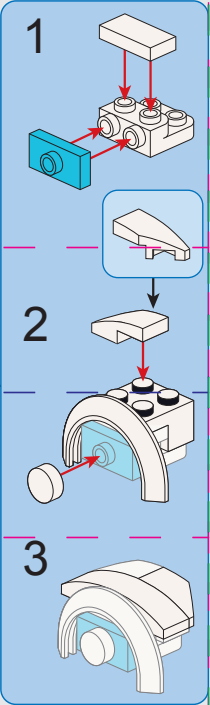
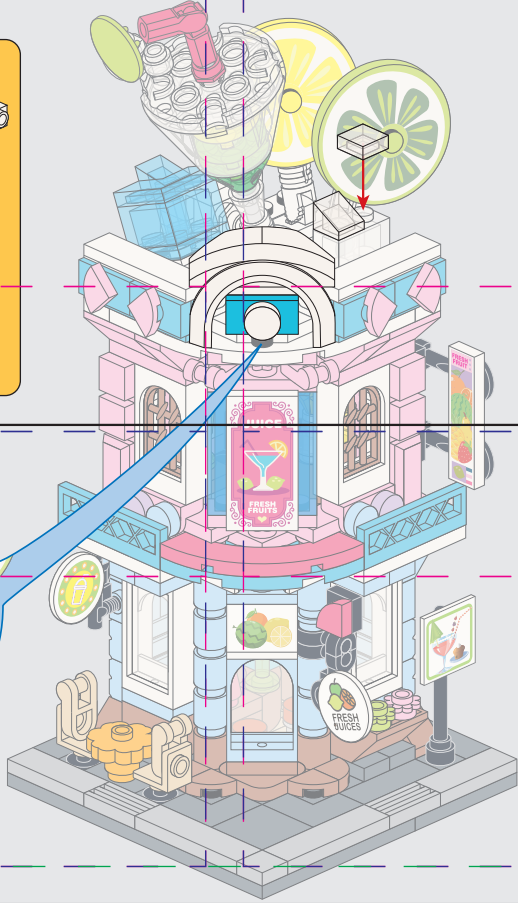
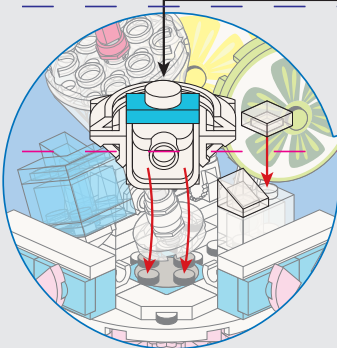

Juice Bar Instructions

› 3 designs to collect



Juice Bar



Dessert Shop



Flower Shop