

Assembly Instructions

43393978 LEVI BEDSIDE TABLE

CARE INSTRUCTIONS:









WIPE CLEAN WITH A SOFT DAMP CLOTH. NEVER USE SCOURERS, ABRASIVES OR CHEMICAL SOLVENTS. KEEP AWAY FROM MOISTURE AND DIRECT SUNLIGHT. STORE IN A DRY PLACE. FOR INDOOR USE ONLY.

WARNING:

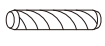











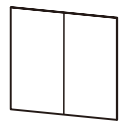

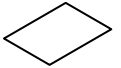

DO NOT STAND, SIT OR LEAN ON THE UNIT. DO NOT USE THIS UNIT AS A STEP LADDER. ENSURE THIS UNIT IS USED ONLY ON A FLAT SURFACE. DO NOT USE THIS UNIT UNLESS ALL BOLTS AND SCREWS ARE FIRMLY SECURED. DO NOT PLACE HOT OBJECTS SUCH AS COFFEE CUPS DIRECTLY ON THE SURFACE OF THIS FURNITURE ITEM. THIS ITEM IS FOR STORAGE PURPOSES ONLY. CONTAINS SMALL PARTS. IT IS TO BE ASSEMBLED BY AN ADULT. FAILURE TO FOLLOW THESE WARNINGS COULD RESULT IN SERIOUS INJURY.

MAXIMUM SAFE LOAD: TOP:10KG: DRAWER: 5KG.

1 Hardware List

	A		17pcs		B		17pcs		C	Ø6x30mm	10pcs
	D	M4x12mm	32pcs		E	M4x35mm	12pcs		F		4pcs
	G	M6x10mm	8pcs		H	M4mm	1pc				

2 Parts List

	1pc		1pc		1pc		1pc		1pc
	2pcs		2pcs		2pcs		2pcs		2pcs
	4pcs		1pc		2pcs		2pcs		2pcs
	2pcs		1pc						

3

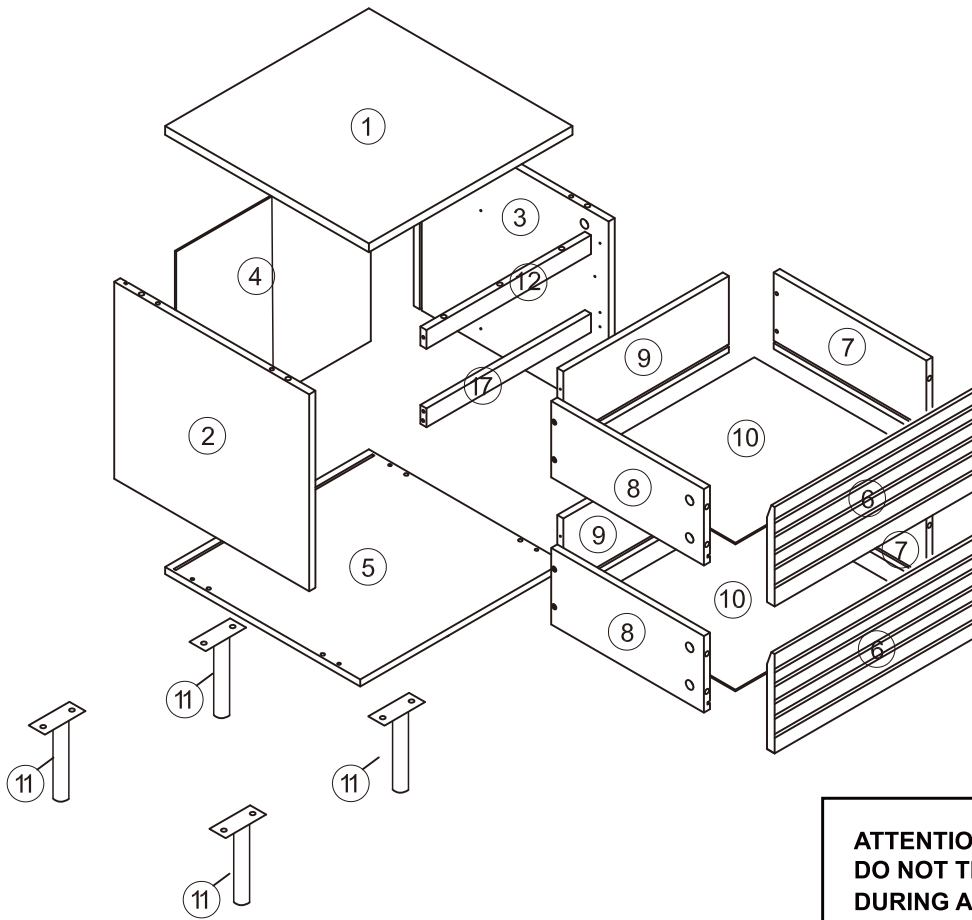

ATTENTION:
DO NOT TIGHTEN THE SCREWS FULLY DURING ASSEMBLY. FULLY TIGHTEN SCREWS AFTER THE FINAL ASSEMBLY STEP.

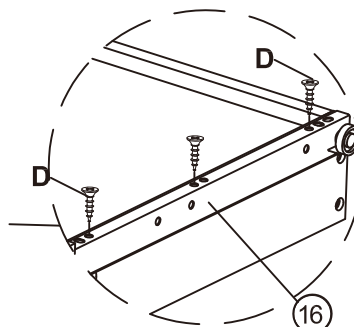
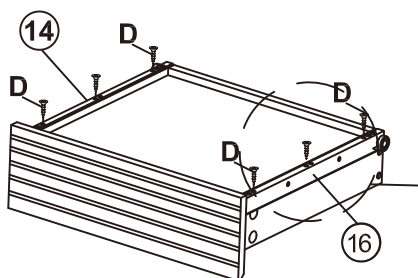
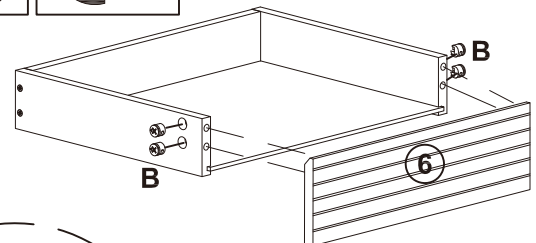
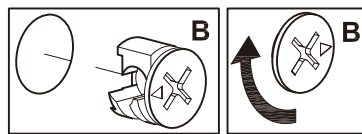
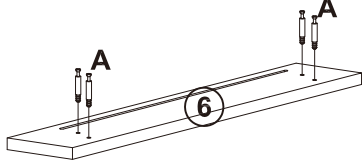
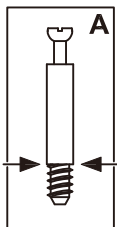
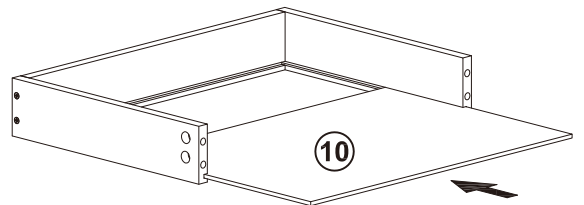
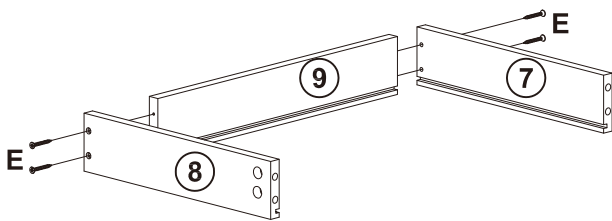

STEP 1 A - x 8 B - x 8 D - x 12 E - x 8





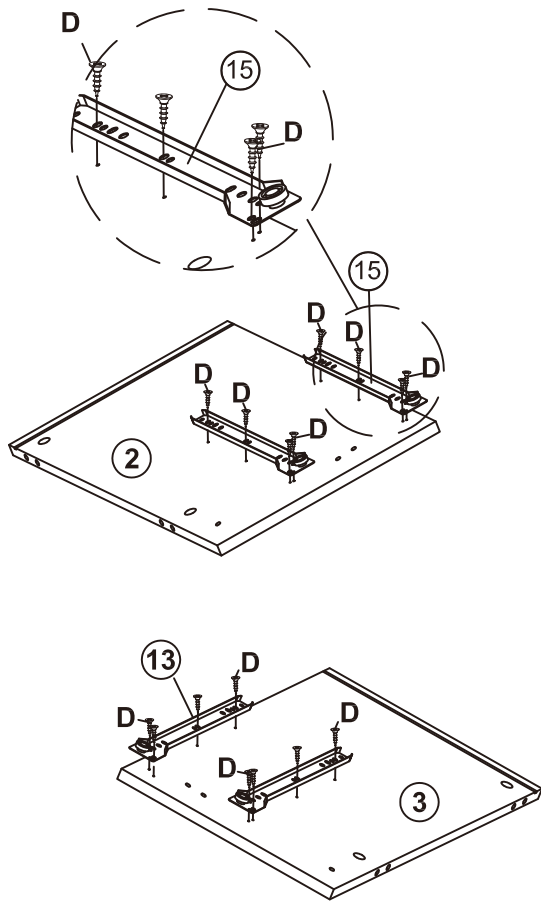

X2

STEP 2 **D -  x 16**

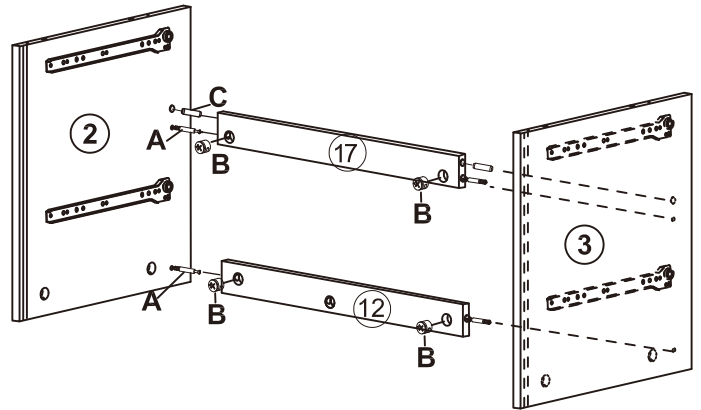

STEP 3 **A -  x 4** **B -  x 4** **C -  x 2**



STEP 4 **A -  x 5** **B -  x 5** **C -  x 4**

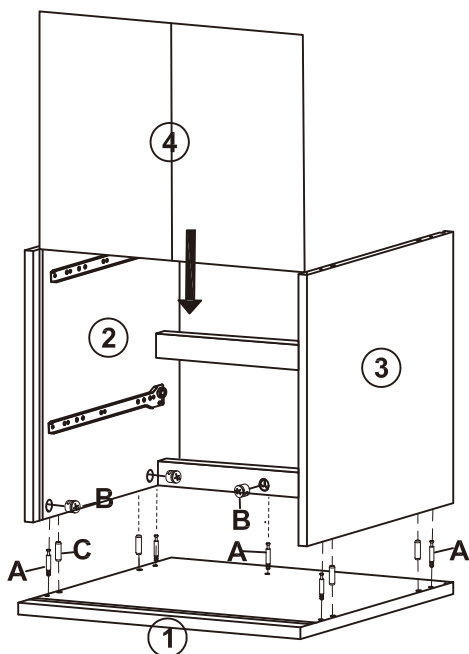

STEP 5 **C -  x 4** **E -  x 4**

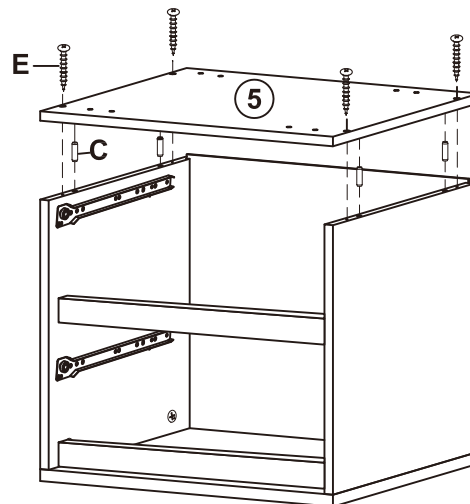

STEP 6 G -  x 8 H -  x 1

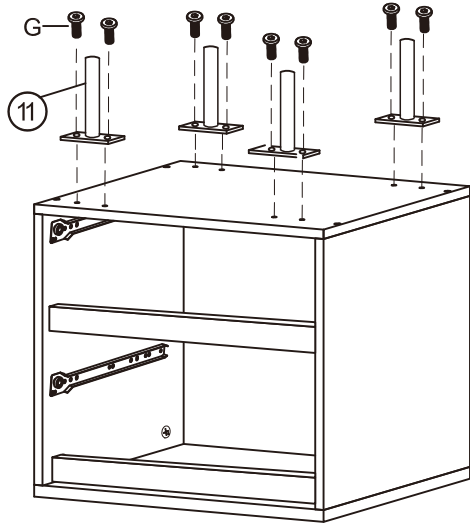

STEP 7 D -  x 4 F -  x 4

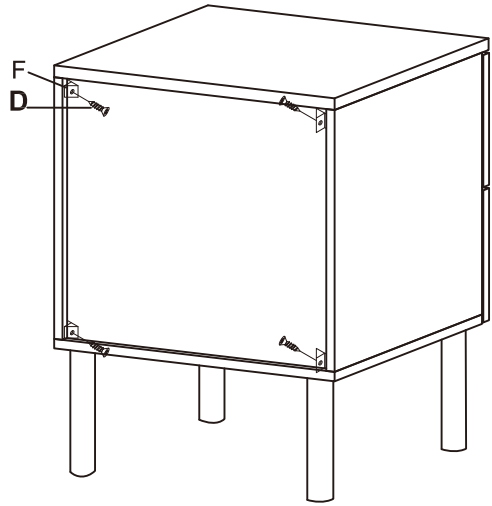

STEP 8

