

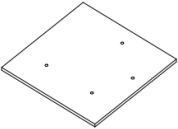











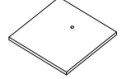
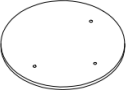
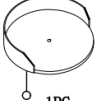



anko

## Cat Tower 3 Tier



## Contents

1  1PC SIZE 390mm*390mm*12mm	2  1PC SIZE 290mm*290mm*12mm	3  1PC SIZE 290mm*290mm*12mm	4  1PC	5  1PC SIZE 240mm*240mm*12mm
6  1PC SIZE 390mm*390mm*12mm	7  1PC	8  1PC	9  2PCS SIZE 200mm	10  1PC SIZE 150mm
11  1PC SIZE 300mm	12  1PC SIZE 250mm	13  1PC SIZE 250mm	14  2PCS SIZE 185mm	15  1PC

Accessory	Size	Quantity
A 	8mm*80mm	2pcs
B 	8mm*35mm	11pcs
	5mm	1pc

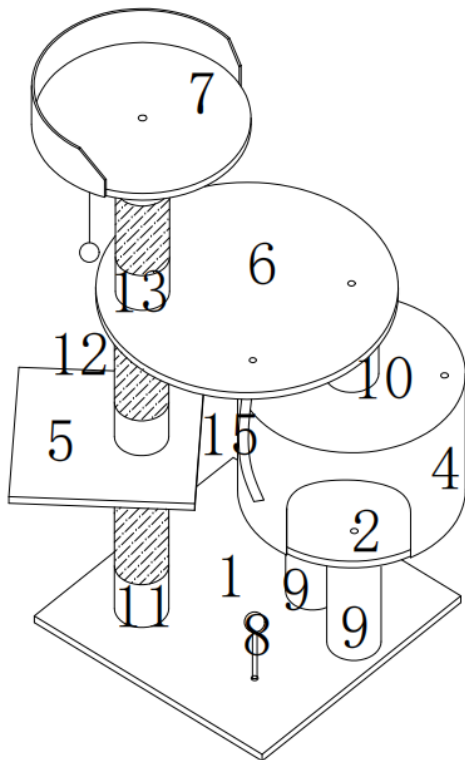

## Instructions

### Step 1.

Screw poles No.14 to board No.2 and No.3, using B screws and provided allen key. Place the cover (No.4) over board No.2, creating a soft cave. Refer to image below:

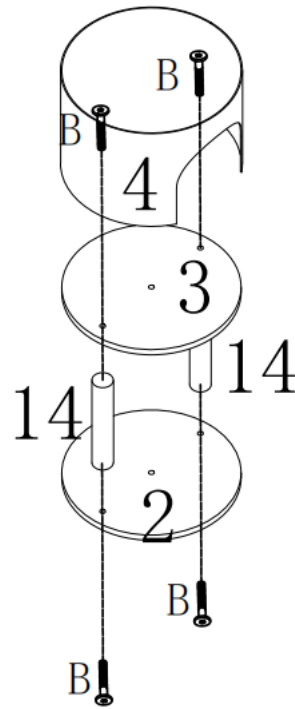

Put this aside for now.

### Step 2.

Screw poles No.9 and No.11 to board No.1, using the allen key and B screws.

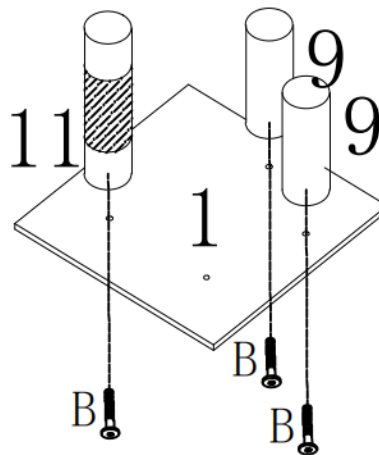

**Step 3.**

Insert screw A into pole No.11, then attach board No.5 onto screw A. Screw pole No.12 onto the top of board No.5 with screw A.

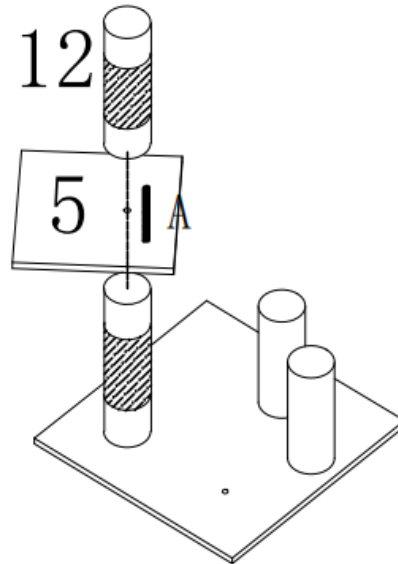

**Step 4.**

Attach soft cave to poles No.9, by using B screws and provided allen key. Screw pole No.10 onto the cave, using B screws and provided allen key.

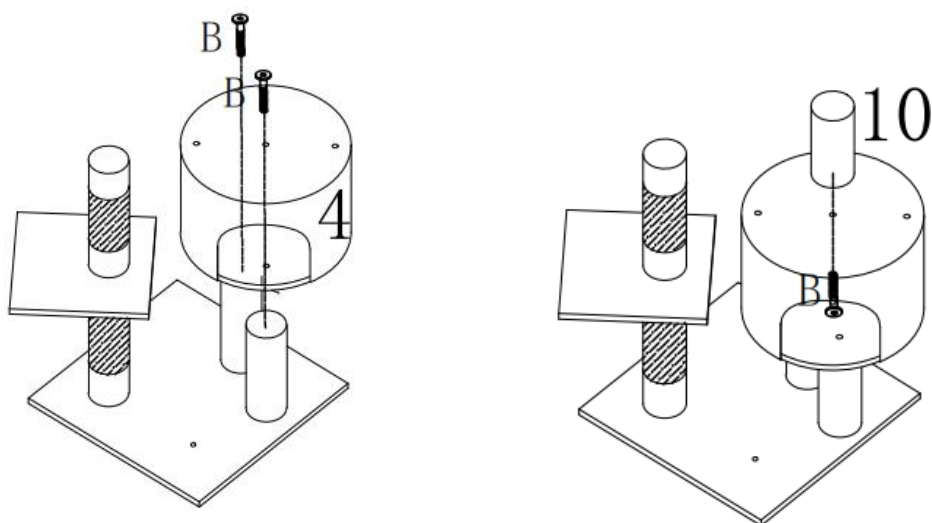

### Step 5.

Insert screw A into pole No.12, then attach board No.6 onto screw A. Screw pole No.13 onto the top of board No.6 with screw A. Secure with screws B through board No.6, into pole No.10. Refer to below image:

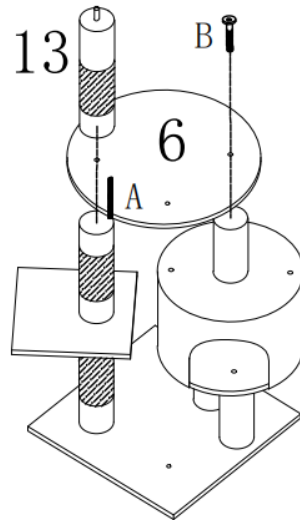

### Step 6.

Screw top board No.7 onto pole No.13. Screw rope No.15 under board No.6. Screw spring No.8 into board No.1.

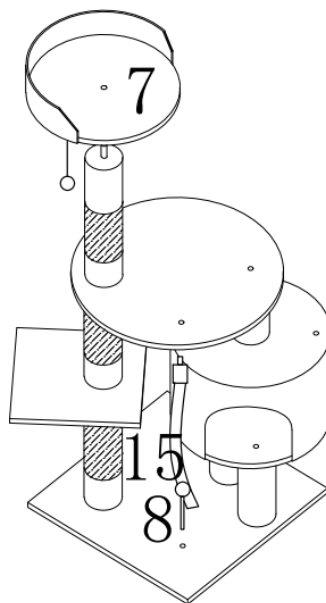

### WARNING:

**For your pet's safety, inspect regularly and remove if damaged.**

**Always supervise your pet during play.**