

INSTRUCTION MANUAL

BICYCLE ASSEMBLY & MAINTENANCE

**12" (30CM), 14" (35CM), 16" (40CM)
18" (45CM), 20" (50CM)**

CHILDREN BICYCLE

**IT IS IMPORTANT TO READ THIS MANUAL THOROUGHLY
BEFORE ASSEMBLING, RIDING, OR PERFORMING
MAINTENANCE ON THIS BICYCLE.
KEEP THIS MANUAL FOR FUTURE REFERENCE.**

Contents

| | | |
|----|----------------------------|----|
| 1. | Parts identification | 1 |
| 2. | Safety Precaution | 2 |
| 3. | Check List | 6 |
| 4. | Assembly | 7 |
| 5. | Adjustment | 15 |
| 6. | Repair and Service | 21 |
| 7. | Warranty | 28 |

NAME OF BICYCLE PARTS

Note: 1. Not all the components are illustrated as below.

2. Some parts may not be provided due to the bicycle type you purchased.

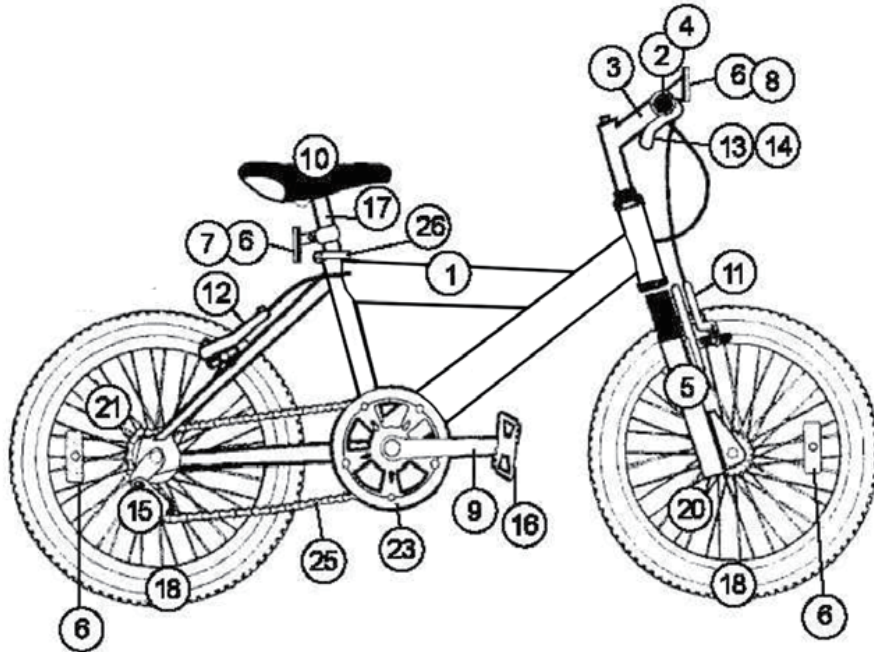



| No. | PART DESCRIPTION |
|-----|----------------------------|
| 1 | Frame |
| 2 | Grips and Plugs |
| 3 | Stem |
| 4 | Handlebar |
| 5 | Suspension or Rigid Fork |
| 6 | Reflectors |
| 7 | Rear Reflector Bracket |
| 8 | Front Reflector Bracket |
| 9 | Crank Arms |
| 10 | Seat |
| 11 | Front V-Brake |
| 12 | Rear V-Brake |
| 13 | Right Brake Lever |
| 14 | Left Brake Lever |
| 15 | Rear Derailleur |
| 16 | Pedals |
| 17 | Seat Post |
| 18 | Front / Rear Tire |
| 19 | Front / Rear Inner Tube |
| 20 | Front Wheel |
| 21 | Rear Wheel |
| 22 | Shifter |
| 23 | Front Sprocket and Guard |
| 24 | Rear Sprockets |
| 25 | Chain |
| 26 | QR Seat Post Clamp |
| 27 | Kickstand / Training Wheel |

SAFETY PRECAUTION

Owner's Safety Information and Responsibility

To reduce the risk of serious personal injury, you should read the instruction in this manual carefully.

There are  **WARNINGS** throughout this manual, please follow all **WARNING** instructions.

 **WARNING: This bicycle is made to be ridden by one rider at a time for general transportation and recreational use. It is not made to withstand the abuse associated with stunting and jumping.**

1. The bicycle has been supplied partial assembled. It is owner's responsibility to read and follow all the assembly and adjustment instructions exactly as written in this manual. Or you may ask a bicycle mechanic to assemble this item.
2. Know how to operate all standard and accessory equipment on the bicycle.
3. Your bicycle conforms to relevant Australian Standards. Other local bicycle regulations may apply. Check with your retailer.



WARNING: Read through the following Rules of the Road to reduce the injury to the rider or to others.

Rules of the road

1. Obey the road rules at all times, such as traffic signals, signs and giving way to pedestrians.
2. Always wear a bicycle helmet that meets the local safety standards.
3. Always ride in the same direction as the traffic. Never ride against the traffic.
4. Avoid the following hazards: Drain grates, soft road edges, gravel or sand, pot holes or ruts, wet leaves, or uneven paving.
5. When crossing railroad tracks do so carefully at a 90 degree angle to prevent loss of control.
6. Do not carry packages or object that obstruct your vision or control.
7. Do not carry passengers.
8. Do not ride with both hands off the handlebars.
9. Use hand signals. Indicate intended actions, such as turning or stopping, by using appropriate hand signals.
10. If there is front brake, apply the rear brake first, and then apply the front brake. The front brake is strong and if not used correctly you may lose control and fall.
11. Do not use items that may impede your hearing. E.g. head phones.
12. Ride predictably and in a straight line.

Wet Weather

1. Use extra caution in wet weather.
2. Avoid sudden braking
3. Apply brakes sooner in wet conditions, as stopping distance increases in wet weather.
4. Slow overall riding pace and approach corners more carefully.

Night Riding

Avoid riding at night if possible, if you choose to ride at night:

1. Purchase, install, and use a front and rear bicycle light.
2. Make sure the reflectors of your bicycle are correctly positioned.
3. Use a flashing rear light to improve visibility.
4. Wear light-colored reflective clothing, such as a reflective vest and reflective bands for your arms and legs.



Right Way



Wrong Way

 **WARNING: Always wear a correctly fitted and fastened helmet when riding your bicycle.**

To determine the correct size of the bicycle for the rider.

The correct frame size is the largest frame that the rider can automatically straddle keeping both feet on the ground and allowing 25mm(1 inch) clearance(1) between the rider's crotch and the top of the frame tube(2). The minimum leg-length(3) for the rider is the highest part of the top of the frame tube plus 1 inch. Note Girls can use boys' bicycle to determine their correct frame size.

Rider must be able to straddle bicycle with at least 1 inch(2.54cm) clearance above the horizontal bar when standing.

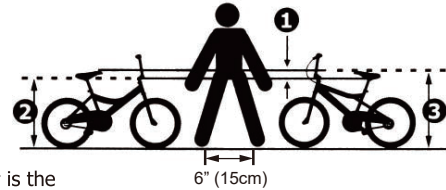

Tools required (Not included in the package)



Phillips head screwdriver;
adjustable wrench or an 8mm, 10mm, 13mm, 14mm
15mm open and box end wrenches; Allen Keys;
A plier with cable cutting ability; Air pump;

It is recommended that a torque wrench is used when assembling the bike.

Keep a Record of Your Bicycle

Each bicycle has a Serial Number stamped into the frame. Write down this number to keep it for future reference.

Take a colour photograph of your bicycle, write the Serial number on the back of the photograph and keep it in a safe place.

If you keep a record of the details of your bicycle it will greatly increase the possibility of getting it back should it be lost or stolen.

Remember the advice about LOCKING YOUR BICYCLE. A good quality lock is cheap insurance.

Safety Check List

Before riding, it is important to carry out the following safety checks:

1. Nuts and bolts

Check and tighten any loose nuts, bolts and straps. If you're not sure, ask your bicycle retailer to check.

2. Brakes

Check that the brakes operate effectively.

3. Wheels and Tyres

Check by pushing down with your thumb on the top of the tyre. The tyre should depress slightly, Compare to how it feels when you know the tyres are correctly inflated. Replace damaged tyres before they puncture.

Spin each wheel and check for brake clearance and side –to –side wobble. If a wheel wobbles or hits the brake pads, take the bicycle to your bicycle retailer.

4. Handlebar and Saddle

Tighten them so they do not move and are horizontal. Check the handlebar is in good condition and the ends of the handlebar are plugged. Check the bell is fitted and working well.

Warning: Handlebar grips and tube end plugs should be replaced if damaged, as bare ends have been know to cause injury. Please check the condition of grips and bar ends before riding.

5. Chain

Ensure the chain is oiled, clean and runs smoothly.

6. Accessories

Ensure that all reflectors are properly fitted and not obscured.

Bicycle Assembly

1. Front Wheel

Assemble the front wheel to the fork as shown

(Shown with bike sitting upside-down.)

! WARNING: If you remove a brake shoe to install the front wheel, return it to the correct position as written in the "Brake and cable adjustment" Section.

-Make sure the tab of each security washer (2) is in the hole of the fork.

-Using the two axle nuts (3) with serrations, attach the front wheel.

! WARNING: Do not use the nuts without serrations to attach the front wheel.

put the wheel in the center of the fork and tighten both nut to the recommended torque of 25-28N.M.

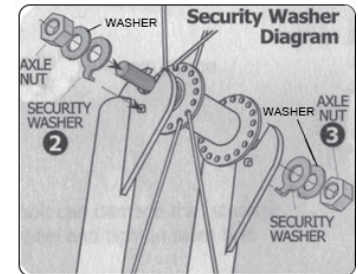
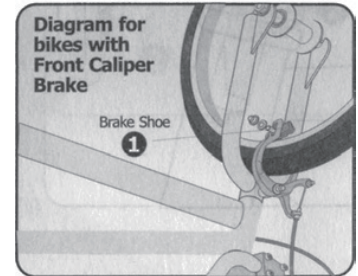
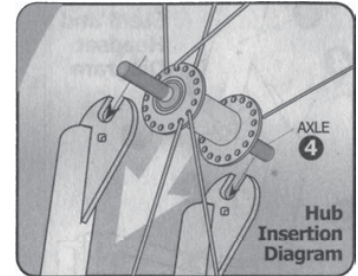

2. Training Wheel

Attach the legs to the bicycle frame:

Put the alignment insert (1), a leg (2) and an axle nut (3) on each end of the rear wheel axle (4).

Make sure the tab of the alignment insert (5), is to the rear of the axle and in the slot (6) of the frame.

Make sure both training wheels are the same distance from the ground.

Tighten the axle nuts securely.

Mud guard support may be used for some models. Attach the mud guard support to the axle after training wheel legs (2) and attach a washer and axle nut on the end of the rear wheel axle(4).

 **WARNING:** Before each ride, make sure both nuts are tight.

Also make sure both training wheels are the same distance from the ground.

As your child's ability and balance improve, you may raise or remove the training wheels.

To move the training wheels loosen the nut, slide the leg to the correct position, and retighten the nut.

To remove the training wheels, remove the nut, leg, and alignment insert.

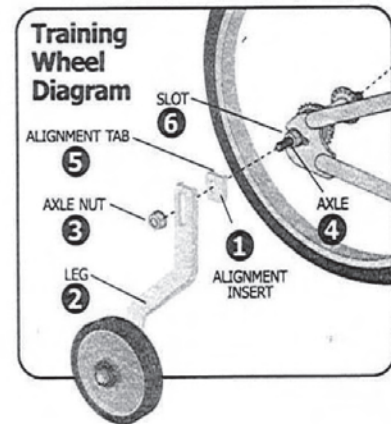

3. Install Pedals

All pedals have L or R stamped on the threaded spindle of each pedal.

1. Thread the pedal marked R clockwise into the right or chain wheel side of the crank arm.
2. Thread the pedal marked L counter-clockwise into the left side of the crank arm.

NOTE: Hand thread pedals into position without use of a wrench to ensure threads are not crossed threads. Damage to crank arm will result from crossed threads. When tightening with a wrench, make sure each spindle is firmly seated against the crank arm. If Jaws of wrench are too thick, they may prevent proper tightening of pedal spindle against crank arm.

4. Install Saddle

1. Insert the seat post into bicycle frame tube with small swaged end up.

Note: Seat post must be inserted at least to minimum insertion mark stamped on the lower part of the post.

2. Tighten the seat post clamp nut or quick release securely. Recommended torque is 12-17N.M.
3. Loosen saddle clamp nuts or quick release so saddle clamp will fit down fully onto top swaged end of seat post.
4. Tighten seat post bolt. Recommended torque is 12-17N.M.

Note: If there is rear reflector, please install the rear reflector to the seat post before insert to the seat tube.

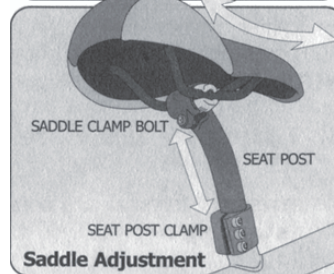
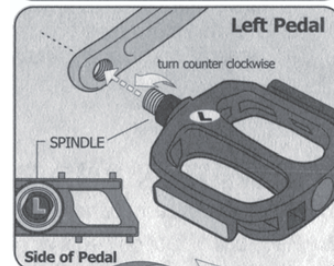
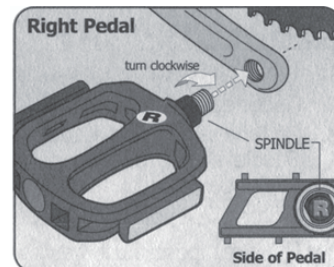

Handlebar and Stem

1. Assemble the stem to the fork:

If necessary, assemble the stem bolt (4), washer (5), and wedge nut (2) to the stem (1).

Turn the stem bolt only four revolutions into the wedge nut (2).

Point the stem toward the front of the bicycle and put it into the locknut (6).

Put the stem at a comfortable height for the rider and tighten the bolt firmly.

Normal used stem types as shown below.

⚠ WARNING: To prevent steering system damage and possible loss of control, the MIN-IN (MINIMUM INSERTION) mark (3) on the stem must be inside the locknut.

Make sure you can not see the MIN-IN mark on the stem above the locknut.

Tighten the stem bolt just enough that the stem will not fall into the locknut.

⚠ WARNING: Do not over tighten the stem bolt. Over tightening the stem bolt can damage the steering and cause loss of control.

Make sure the stem is aligned with the front wheel and tighten stem bolt.

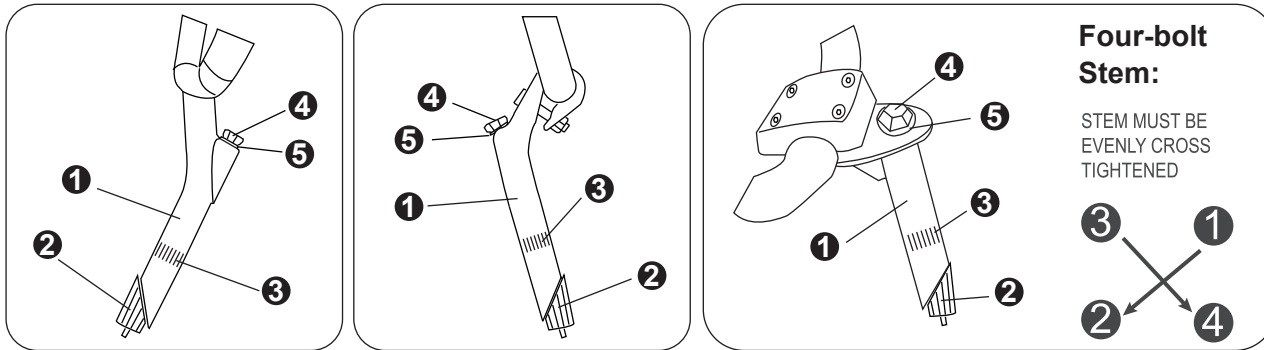

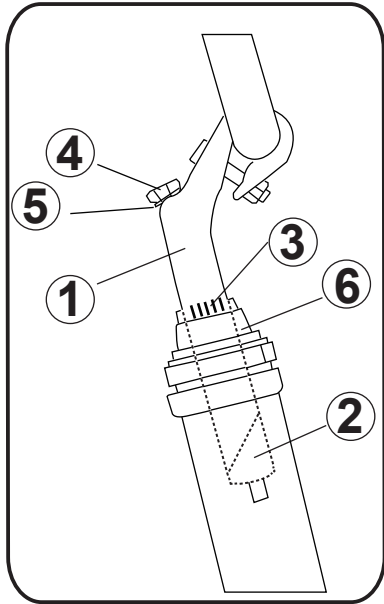

Handlebar and Stem (continued)

2. Test the tightness of the stem:

Straddle the front wheel and hold it between your legs.

Try to turn the front wheel by turning the handlebar. If the handlebar and the stem turn without turning the front wheel, realign the stem with the front wheel.

Tighten the bolt tighter than you did before (about half a revolution only at a time).

Do this test again, until the handlebar and the stem do not turn without turning the wheel.

3. Test the tightness of the handlebar

Hold the bicycle stationary

and try to move the ends of the handlebar forward or backward.

If the handlebar moves, loosen bolts of handlebar clamps.

Put the handlebar in the correct position.

Tighten the bolts of the handlebar clamp tighter than before.

If the handlebar clamp has more than one bolt, tighten the bolts equally.

Do this test again, until the handlebar does not move in the handlebar clamp.

Assemble the Accessories

1. Assemble the crash pad (If Applicable)

Assemble the pads in the correct location as shown.
Attach with the sewn-in Velcro fasteners.

2. Bell

The bell is attach to the handlebar. Adjust the bell ring into a comfortable place that is easy to use when riding.

3. Push bar (If Applicable)

Slide the end of the push bar onto the seat post, tighten securely with the collar and nut provided.

4. Quick release adjustment (If Applicable)

Loosen the quick release handle and insert the seat post into the seat tube.

Tighten the quick release with suitable strength. Make the handle of the quick release vertical with the seat post. Pull the handle of the quick release to the front of the seat post.

5. Front Board (If Applicable)

Attach the Front Board (Number Plate) to the handlebar with 2 pcs of Zip tie provided.

Attach the front board firmly and cut the rest of zip tie.

6. Front Reflector

Put the reflector bracket onto the handlebar stem. Make sure the clear reflector is vertical, pointing toward the front of the bicycle. Tighten the screw with Phillip screwdriver.

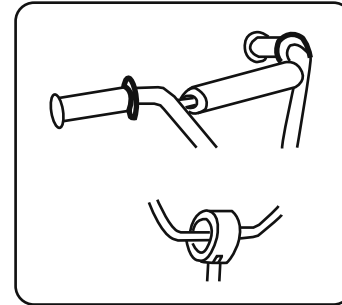

Assemble the Accessories (continued)

7. Rear Reflector

Assemble the red reflector onto the seat post. Make sure the red reflector is vertical, pointing toward the rear of the bicycle.

Tighten the screw with Phillip screwdriver.

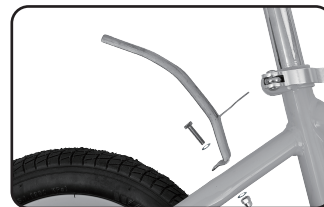

8. Doll Carrier (if applicable)

Loose the bolt and nut on frame and attach the steel bracket firmly if it is not pre-assembled in factory.

Attach the Plastic Doll Carrier to the Steel Bracket with 2 pcs of bolts provided by cross head screwdriver.



9. Front Mudguard (if applicable)

Remove the self locking nut and flat washer from the brake spindle, attach the front mudguard support bracket onto the brake spindle.

Refit the flat washer and self locking nut and tighten securely.

⚠ WARNING: Check the brake assembly to ensure it operates correctly after re-assembly.

10. Other Accessories

Assemble other accessories that may be provided, such as basket, toys, pushbar etc.

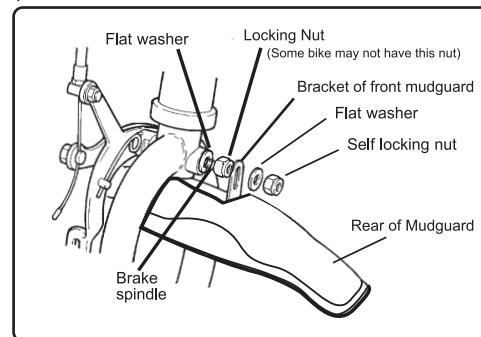

Brake installation

(For Bicycles equipped with a Front Brake)

1. Attach the upper cable to the brake lever. Ensure that the adjusting barrel is fully tightened in the brake lever.
2. Pull the link wire on the rear brake assembly until the brake shoes are touching the rim wall and tighten the brake bolt.
3. Ensure that the brake shoes are positioned evenly with the side surface of the rim.

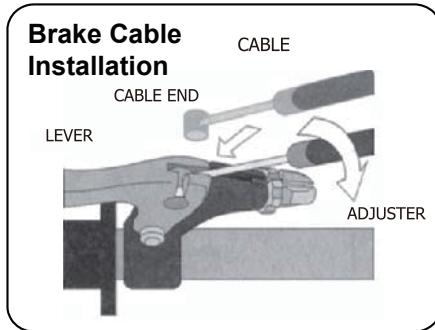

Attaching the Front Brake Cable

1. Open the brake lever and place the barrel end of the cable into the lever.
2. Feed brake cable through cable adjuster and through anchor bolt. Secure anchor bolt firmly.
3. Fasten brake caliper to fork by sliding brake mount bolt through center hole in fork. Secure brake mount bolt firmly.
4. Refer to the next section for Braking System Adjustment.

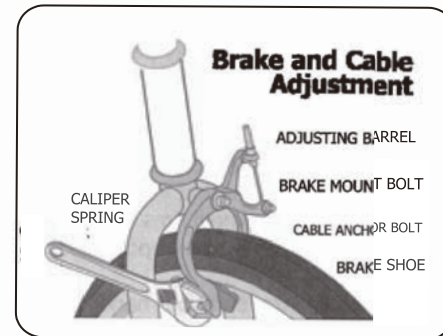

Brake System Adjustments

⚠ WARNING: You must adjust the front and rear brakes as written before you ride the bicycle.

1. Put the brake shoes in the correct position:

Loosen the nut (1) of each brake shoe. Adjust each brake shoe so it is flat against the rim and aligned with the curve of the rim. Make sure each brake shoe does not rub the tyre. If the surface of the brake shoes has arrows, make sure the arrows point toward the rear of the bicycle. Hold each brake shoe in position and tighten the nut.

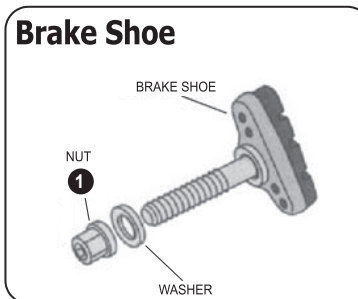

2. Test the tightness of each brake shoe:

Try to move each brake shoe out of position.

If a brake shoe moves, do Step 1 again, but tighten the nut tighter than before. Do this test again, until each brake shoe does not move.

3. Stretch the cable:

Hold both brake shoes against the rim. Loosen the cable clamp. Pull the cable tight and tighten the cable clamp.

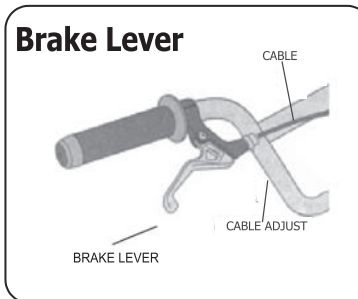

⚠ WARNING: Do not overtighten the cable clamp. Overtightening the cable clamp may cut the cable and cause injury to the rider or to others.

Squeeze each brake lever firmly 20 times. Hold both brake shoes against the rim and loosen the cable clamp. Pull the cable tight and tighten the cable clamp.

The following sections describe final brake system adjustments required before riding. Determine which style you have and follow the instructions.

1. Check tightness of caliper brake mounting nut or V-brake mounting bolts (1):

Make sure each caliper brake mounting nut or V-brake mounting bolt is tightened securely.

2. Center brake shoes on rim:

If you have a V-brake, turn the cable anchor bolt (6) on the brake arm (4) to move the arm in or out so each brake shoe is the same distance from the rim (3). If you have a caliper brake, hit downward lightly on the return spring of the brake shoe (2) that is farther away from the rim. Make sure both ends of the return spring stay hooked around the inside edge or between the studs on the back of the caliper arms. Squeeze the brake lever two times. Do this step again until both brake shoes are the same distance from the rim.

3. Put the brake shoes the correct distance from the rim (5):

Position each brake shoe 1/16 inch away from the rim.

Turn the brake lever adjusting barrel or caliper brake adjusting barrel in or out to make the adjustment. If the brake shoes cannot be positioned the correct distance from the rim, hold both brake shoes against the rim and loosen the cable anchor bolt (6).

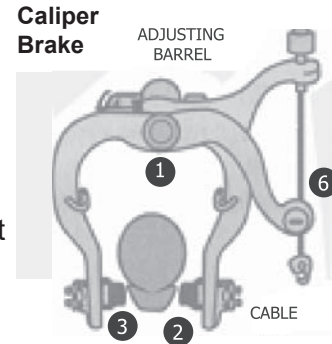

V Brake

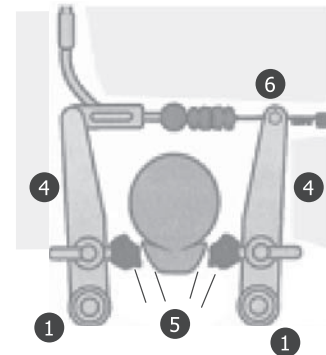

Do Step 3 until the brake shoes are the correct distance from the rim.
Turn the locknut(s) against the brake lever and the caliper brake.

 **WARNING: Do not move the brake shoes away from a wheel rim that is not true (straight). This can cause the caliper brake to be less effective and unsafe. To allow safe adjustment of the caliper brake, have a bicycle service shop to true the wheel.**

4. Check sheath position:

Make sure both ends of the sheath are fully recessed in the brake lever, sheath stops (if equipped) and brakes.

If not, install sheath in correct position and do Step 3 again. Do this test again, until the sheath is in the correct position.

5. Test the tightness of the cable clamp:

Squeeze each brake lever with firm pressure. Make sure the cable does not move in the cable clamp. If the cable moves in the cable clamp, do Step 3 and 4 again but tighten the cable clamp tighter than before.

DO this test again, until the cable does not move in the cable clamp.

6. Adjust the brake lever reach so that the distance from the grip is comfortable to the rider.

Turn the adjustment screw (if equipped) to change the distance of the brake lever from the grip. Make sure the back of each grip is no more than 3 inches from the front of each brake lever.

7. Test the travel of each brake lever.

Squeeze each brake lever with strong pressure. If the brake lever touches the grips, do Steps 1 through 7 again.

⚠ WARNING: After you do Steps 1 through 7 again, if either brake lever touches the grip or does not work well, have a bicycle service shop repair or adjust the caliper or cantilever brakes.

Reducing Caliper Brake Noise. (Caliper Brake Only)

It is common for caliper brakes to make noise or “squeak” when in use. The noise does not normally indicate a brake problem. Following the instructions below may reduce the noise:

Make sure the caliper brakes are adjusted correctly. Using a small adjustable wrench, bend each caliper arm so the front edge of each brake shoe is the first part to touch the rim.

⚠ WARNING: Bend each caliper only a small amount. If you bend the caliper arm too far, the caliper brake can be damaged and performance of the caliper brake reduced.

Brake System Operation

Operate the brakes as follows:

Squeeze the brake lever on the handlebar. The brake lever pulls on a cable that is attached to the brake. The brake squeezes the rim between two brake shoes.

Operate the brakes by squeezing both brake levers slowly and continuously until you feel the braking action. Make a habit of always using both brakes to stop the bicycle. You will stop in the shortest distance by using both brakes.

 **WARNING:** If you do not obey the following instructions, injury to the rider or to others can occur:

Before you ride the bicycle for the first time, check and adjust the brakes as written in the “Adjustments” section. Then test the brakes and practice using them at low speed in a large and level area that is free of obstruction. If the brake block is worn, please replace the worn brake block as the instructions of “Brake System Adjustment” (Page 15)

When correctly used, the brake system is very effective. But, if you apply the front brake too strongly, you can be thrown off the bicycle. Make a habit of always using both brakes to stop the bicycle.

Always try to brake while going in a straight line. Apply brakes earlier in the following conditions: wet pavement, sand, gravel, leaves, or if you need to brake while turning. To reduce the change of skidding apply brakes intermittently.

If the rims are wet, start to brake earlier than normal because a longer distance to stop the bicycle will be necessary.

Be careful when riding downhill or at a high speed because as your speed increases, a longer distance to stop the bicycle will be necessary. Slow for curves because too much speed can force you to make a turn too wide.

Keep wax, oil, grease, etc. If the rims and the brake shoes. These lubricants will reduce brake performance and a longer distance to stop the bicycle will be necessary.

Check and adjust the brakes the first time they do not stop the bicycle quickly and smoothly, do not stop the bicycle as well as they have in the past, or if either brake lever can touch the grip.

Coaster Brake

APPLY PRESSURE TO SLOW DOWN OR STOP

The coaster brake is a sealed mechanism, which is a part of the bicycle's wheel hub. The brake is activated by reversing the rotation of the pedal cranks (see the coaster brake diagram). Start with the pedal cranks in a nearly horizontal position, with the front pedal in about the 4 o'clock position, and apply downward foot pressure on the pedal that is to the rear. The more downward pressure you apply, the more braking force, up to the point where the rear wheel stops rotating and begins to skid.

 **CAUTION:** Before riding, make sure that the brake is working properly. If it is not working properly, have the bicycle checked by your dealer before you ride it.

Adjusting your coaster brake

Coaster brake service and adjustment requires special tools and special knowledge. Do not attempt to disassemble for service your coaster brake. Take the bicycle to your dealer for coaster brake service.



APPLY PRESSURE TO SLOW DOWN OR STOP

Repair and Service

! WARNING: Inspect the bicycle frequently. Failure to inspect the bicycle and to make repairs or adjustments, as necessary can result in injury to the rider or to others. Make sure all parts are correctly assembled and adjusted as written in this manual and any Special Instructions

Rear Wheel and chain Adjustment

Maintenance: The chain must be at the correct tightness. If too tight, the bicycle will be difficult to pedal. If too loose, the chain can come off the sprockets.

! WARNING: The chain must remain on the sprockets. If the chain comes off the sprockets, the coaster brake will not operate.

When the chain (1) is at the correct tightness, you can pull it one-half inch (2) away from a straight edge (3) as shown.

Adjust the tightness of the chain as follows:

Loosen the axle nuts (4) of the rear wheel.

Loosen the clamp (5) on the brake arm(6),but do not remove the nut and screw from the clamp.

NOTE: Make sure that rear wheel is in the center of the bicycle frame.

Move the rear wheel forward or backward as necessary, until you can pull the chain on half inch away form a straightedge, Hold the wheel in the position and tighten the axle nuts to the recommended torque of 25-28N.M.

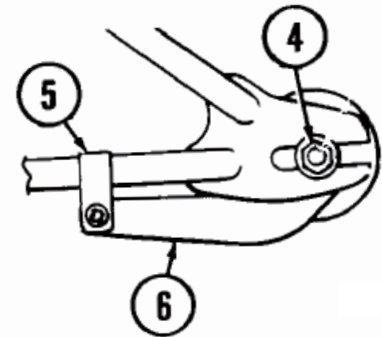
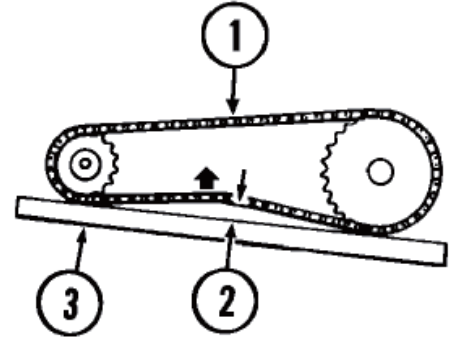

Tyre Removal

1. Let the air out of the tyre by depressing the valve core (the little pin in the centre of the valve stem opening).
2. Separate the tyre bead from the sides of the rim by pressing with your thumbs. Work your way around the tyre on both sides to be sure that the beads of the tyre are not sticking to the rim. (Figure A)
3. Stand the wheel up on the firm surface with the valve stem on the bottom and grasp the upper part of the tyre with both hands. Try to roll the tyre off the far side of the rim.
4. With the wheel standing as in Figure B, use bicycle tyre tools for spoon handles with rounded ends (at least two-preferably three) to lift the bead on one side of the tyre off the rim. Be careful not to pinch the inner tube between the tyre tools and the tyre bead or rim. Once you have got the bead off for about one fourth of the circumference of the tyre using the tools, the rest can usually be pulled off by hand.
5. With the bead on one side of the tyre completely off the rim, you can now pull the inner tube out from between the tyre and rim everywhere except in the area of the valve stem.
6. It should now be easy to pull the tyre the rest of the way off the rim. Start at the side of the wheel opposite the valve stem and simply lift the bead of the tyre up over the side of the rim and pull it off.

FIGURE A
Press with thumbs to separate tyre bead. Continue around entire rim until the bead is completely separated.



FIGURE B
Lift bead with spoons or tyre tools.



FIGURE C
replace tyre onto rim.

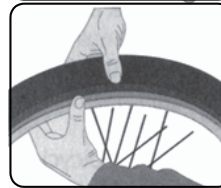

FIGURE D
Rims strip protects inner tube from spoke ends.

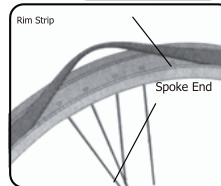

FIGURE F
Use thumb to press valve stem through hole in rim. Make certain valve stem is straight.



Frequently check the tyre inflation pressure because all tyres lose air slowly over time. For extended storage, keep the weight of the bicycle off the tyres.

Inflation: maintain tyre pressure at the level recommended on the tyre sidewalls.

Conversion from PSI to kilopascals is listed below:

40PSI=275Kpa 35PSI=241 Kpa



WARNING: Do not ride or sit on the bicycle if either inner tube is under inflated. This can damage the tyre and inner tube. Do not use unregulated air hoses to inflate the inner tubes. An unregulated hose can suddenly over inflate bicycle tyres and cause them to burst.

Use a hand or a foot pump to inflate the inner tubes. Service station meter-regulated air hoses are also acceptable. The correct inflation pressure is shown on the tyre sidewall.

Before adding air to any tyre, make sure the edges of the tyre (the bead) is the same distance from the rim, all around the rim, on both sides of the tyre. If the tyre does not appear to be seated correctly, release air from the inner tube until you can push the bead of the tyre into the rim where necessary, add air slowly and stop frequently to check the tyre sealing and the pressure, until you reach the correct inflation pressure as indicated on the tyre sidewall. Replace worn or defective tyres and inner tubes.

Recommended torque requirement:

(A) Front axle nuts: 25-28N.M (B) back axle nuts: 25-28N.M

(C) Handlebar clamp nut/bolt (4 bolt type): 9-13N.M (1 bolt type): 21-25N.M

(D) Handlebar stem expander bolt: 17-19N.M (E) seat pillar clamp nut/bolt: 17-19N.M

(F) brake cable anchor bolt: 7-11N.M (G) brake mounting bolt: 6-8N.M

(H) Seat clamp nuts: 12-17N.M (I) crank attachment systems: 24-30N.M

It is recommended that a torque wrench is used during assembly bicycle.

Inspection of Bearings

Maintenance: Frequently check the bearings of the bicycle. Have a bicycle service shop lubricate the bearings once a year or any time they do not pass the following tests.

Head Tube Bearings: The fork should turn freely and smoothly at all times. With the front wheel off the ground, you should not be able to move the fork up, down, or side-to-side in the head tube.

Crank bearings: The crank should turn freely and smoothly at all times and the front sprockets should not be loose on the crank. You should not be able to move the pedal end of the crank from side-to-side.

Wheel bearing: Lift each end of the bicycle off the ground and slowly spin the raised wheel by hand. The bearings are correctly adjusted if:

The wheel spins freely and easily. The weight of the spoke reflector when you put it toward the front or rear of the bicycle causes the wheel to spin back and forth several times. There is no side-to-side movement at the wheel rim then you push it to the side with light force.

Lubrication/Maintenance

 **WARNING: Do not over lubricate. If oil gets on the wheel rims or the brake shoes, it will reduce brake performance and a longer distance to stop the bicycle will be necessary. Injury to the rider or to others can occur.**

The chain can throw excess oil onto the wheel rim. Wipe excess oil off the chain.

Keep all oil off the surfaces of the pedals where your feet rest.

Using soap and hot water wash all oil off the wheel rims, the brake shoes, the pedals, and the tyres. Rinse with clean water and dry completely before you ride the bicycle.

Using a light machine oil (20W) and the following guidelines, lubricate the bicycle:

| What | When | How |
|----------------|------------------|--|
| Brake levers | Every six months | Put one drop of oil on the pivot point of each brake lever |
| Caliper Brakes | Every six months | Put one drop of oil on the pivot point of each caliper brake |
| Brake Cables | Every six months | Put four drops of oil into both ends of each cable. Allow the oil to soak back along the cable wire. |
| Pedals | Every six months | Put four drops of oil where each pedal axle goes into the pedal |
| Chain | Every six months | Put one drop of oil on each roller of the chain. Wipe all excess oil off the chain. |

Normal Repair Kits

Some parts of the bicycle will be easily worn down, Below is the normal repair kits for future use.

- 1.Spare inner tube ;
- 2.Patch kits
- 3.Pump
- 4.Tyre levers
- 5.Multi tools

It is recommended that significant mechanical repairs should be carried out by a skilled bicycle mechanic.



Wheels

Wheel inspection

It is most important that wheels are kept in top condition. Properly maintaining your bicycle's wheels will help braking performance and stability when riding. Beware of the following potential problems:

Dirty or greasy rims:

Caution: these can render your brakes ineffective. Do not clean them with oily or greasy material. When cleaning, use a clean rag or wash with soapy water, rinse and air dry, don't ride while they're wet.

When lubricating your bicycle, don't get oil on the rim braking surfaces.

Wheels not straight:

Lift each wheel off the ground and spin them to see if they are crooked or out of round. If wheels are straight, they will need to be adjusted. This is quite difficult and is best left to a bicycle specialist.

Broken or loose spokes:

Check that all spokes are tight and that none are missing or damaged.

Caution: such damage can result in severe instability and possibly an accident if not corrected.

Again, bicycle specialist beat handle spoke repairs.

Loose hub bearings:

Lift each wheel off the ground and try to move the wheel from side to side.

Caution: if there is movement between the axle and the hub, do not ride the bicycle. Adjustment is required.

Axle nut

Check that these are tight before each ride.

Fork replacement:

If you choose to replace the front fork, please ensure that the fork is the same size and inner tube diameter as the original fork that was sold with the bicycle.

Lubrication and Adjustment - One Piece Crank

To adjust the free play in a one piece type bottom bracket, loosen the locknut on the left side by turning in clockwise and tighten the adjusting cone counter-clockwise using a screwdriver in the slot. When correctly adjusted, re-tighten the locknut counter-clockwise.

To disassemble:

1. Remove the chain from the chainwheel
2. Remove the left pedal by turning the spindle clockwise
3. Remove the left side locknut by turning it clockwise and remove the keyed lockwasher.
4. Remove the adjusting cone by turning it clockwise with a screwdriver.
5. Remove the left ball retainer, slide the crank assembly out of the frame to the right, and remove the right ball retainer. Clean and inspect all bearing surfaces and ball retainers, and replace any damaged parts. Pack the ball bearing retainers with grease, then re-assemble in the reverse of the above procedure.

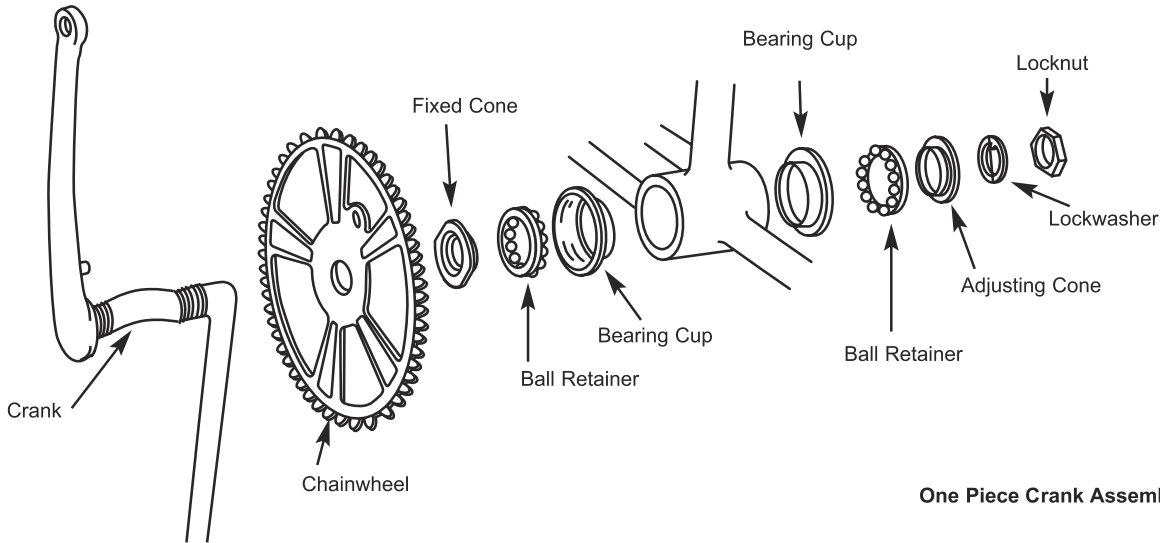

12 Month Warranty

Thank you for your purchase.

Your new product is warranted to be free from defects in materials and workmanship for the period stated above, from the date of purchase, provided that the product is used in accordance with accompanying recommendations or instructions where provided. This warranty is in addition to your rights under the Australian Consumer Law.

For New Zealand customers, this warranty is in addition to statutory rights observed under New Zealand legislation.

We will provide you with your choice of a refund, repair (where possible) or exchange (availability dependent) for this product if it becomes defective within the warranty period. The business will bear the reasonable expense of claiming the warranty.

This warranty will no longer apply where the defect is a result of alteration, accident, misuse, abuse or neglect.

Please retain your receipt as proof of purchase and contact our Customer Service Centre as listed below, for the entity you purchased this product from, for any difficulties with your product. Warranty claims and claims for expense incurred in returning this product can be addressed to the respective Customer Service Centre.

Our goods come with guarantees that cannot be excluded under the Australian Consumer Law. You are entitled to a replacement or refund for a major failure and compensation for any other reasonably foreseeable loss or damage.

You are also entitled to have the goods repaired or replaced if the goods fail to be of acceptable quality and the failure does not amount to a major failure.

| Contact for Kmart purchases | Contact for Target purchases |
|--|---|
| Kmart Australia Ltd. C/- Customer Service Centre 690 Springvale Road, Mulgrave Vic 3170 Customer Service: 1800 124 125 (Australia) or 0800 945 995 (New Zealand) or via Customer Help at kmart.com.au | Target Australia Pty Ltd C/- Customer Service Centre 2 Kendall Street, Williams Landing, Vic, 3027 Customer Service: 1300 753 567 or via Customer Help at target.com.au/help/contact-us |

WARRANTY