

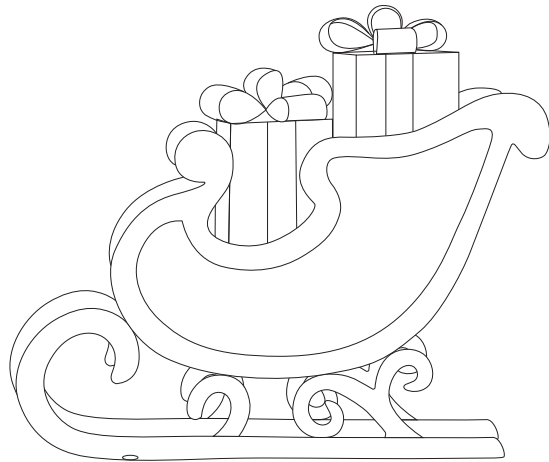

LV LED LIGHT UP SLEIGH (Model No.: LD24175S K: 43446780 / T: 70026979)

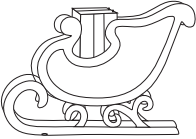

Contents:

<p>A.</p>  <p>Sleigh x 1</p>	<p>B.</p>  <p>Gftbox x 1</p>	<p>C.</p>  <p>Bow x 1</p>	<p>D.</p> <p>1</p> <p>Fixing rope x 2</p>
--	---	--	---

Assembly Diagram:

Step 1.

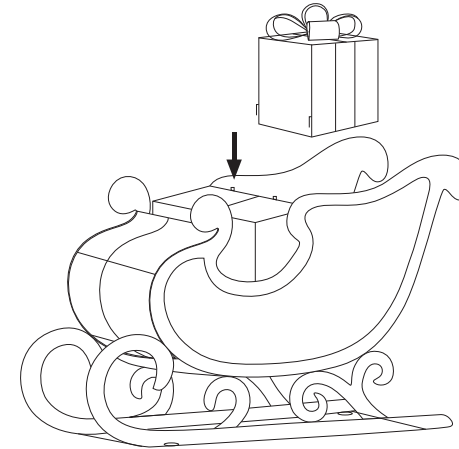

Step 2.

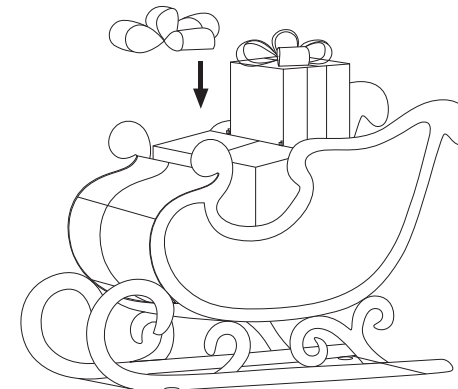

Step 3.

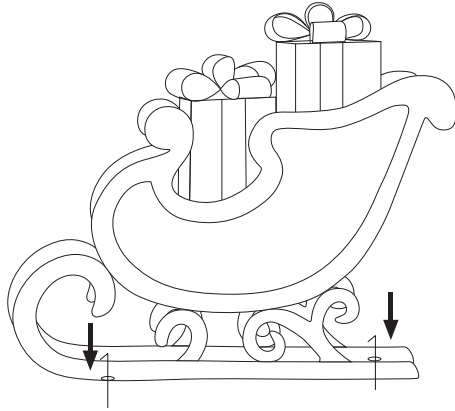

Warnings:

- The light chain is suitable for **INDOOR** and **OUTDOOR USE**.
- This product is **NOT** designed for permanent or long term use.
- The LED driver **MUST** be installed **INDOOR** away from weather.
- The LED driver is suitable for operation of LED Modules only.
- Only operate this light chain with the LED driver, **Model No. JT-DC4.5V3.6W-E4**
- Do not connect this light chain electrically to another lightchain.
- Do not operate the product while it is in the packaging.
- **DO NOT** attempt to replace the non-replaceable bulbs in this light chain.
- Never allow any part of the set to come into contact with a source of heat or flame.
- Care must be taken to avoid damage the cable or fittings.
- If any part of light set or cable is damaged, the light set **MUST** be discarded.
- This product is for use as a decoration only. Not to be used by children as a toy. Keep out of reach of children.
- Do not position this light chain where it will be exposed to extreme wet weather or submerged in water.
- Always switch off this light set or unplug an adaptor if unattended.
- **DO NOT** overload power sockets or extension leads.
- **DO NOT** pierce the cable when securing in place, bend or stand on the light chain, as this will damage the bulbs or wiring.
- Please refer to the packing or product rating label for product class, specifications and rating.

Adaptor Manual:

1. Please use the equipment according to the rated voltage and current.

Model No.	Input Rated			Output Rated	
	Voltage	Frequency	Current	Voltage	Power
JT-DC4.5V3.6W-E4	220-240VAC	50-60Hz	0.10A Max	4.5V DC	3.6W

2. Do not open the cover of the equipment.
3. For use with LED lighting equipment.
4. The input and output voltage should be checked before use to ensure correct use.
5. This is the Class II product, only for indoor use.
6. The product is not a toy, keep it where children cannot reach.
7. The lamp controlgear does not rely upon the luminaire enclosure for protection against accidental contact with live parts.
8. If applicable: an indication that the controlgear is suitable for operation with LED modules.
9. Do-not-cover classification

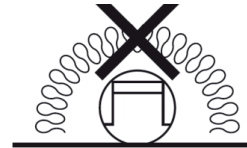

The LED driver that can be used where normally flammable materials, including building insulation are or may be present, but cannot be abutted against any material and cannot be covered in normal.

Minimum clearance distance from the top and sides of the control gear to normally flammable building element is 75mm; as shown in below picture, A=B=C=Min.75mm.

