



K: 43447701

T: 70027419

500 LED SOLAR WHITE CHRISTMAS ICICLE LIGHTS

Model No.: YF-KM-23X14

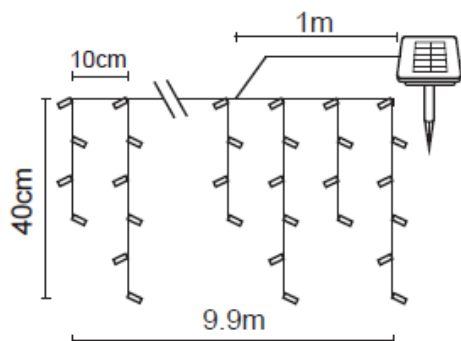

Assembly Diagram:

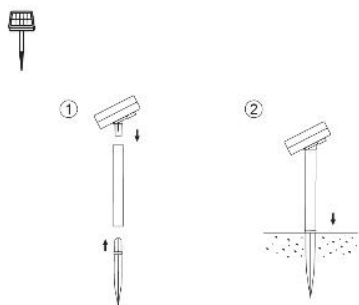

Instructions

1. Remove all packaging before use and dispose of safely.
2. Ensure there are no pipes or mains cables immediately underneath, then fix

the solar panel assembly to the ground by the anchor spike. Refer to image above.

3. Do not position or place near barbecues, heaters, or any other direct sources of heat.
4. The solar panel should be located where sunlight can fall directly on the panel. Shadows from buildings, trees, walls/hedges and similar objects should be avoided if possible as these will reduce performance.
5. Try to avoid locations where light from other sources (e.g. streetlights, floodlights etc) may affect the PIR sensor. The light stakes are designed only to illuminate in dark conditions and may not operate if light reflects on the panel.
6. The light set can be left outside in rain but should not be exposed to water jets or immersed. For optimum life, the solar panel should be stored indoors during extreme weather conditions (prolonged snow and frost).
7. Locate light set by insert the spike in the ground, choose a location where there is soft ground to enable the spike to be pushed in easily.
8. The solar light consists of a solar cell, a rechargeable battery and LED lights. All these are preassembled. During the daytime, light from the sun charges up the batteries. At night, the energy stored in the batteries is used to power the light. No other power or connections are required. The length of time the light stays on is dependent on how much sunlight has been received during the day.
9. Turn the ON/OFF switch at the bottom to "ON".
10. Place the light set at the desired locations. Ensure the cables are anchored so that they do not present a tripping hazard.

Warnings:

- The light set is designed for use OUTDOOR ONLY.
- Remove all packaging before use.
- This product is not a toy, keep out of reach of children and pets.
- This product has small parts, which may pose a choking hazard if detached.
- The battery is non-replaceable. DO NOT attempt to replace it.
- The light set is constructed with non-replaceable bulbs. DO NOT attempt to replace any of the bulbs in the light set.
- Keep away from fire and sources of heat.
- The end point of the ground stake is sharp. Please do not allow children to play with the anchor spike.
- Do not allow water to come into contact with the batteries or wiring.
- Some condensation may form inside the unit or solar panel in cold conditions. This is normal and can be ignored.