

Assembly Instructions

43461721 ISLA BEDSIDE TABLE

CARE INSTRUCTIONS:











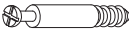

WIPE CLEAN WITH A SOFT DAMP CLOTH. NEVER USE SCOURERS, ABRASIVES OR CHEMICAL SOLVENTS. KEEP AWAY FROM MOISTURE AND DIRECT SUNLIGHT. STORE IN A DRY PLACE. FOR INDOOR USE ONLY.

WARNING:













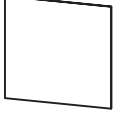

DO NOT STAND, SIT OR LEAN ON THE UNIT. DO NOT USE THIS UNIT AS A STEP LADDER. ENSURE THIS UNIT IS USED ONLY ON A FLAT SURFACE. DO NOT USE THIS UNIT UNLESS ALL BOLTS AND SCREWS ARE FIRMLY SECURED. DO NOT PLACE HOT OBJECTS SUCH AS COFFEE CUPS DIRECTLY ON THE SURFACE OF THIS FURNITURE ITEM. THIS ITEM IS FOR STORAGE PURPOSES ONLY. CONTAINS SMALL PARTS. IT IS TO BE ASSEMBLED BY AN ADULT. FAILURE TO FOLLOW THESE WARNINGS COULD RESULT IN SERIOUS INJURY.

MAXIMUM SAFE LOAD: TOP:10KG; DRAWER: 5KG.

1 Hardware List

	A		12pcs		B		12pcs		C	Ø6x30mm	8pcs
	D	M4x12mm	32pcs		E	M4x35mm	13pcs		F	M6x28mm	8pcs
	G	M6x40mm	4pcs		H		2pcs		I		4pcs
	J	M4*12mm	5pcs		K	M4mm	1pc		L		1pc
	M		1pc								

2 Parts List

							
①	1pc	②	1pc	③	1pc	④	1pc
							
⑤	1pc	⑥	2pcs	⑦	2pcs	⑧	2pcs
							
⑨	2pcs	⑩	2pcs	⑪	2pcs	⑫	2pcs
							
⑬	2pcs	⑭	2pcs	⑮	2pcs	⑯	2pcs

3

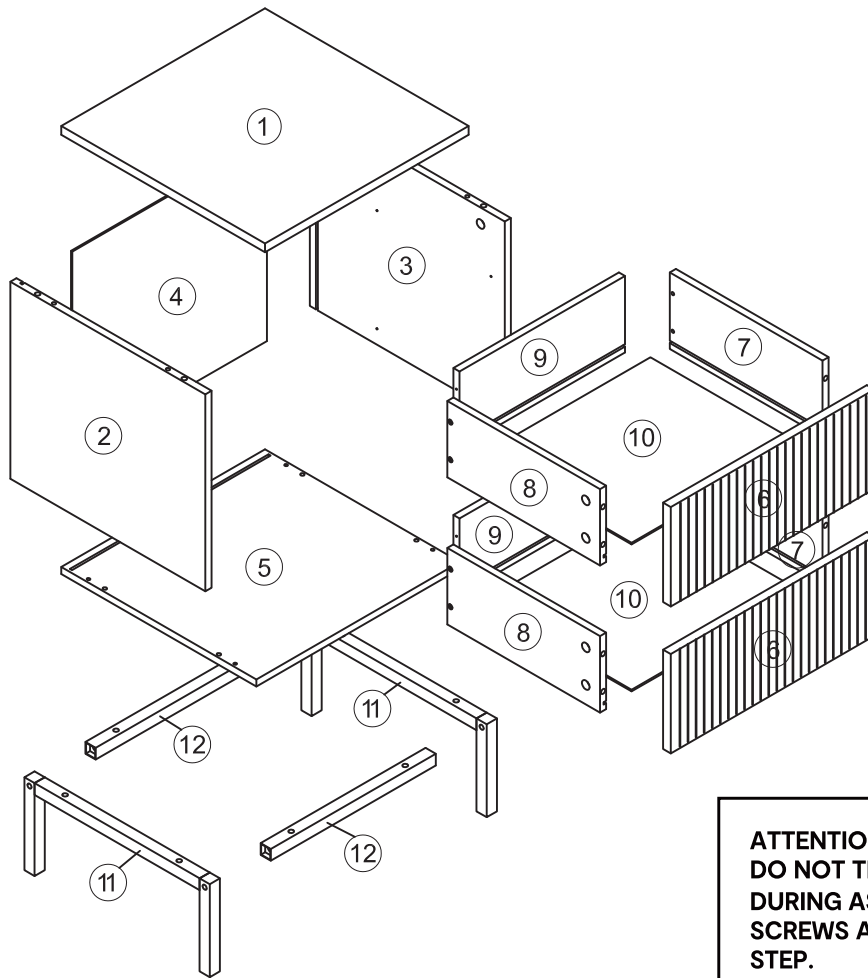

ATTENTION:
DO NOT TIGHTEN THE SCREWS FULLY DURING ASSEMBLY. FULLY TIGHTEN SCREWS AFTER THE FINAL ASSEMBLY STEP.

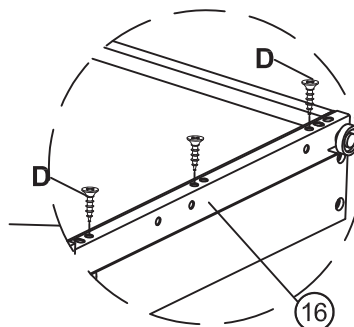
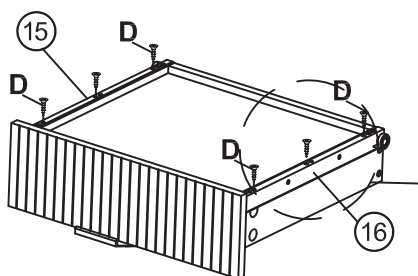
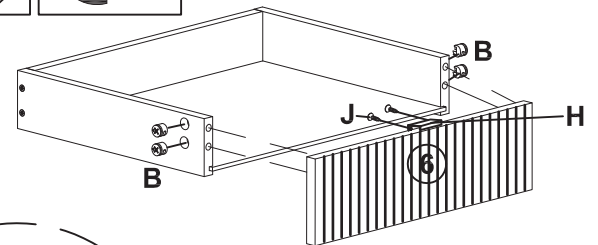
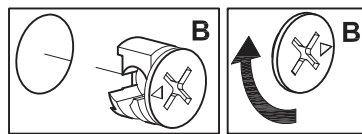
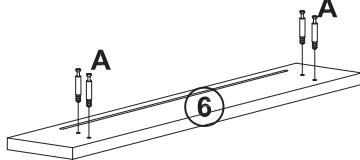
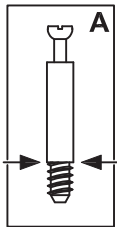
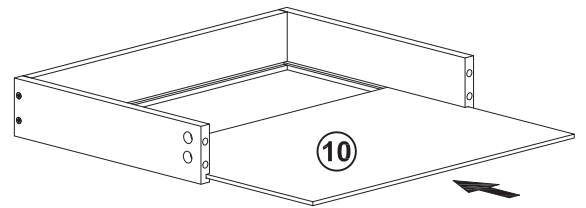
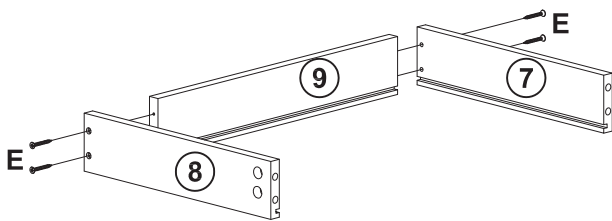

STEP 1 A - x 8 B - x 8 D - x 12 E - x 8 H - x 2 J - x 4



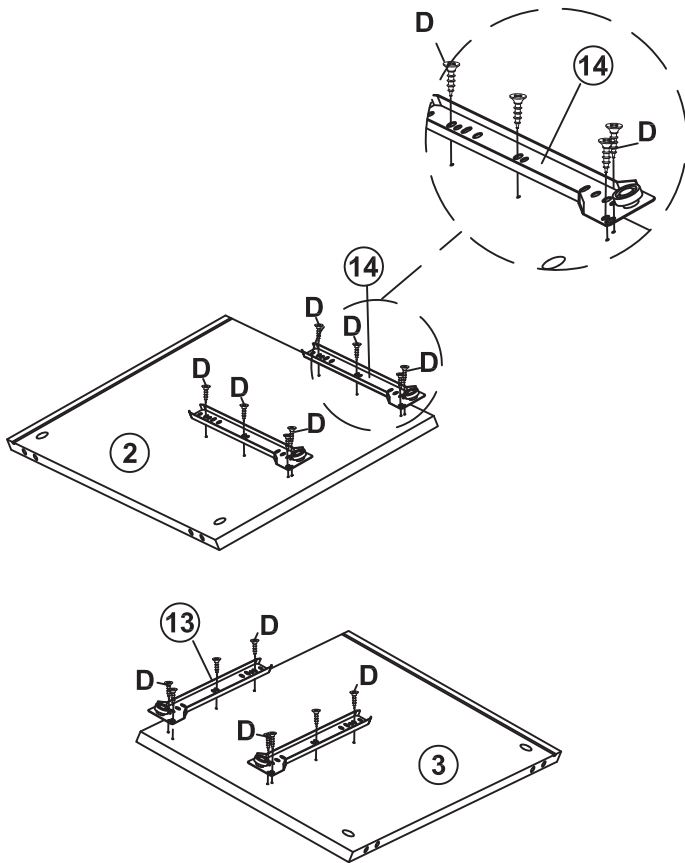

X2

STEP 2 **D -  x 16**

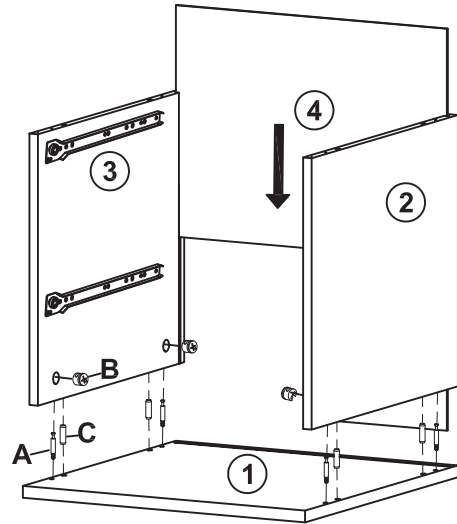

STEP 3 **A -  x 4 B -  x 4 C -  x 4**



STEP 4 **C -  x 4 E -  x 4**

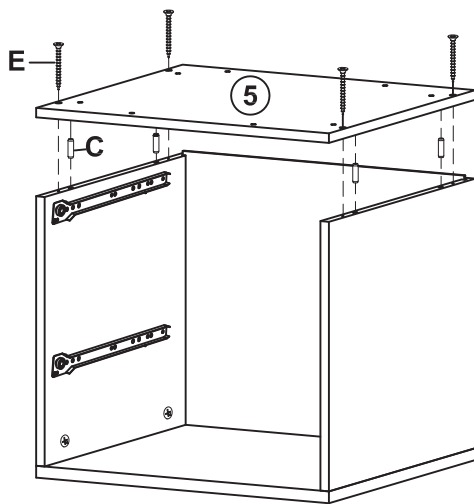

STEP 6 **F -  x 8 J -  x 1**

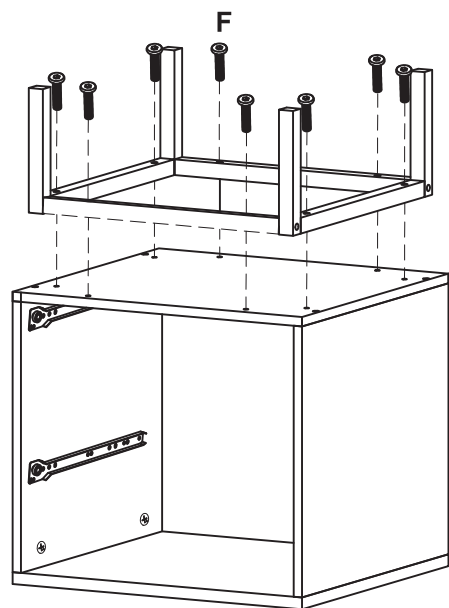

STEP 5 **G -  x 4 J -  x 1**

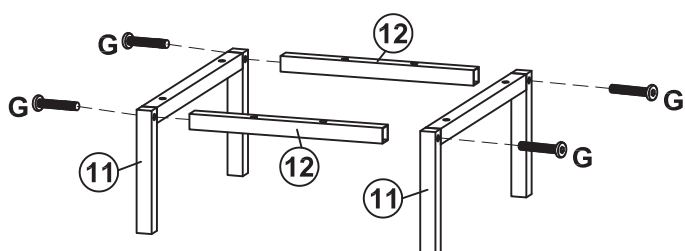

STEP 7

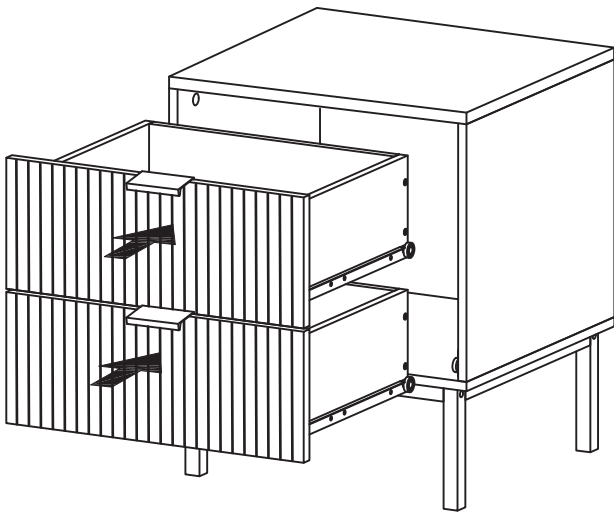

STEP 8 **D - × 4** **I - × 4**

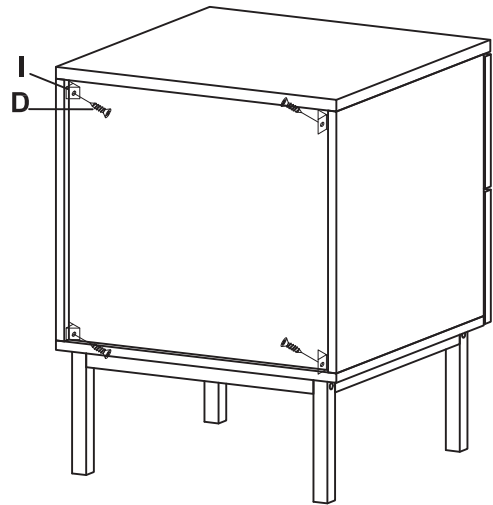

STEP 9 **E - × 1** **J - × 1** **L - × 1** **M - × 1**

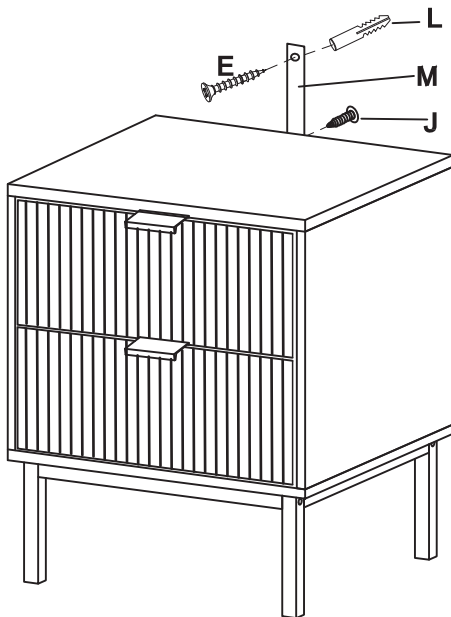

! WARNING

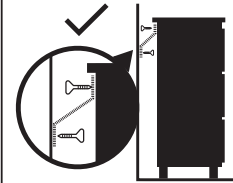

Children have died from furniture tipover.

- ALWAYS secure it with an anchor device.
- NEVER allow children to stand, climb or hang on drawers, doors, or shelves.
- NEVER open more than one drawer at a time.
- Place heavy items down low.
- Furniture type is at risk of toppling over.

NEVER put a TV on this furniture



This is a permanent label. Do not remove!

TOPPLING FURNITURE WARNING:

- It is strongly recommended that this product is permanently fixed to the wall.
- Please seek professional advice if you are in doubt of what fixing device to use.
- Regularly check that anchors are securely maintained.
- Use safety drawer locks to prevent children climbing.
- Stability of tall items may be affected by thick pile carpet or uneven floors .
- Do not place unanchored televisions on furniture .

CAUTION: for your safety when attaching the anchor fixings, please note the following:

- Check any electrical wires or plumbing inside the wall before drilling any holes (if you are unsure please seek professional advice from a qualified tradesperson).



WARNING: PLEASE SECURE YOUR FURNITURE WITH THE SUPPLIED WALL FIXING. SCAN THE CODE FOR MORE INFORMATION.

