

Assembly Instructions









K :43465958 | T:70171730 8 DRAWER CHEST





ATTENTION:

DO NOT TIGHTEN THE SCREWS UNTIL THE PRODUCT IS FULLY ASSEMBLED.
FOR INDOOR USE ONLY.

MAXIMUM LOADING WEIGHT: 10 KG FOR TOP PANEL, 3KG FOR EACH DRAWER.

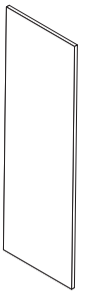
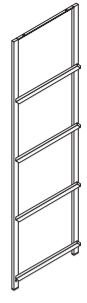
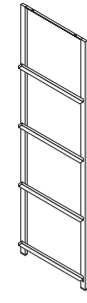
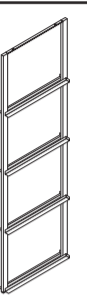
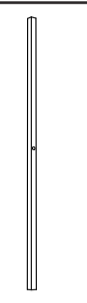
Hardware list

	(A)	4PCS		(F)	2PCS
	(B)	7 PCS		(G)	2PCS
	(C)	10PCS		(H)	2PCS
	(D)	1PC		(I)	5PCS
	(E)	2PCS			

	(1)	1PC		(2)	1PC		(3)	1 PC
	(4)	1PC		(5)	2PCS		(6)	8PCS
							(7)	8PCS
							(8)	2PCS

STEP 1

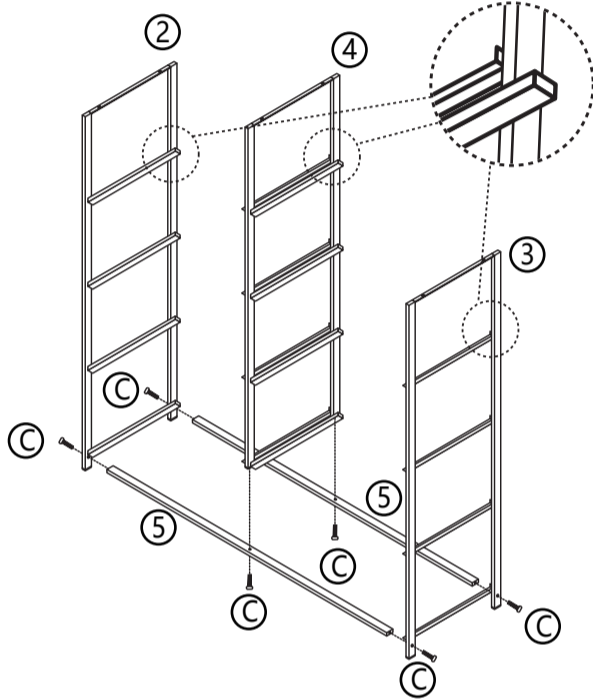

 (C) 6pcs

STEP 2

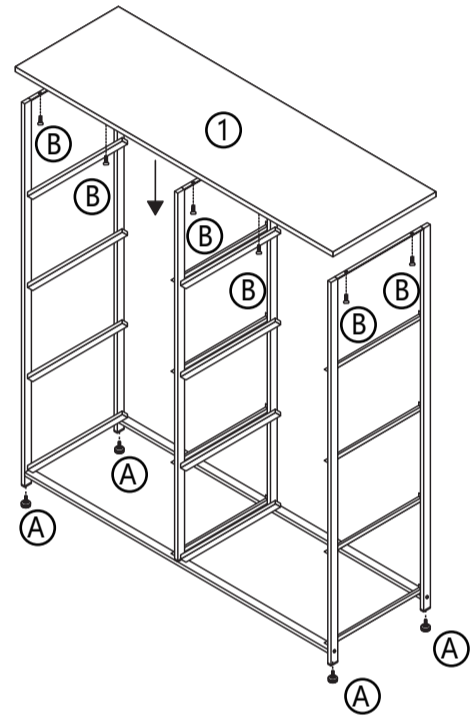

 (A) 4pcs  (B) 6pcs

STEP 3

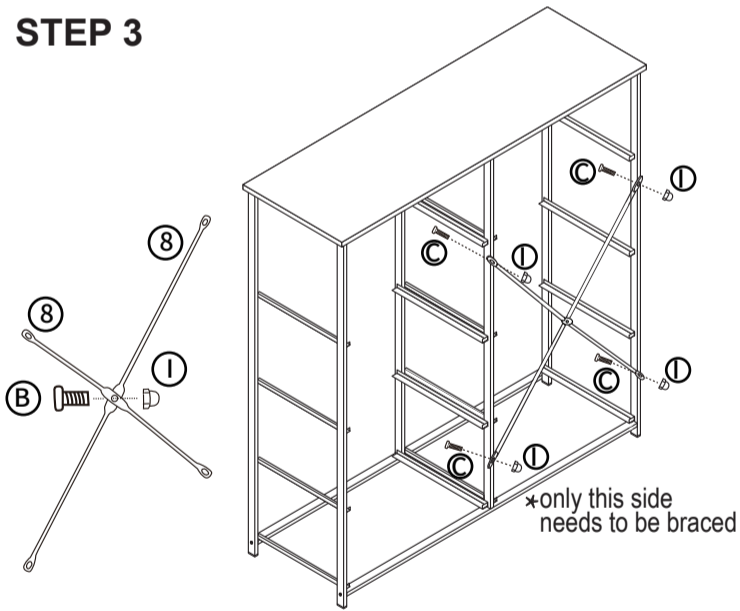

 (B) 1pc  (C) 4pcs  (I) 5pcs

STEP 4

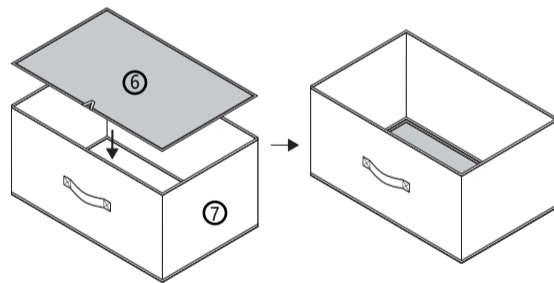

X8

STEP 5

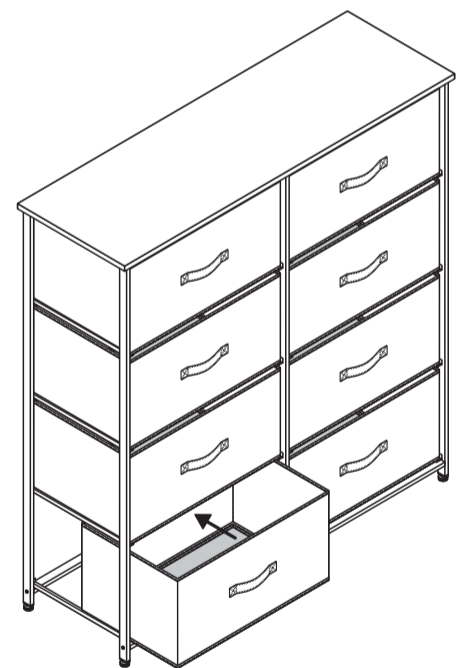

STEP 6

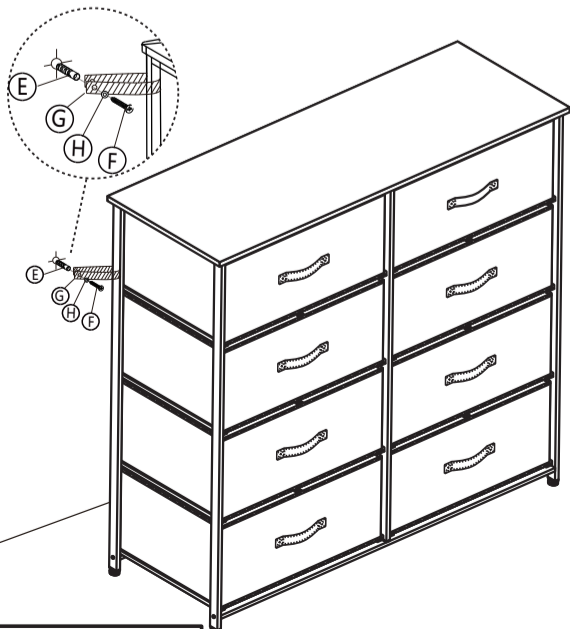

 (E) 2pcs  (F) 2pcs  (G) 2pcs  (H) 2pcs

WARNING

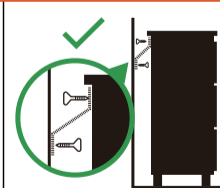

Children have died from furniture tipover.

- ALWAYS secure it with an anchor device.
- NEVER allow children to stand, climb or hang on drawers, doors, or shelves.
- NEVER open more than one drawer at a time.
- Place heavy items down low.

NEVER put a TV on this furniture 

This furniture is at high risk of toppling over

Ask staff for more information or visit <https://www.productsafety.gov.au>

Instruction manual should also state:

- It is strongly recommended that this product is permanently fixed to the wall.
- Please seek professional advice if you are in doubt of what fixing device to use.
- Regularly check that anchors are securely maintained.
- Use safety drawer locks to prevent children climbing.
- Stability of tall items may be affected by thick pile carpet or uneven floors.
- Do not place unanchored televisions on furniture.

Caution: for your safety when attaching the anchor fixings, please note the following:

Check any electrical wires or plumbing inside the wall before drilling any holes (if you are unsure please seek professional advice from a qualified tradesperson)



WARNING: PLEASE SECURE YOUR FURNITURE WITH THE SUPPLIED WALL FIXING. SCAN THE CODE FOR MORE INFORMATION.

