

# Assembly Instructions

## 43471812 CUSTOM STORAGE SINGLE SYSTEM

**CARE INSTRUCTIONS:** WIPE CLEAN WITH A DAMP OR DRY CLOTH. DO NOT USE ABRASIVE MATERIALS AND SOLVENTS. KEEP AWAY FROM WATER AND DIRECT SUNLIGHT. STORE IN A DRY PLACE. FOR INDOOR AND DOMESTIC USE ONLY.







**WARNING:** WHEN THIS PRODUCT IS INSTALLED IN A PLASTER WALL, PLEASE MAKE SURE THAT THE WALL SURFACE IS STABLE, DRY AND INTACT. IF UNSURE PLEASE SEEK PROFESSIONAL ASSISTANCE IN INSTALLING THIS PRODUCT, IN PARTICULAR IF NOT ABLE TO LOCATE A STUD WALL. PLASTER WALLS ARE QUITE DELICATE. BEFORE STARTING TO INSTALL, PLEASE READ THESE INSTRUCTIONS CAREFULLY TO MAKE SURE YOU USE THE RIGHT TOOLS AND FOLLOW THE CORRECT STEPS FOR INSTALLATION. PLEASE CHOOSE THE SUITABLE HARDWARE ACCORDING TO YOUR WALL TYPE. USING A DRILL BIT WITH THE WRONG DIAMETER WILL CAUSE THE HARDWARE INSTALLATION TO FAIL AND DAMAGE THE WALL. A STUD WALL MUST BE LOCATED WITHIN THE SPACE HANGING TO ENSURE MAXIMUM STABILITY AND STRENGTH. THIS PRODUCT REQUIRES AT LEAST TWO PEOPLE FOR INSTALLATION. OPERATING ALONE MAY LEAD TO IMPROPER INSTALLATION OR SAFETY ACCIDENTS. IMPROPER INSTALLATION REQUIRES A SPACE BETWEEN.

**MAXIMUM SAFE LOAD: 20KG FOR EACH SHELF WITH HANGING RAIL.**

**PLEASE SEEK PROFESSIONAL ADVICE IF IN DOUBT.**

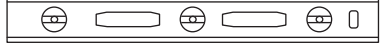
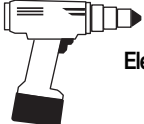
**INSTRUCTIONAL VIDEO:** [https://youtu.be/ERVGN3vR\\_sQ](https://youtu.be/ERVGN3vR_sQ)







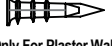
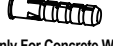

### Required Assembly Tools

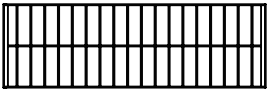
 Tape Measure	 Ladder	 Spirit Level	 Electric Drill	 Wall Stud Finder
 Pencil		 Phillips Head Screwdriver	 Hammer	

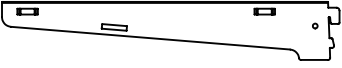
### Hardware List

 A	M4x50mm	21pcs	 B	M14x40mm	21pcs	 C	M7.5x38mm	21pcs
			Only For Plaster Wall			Only For Concrete Wall		

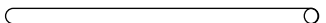
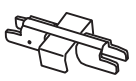
### Parts List

	wire shelf		wall strip		right bracket		left bracket
①	2PCS	②	4PCS	③	2PCS	④	2PCS
	hang track		right hanger hook		left hanger hook		hanger rail
⑤	1PC	⑥	2PCS	⑦	2PCS	⑧	2PCS
	connector		Beam sticker				
⑨	2PCS	⑩	1PC				

**INSTRUCTIONAL VIDEO AVAILABLE ONLINE**

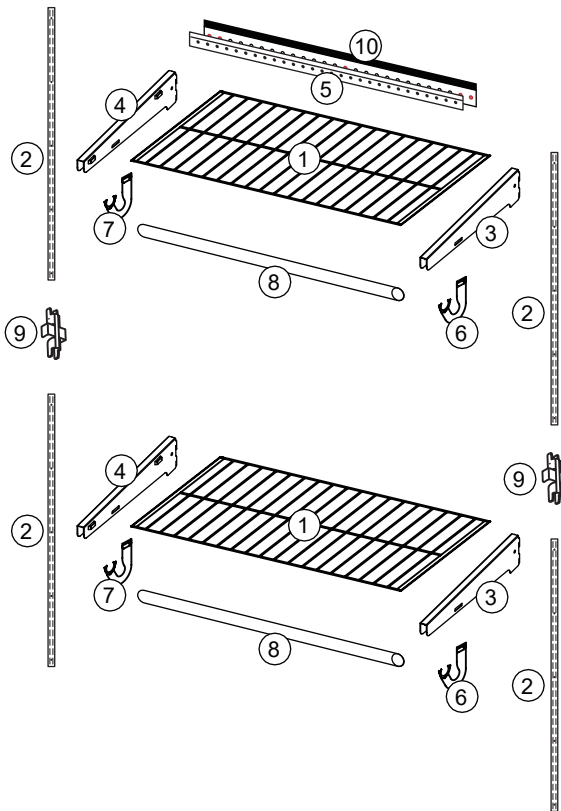

Do not tighten the screws fully during assembly.  
Fully tighten screws after the final assembly steps

## Tips Before you Start

### APPLICABLE HARDWARE FOR DIFFERENT WALL TYPES AND THEIR METHODS OF USE.

Tape Measure	Ladder	Spirit Level	Phillips Head Screwdriver	Phillips Head 3mm Drill Bit	Wall Stud Finder
Pencil		Phillips Head Screwdriver			

#### PLASTER WALL: MINIMUM THICKNESS > 10MM

WHEN INSTALLING THE PRODUCT ON A PLASTER WALL WITHOUT STUDS, PLEASE USE A SCREWDRIVER WITH TYPE A SCREWS AND TYPE B ANCHORS FOR INSTALLATION.  
NOTE: WHEN INSTALLING ON STUDS, PLEASE DIRECTLY USE ELECTRIC DRILL AND TYPE A SCREWS.

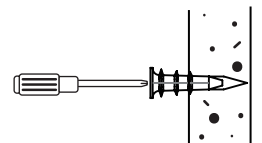

Tape Measure	Ladder	Spirit Level	Phillips Head Screwdriver	Phillips Head 3mm Drill Bit
Pencil		Phillips Head Screwdriver		

#### WOOD WALL

USE A 3MM DIAMETER DRILL BIT TO MAKE A HOLE AND ENSURE THAT THE DEPTH OF THE INSTALLATION HOLE IS GREATER THAN 5CM. PLEASE USE TYPE A SCREWS FOR INSTALLATION.

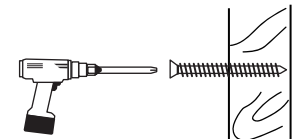

Tape Measure	Ladder	Spirit Level	Phillips Head Screwdriver	Hammer	6mm Drill Bit
Pencil		Phillips Head Screwdriver			

#### CONCRETE WALL: MASONRY WALLS, CONCRETE WALLS, BRICK WALLS, ETC.

USE A 6MM DIAMETER DRILL BIT TO MAKE A HOLE AND ENSURE THAT THE DEPTH OF THE INSTALLATION HOLE IS GREATER THAN 5CM. PLEASE USE TYPE A SCREWS AND TYPE C ANCHORS FOR INSTALLATION. INSTALL TYPE C ANCHOR AND SECURE THE PLASTIC PIECE IN THE HOLE USING A HAMMER.

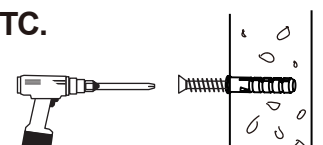

**This setup shows steps for a plaster wall. If your wall is different, use the right tools shown in the TIPS for your wall type. Please seek professional advice if in doubt.**

**STEP 1** establish the suitable height and Mark with pencil,

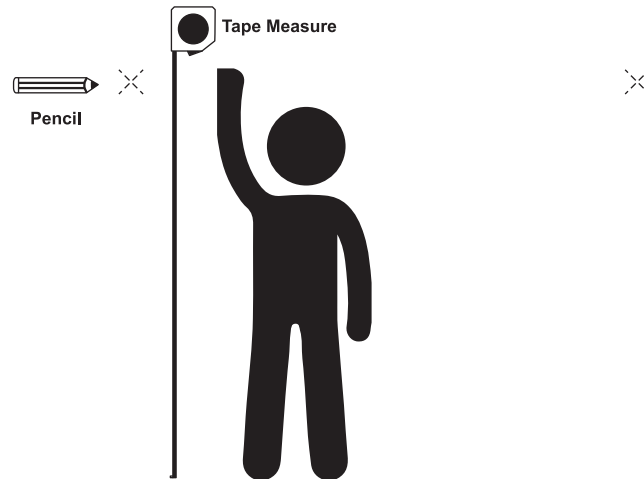

If using the full system, please ensure that the hang track is at least 200cm above the ground.

**STEP 2** Draw a horizontal line based on the marked points.

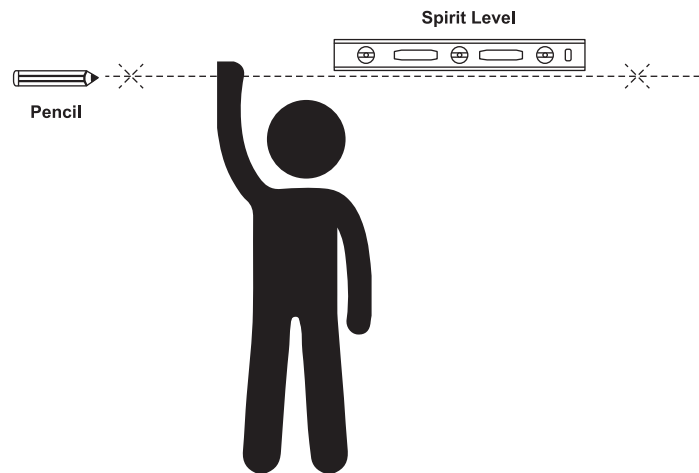

**STEP 3** Use the wall stud finder to find the stud and Mark the location of the studs.

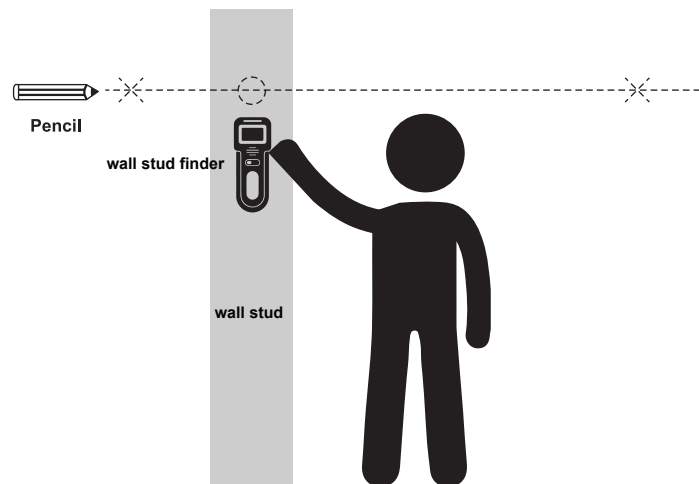

It is highly recommended that the wall strip is mounted on stud, please try and locate the stud and ensure the screws are used at this point as well as the centre of the hang track.

**STEP 4** Use a level to ensure that item hang track Beam sticker is horizontal.

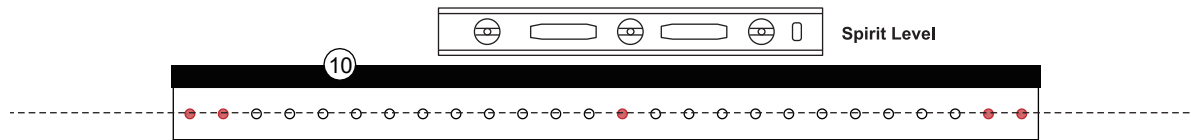

Secure the hang track Beam sticker according to the horizontal line with the condition that at least one wall strip can be attached to a stud. Also ensure that the mounting holes of the wall strip align with the location of the stud.

Noted: If wall strip cannot install on the stud, please make sure at least one type A screw be used on the hang track with the stud.

**STEP 5** Drill holes with B according to the markings on the Sticker, then remove the sticker.

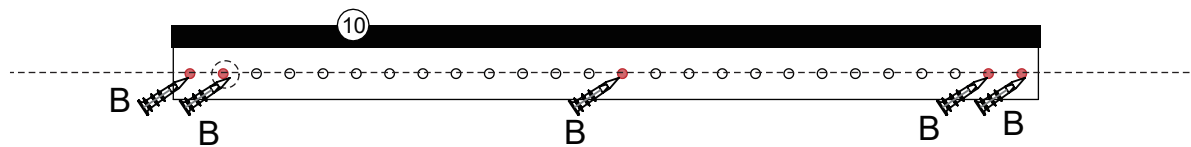

note: when install with stud, please use the type A screw .

**STEP 6**

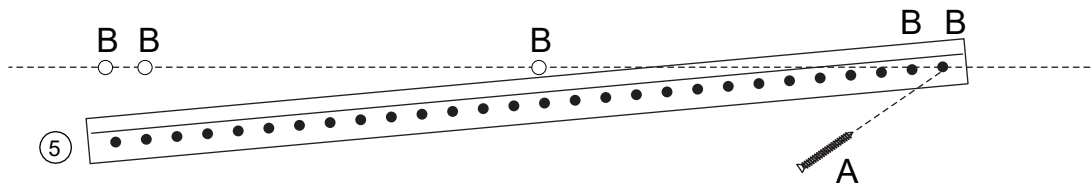

Secure one end of the hang track with a screw.

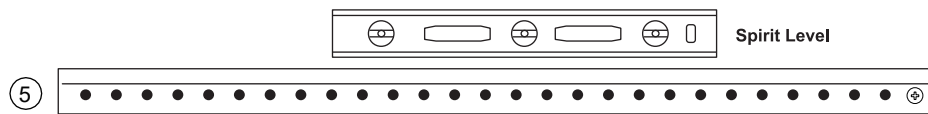

Use a level to ensure the hang track is horizontal.

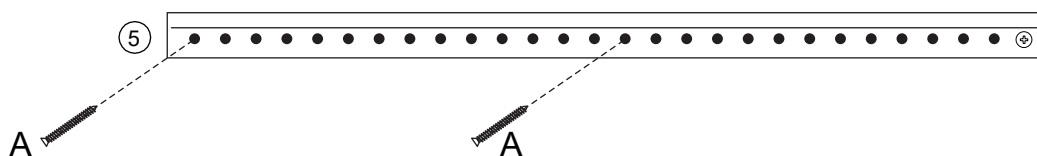

Then secure the remaining screws of the hang track.

warning: please pay attention to the type of screws dependant on whether it is plaster board only or stud wall.

**STEP 7** Hanging the wall strip onto the hang track and positioning into the wall strip install hole per as the beam sticker.

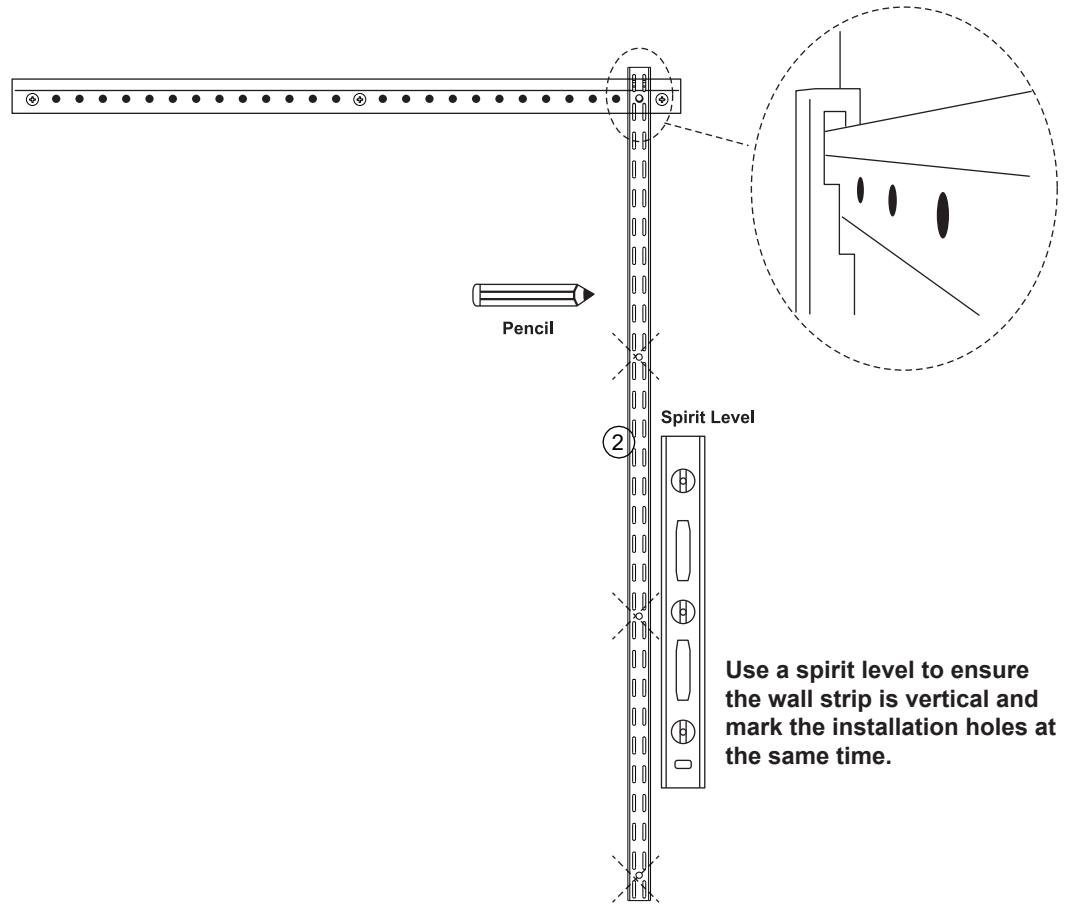

**STEP 8** Drill the correct holes according to the marked positions.

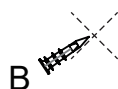

note: when install with stud, please use the type A screw .

**STEP 9** Secure the wall strip with screws.

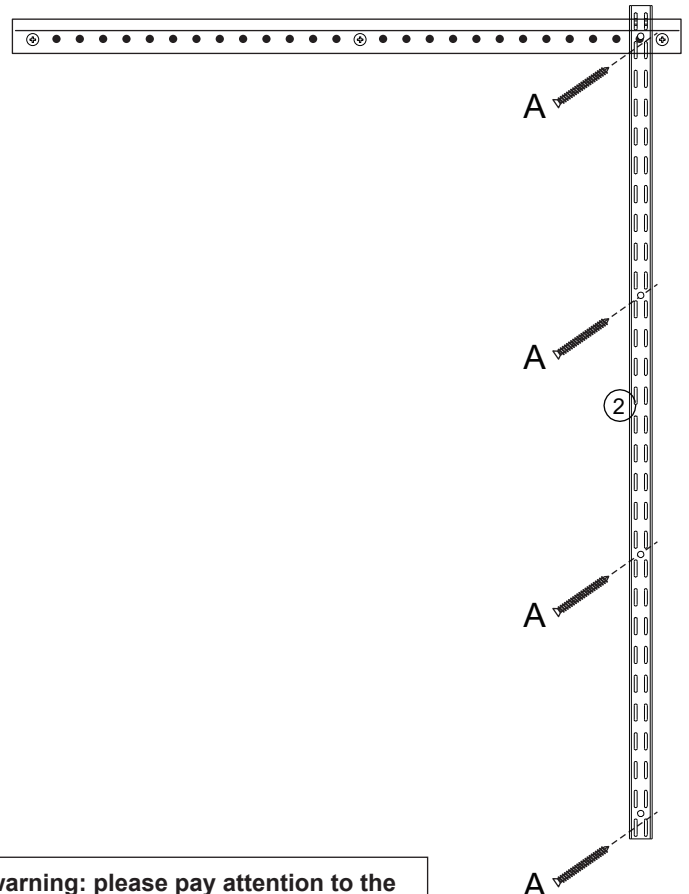

warning: please pay attention to the type of screws dependant on whether it is plaster board only or stud wall.

**STEP 10** Hanging the wall strip onto the hang track and positioning into the wall strip install hole per as the beam sticker.

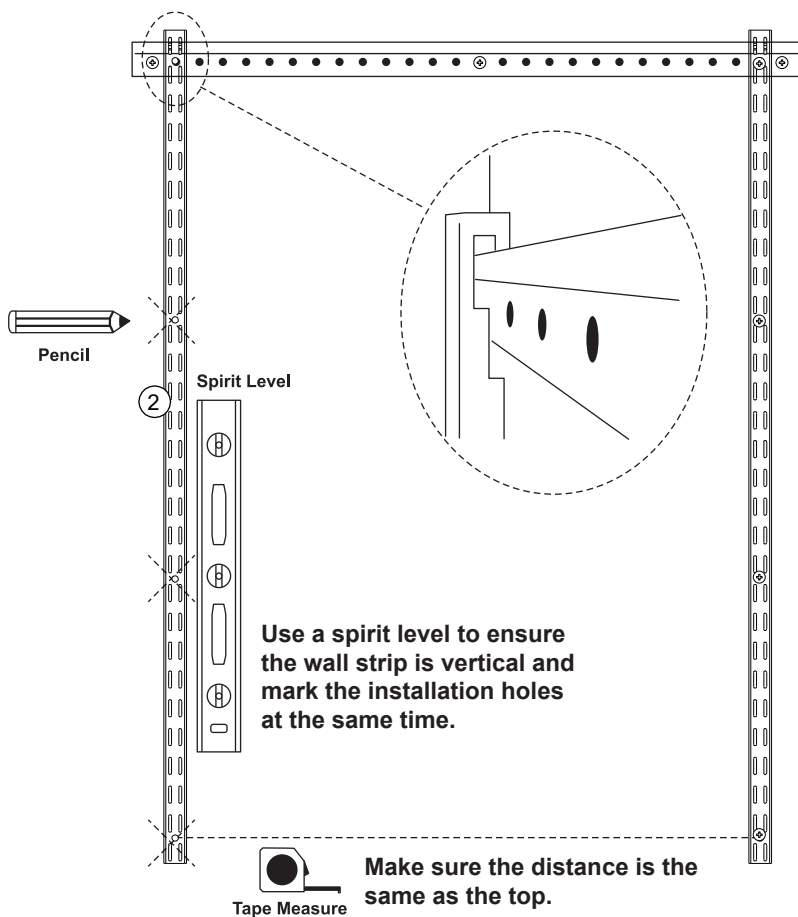

Note: please measure the distance before drilling the holes and make sure the distance between the centers of the installation holes is 59cm.

**STEP 11** Drill the correct holes according to the marked positions.

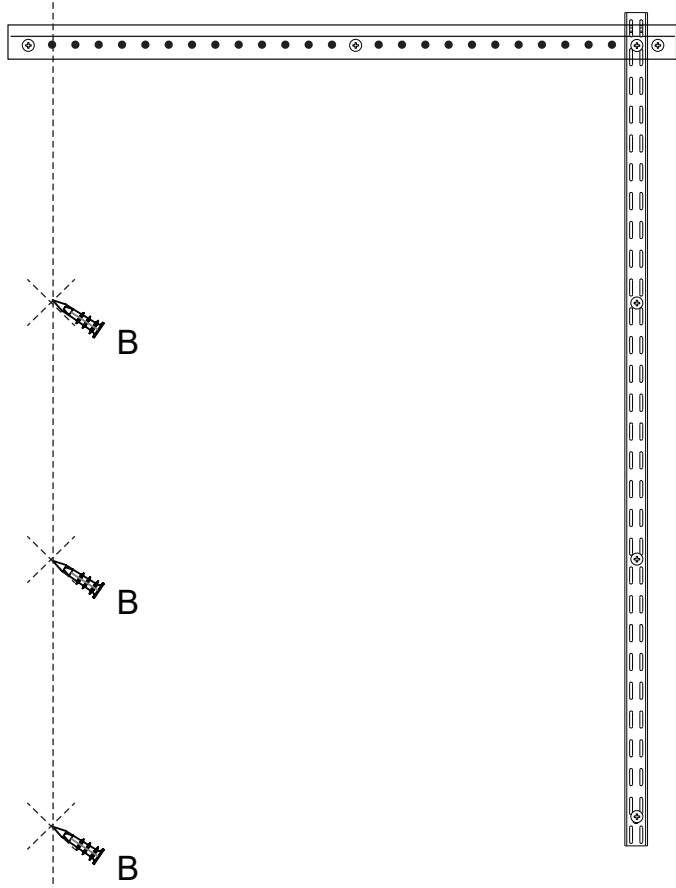

**STEP 12** Secure the wall strip with screws.

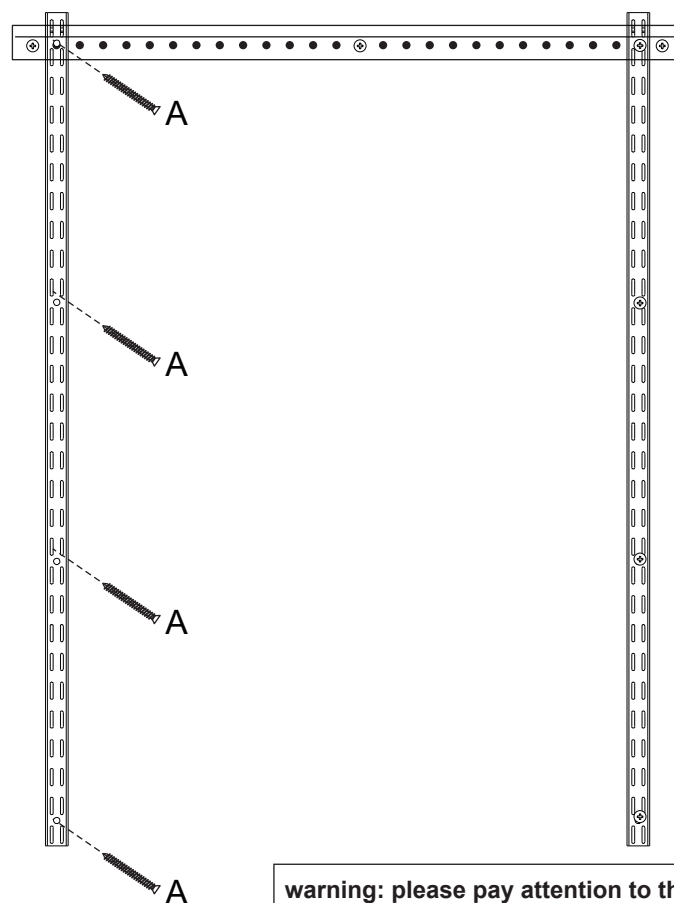

note: when install with stud, please use the type A screw .

warning: please pay attention to the type of screws dependant on whether it is plaster board only or stud wall.

**STEP 13** Use a connector to attach the lower part of the wall strip.

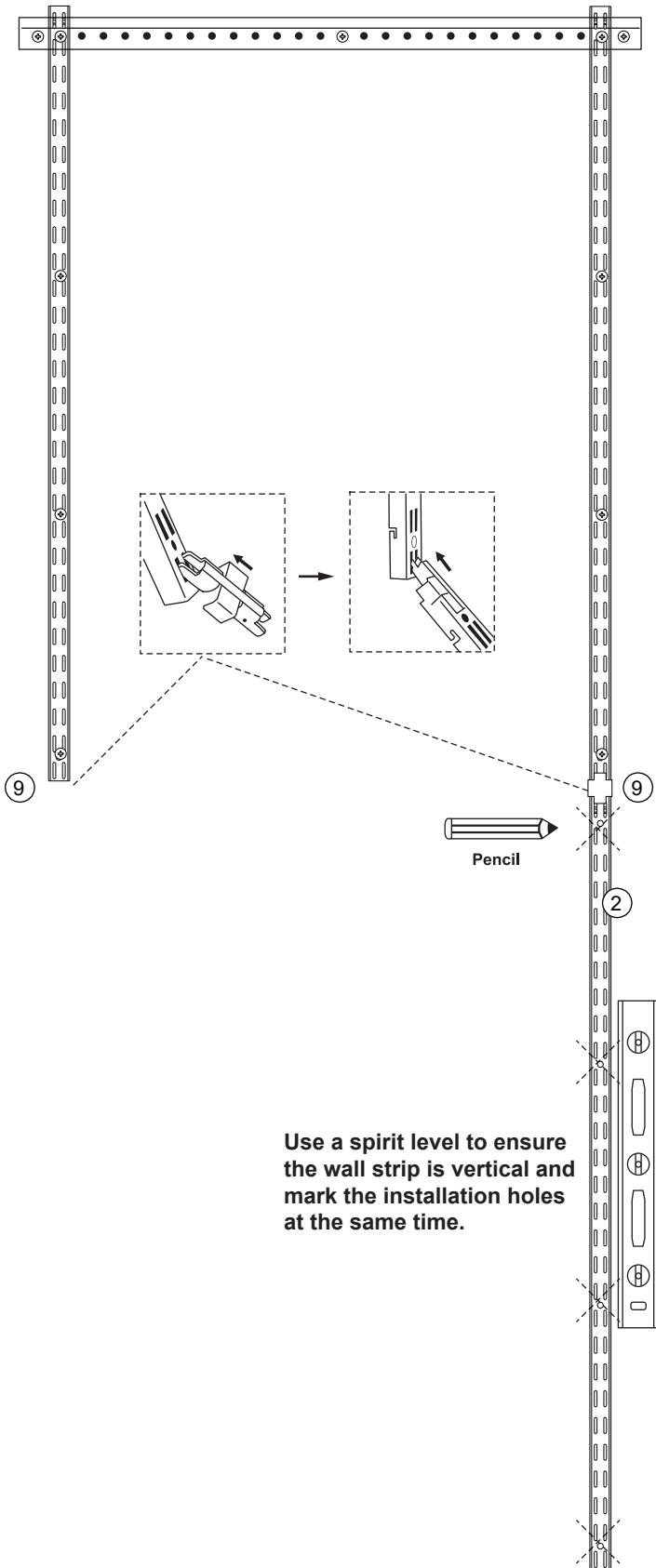

**STEP 14** Remove the lower wall strip and drill holes at the marked locations, according to your wall type.

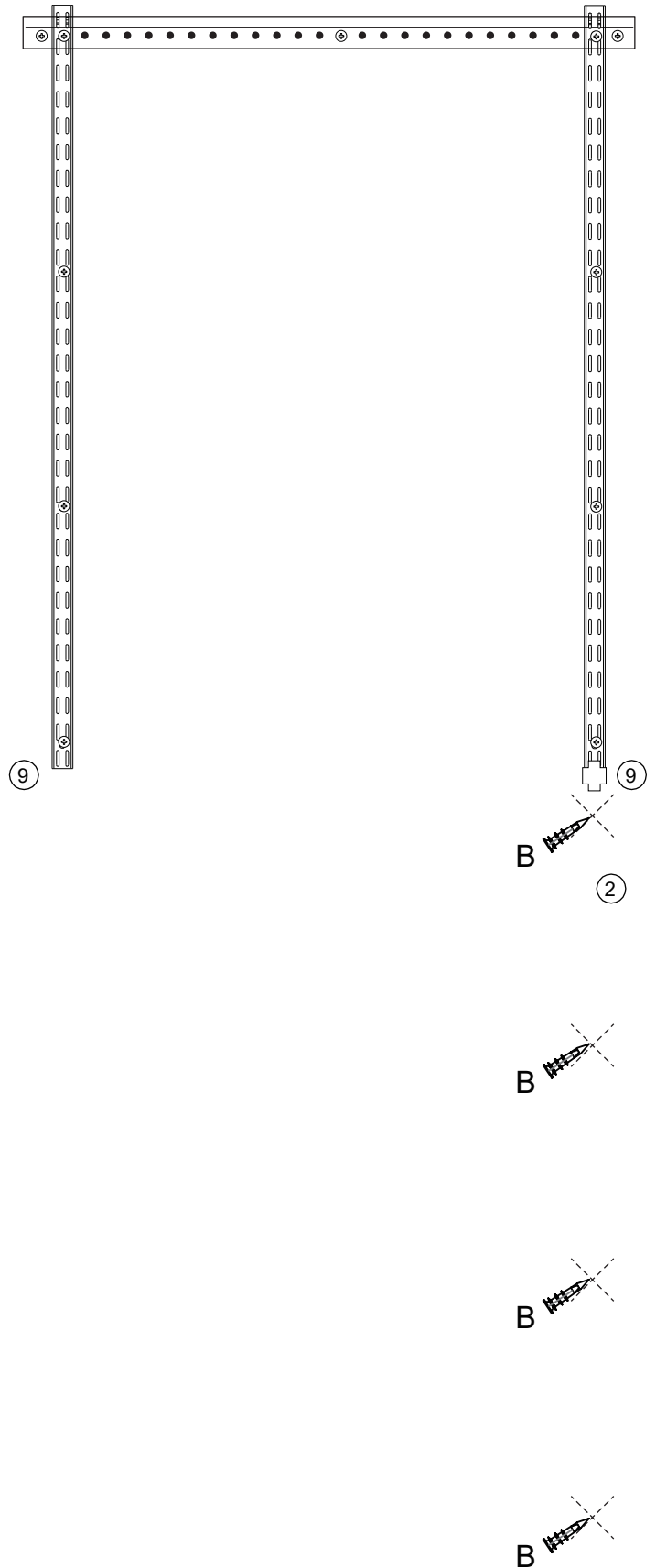

**note:** when install with stud, please use the type A screw .

**STEP 15** Secure the wall strip with screws.

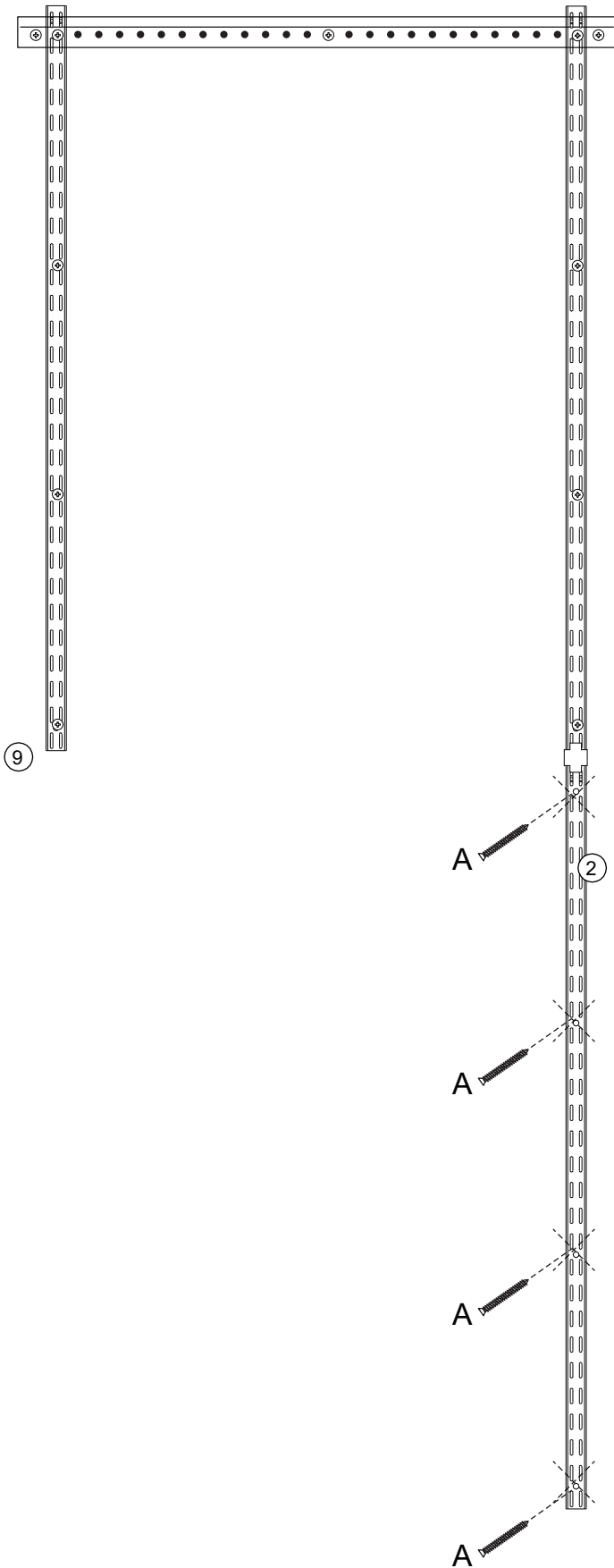

**warning:** please pay attention to the type of screws dependant on whether it is plaster board only or stud wall.

**STEP 16**

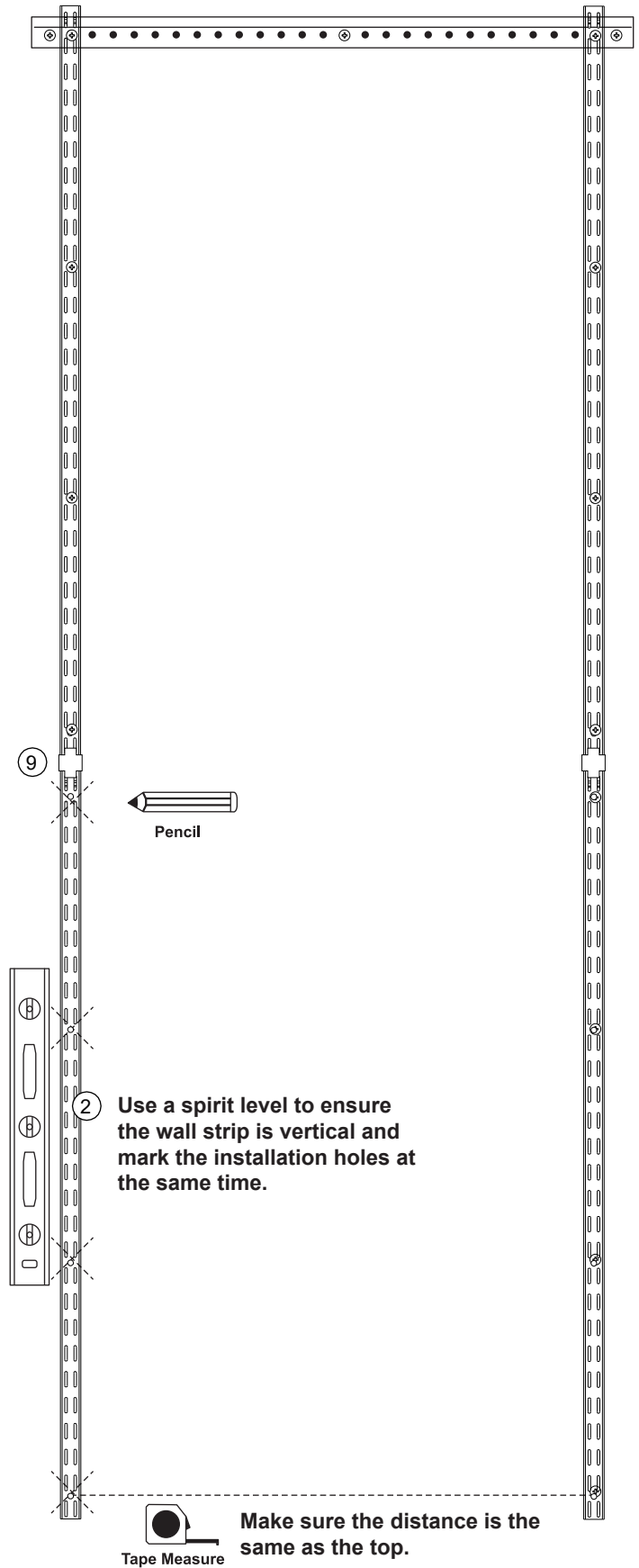

Pencil

Use a spirit level to ensure the wall strip is vertical and mark the installation holes at the same time.

Tape Measure

Make sure the distance is the same as the top.

**Note:** please measure the distance before drilling the holes and make sure the distance between the centers of the installation holes is 59cm.



**STEP 17** Remove the lower wall strip and drill holes at the marked locations, according to your wall type.

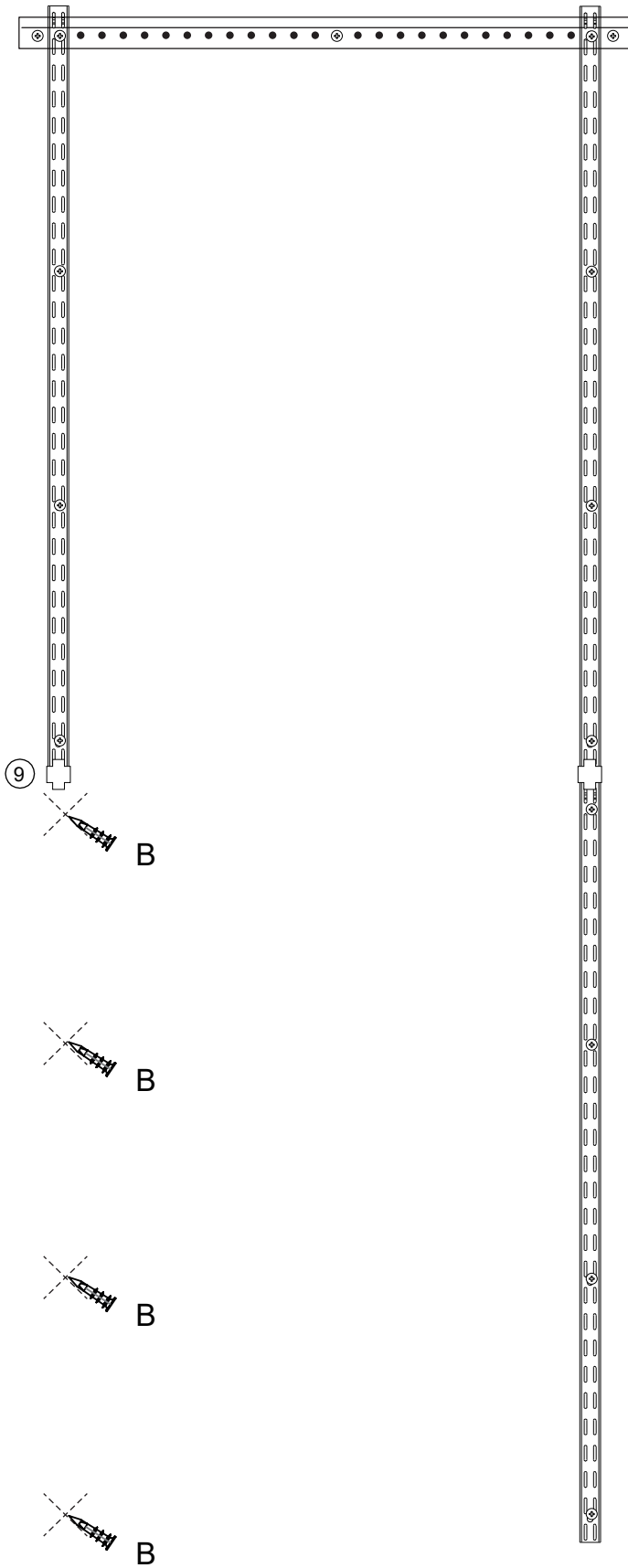

note: when install with stud, please use the type A screw .

**STEP 18** Secure the wall strip with screws.

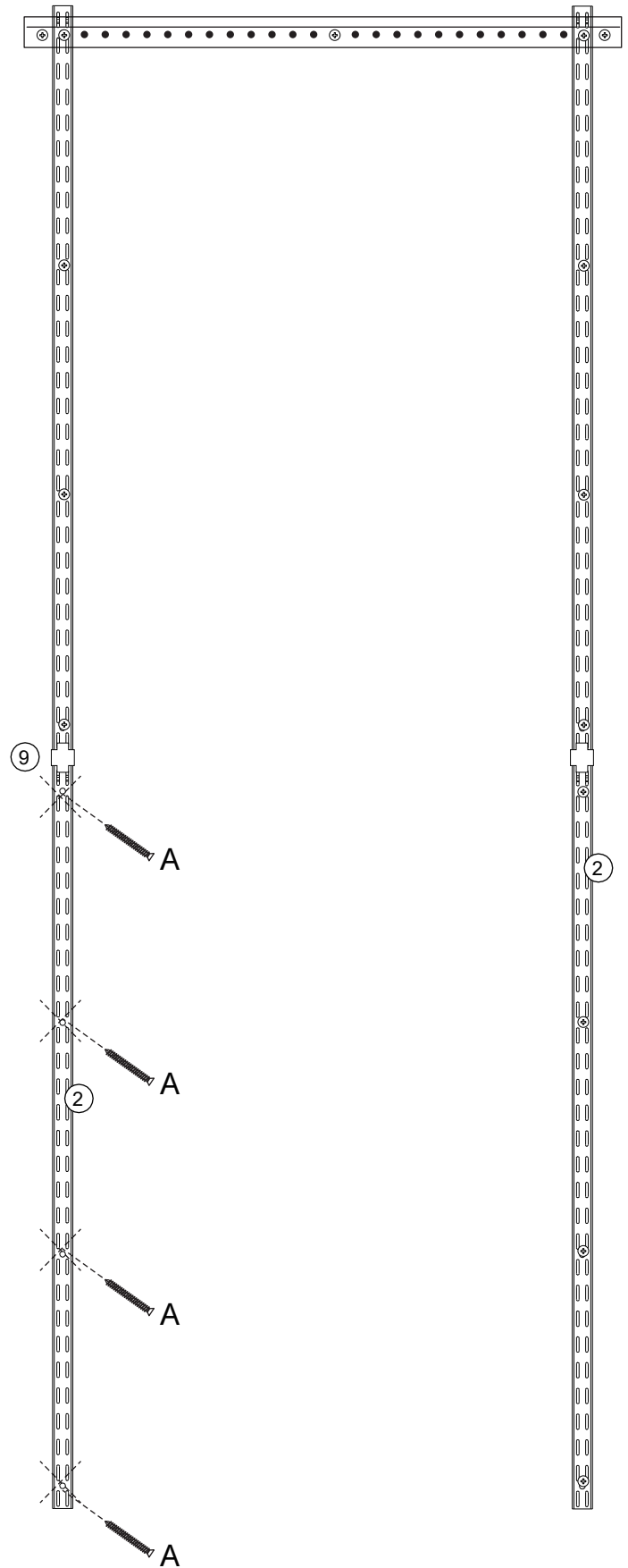

warning: please pay attention to the type of screws dependant on whether it is plaster board only or stud wall.

**STEP 19** Install the left and right brackets and apply a downward push to ensure it is locked in place.

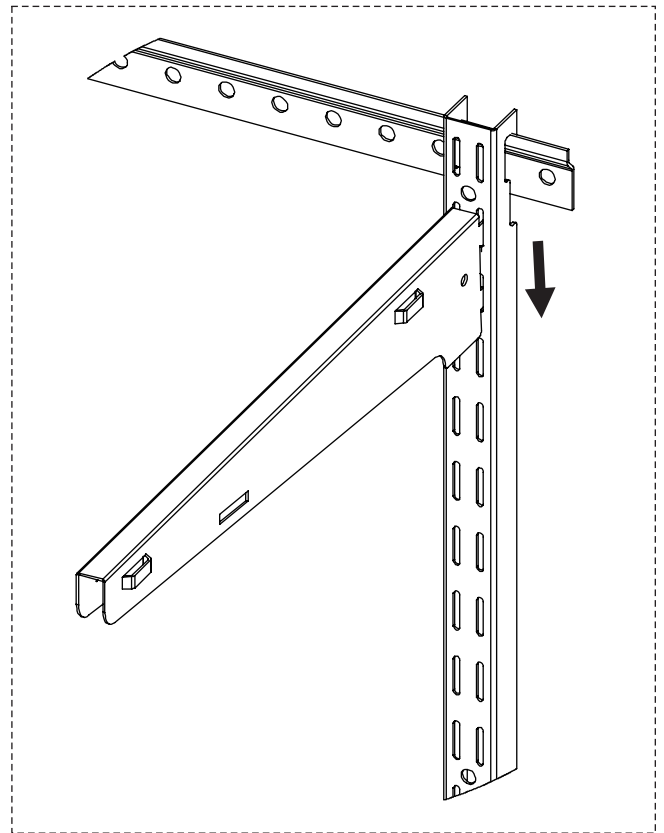
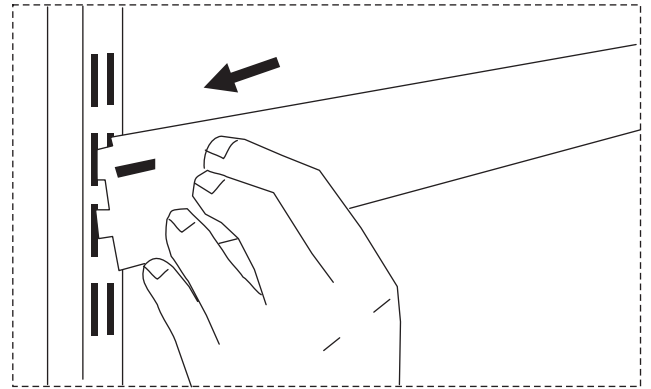
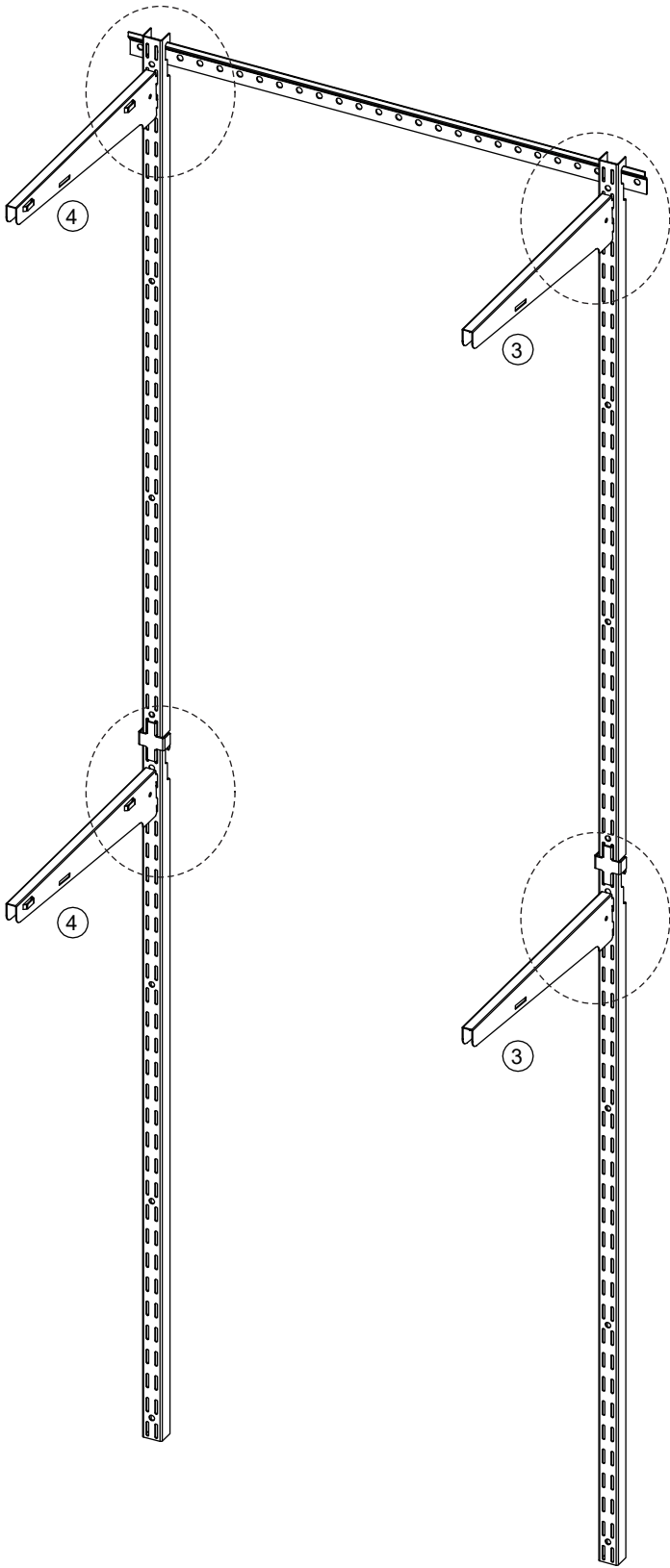

**STEP 20** Install the wire shelf and ensure that the snaps underneath the wire shelf engage with the notches. Secure the wire shelf and give it a push to ensure it is locked in place. When the wire shelf is locked, the front end is flush.

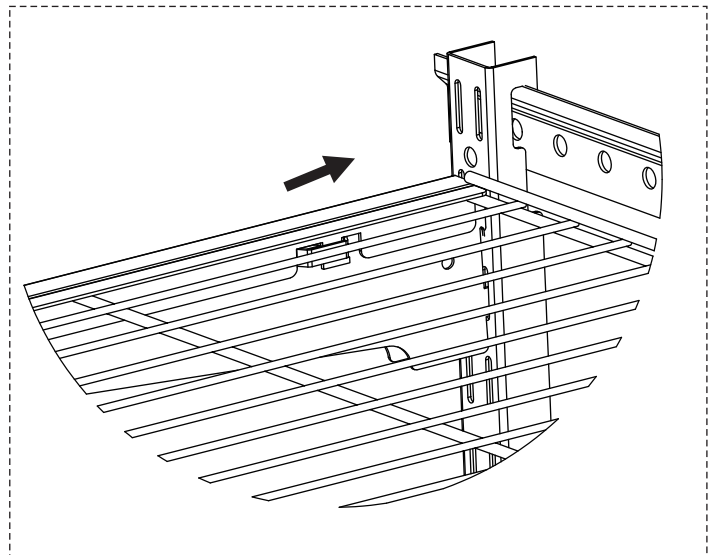
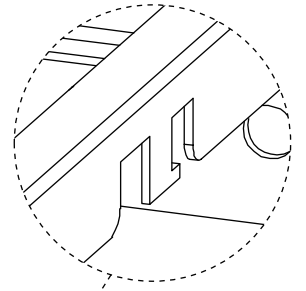
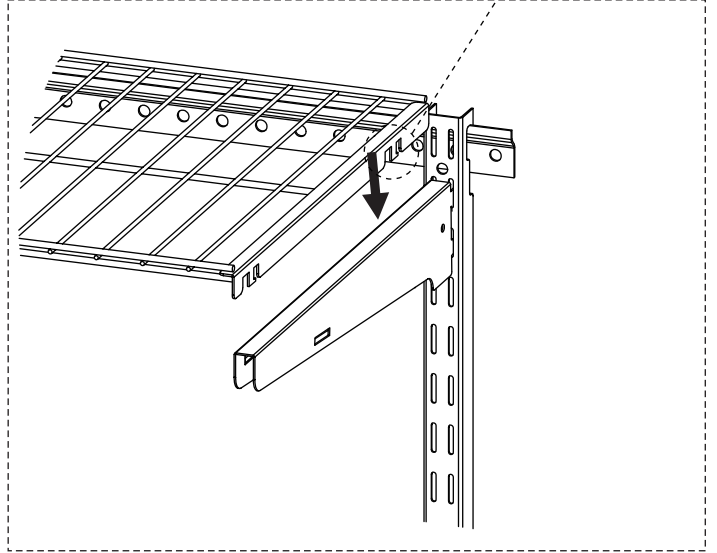
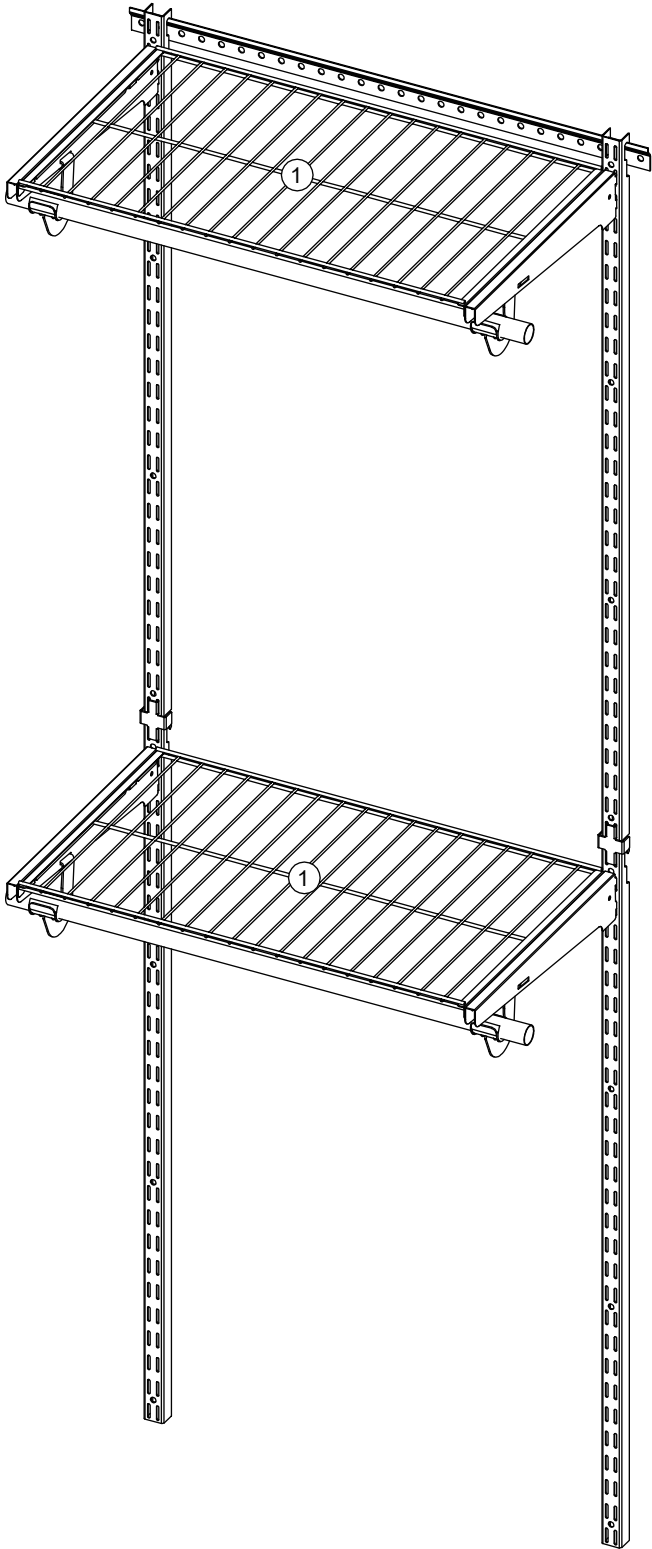

**STEP 21** hanger Installation: attach the hanger hook on the opening of the bracket, then install the hanger rail on the hook. Please ensure that hanger rail is securely installed and tightly fastened. Please seek professional advice if in doubt.

