

Assembly Instruction

43474240 WILLOW SIDE TABLE

CARE INSTRUCTIONS:





WIPE CLEAN WITH A SOFT DAMP CLOTH. DO NOT USE ABRASIVE MATERIALS AND SOLVENTS. CHECK AND TIGHTEN ALL PARTS REGULARLY. DO NOT PLACE HOT ITEMS SUCH AS COFFEE CUPS DIRECTLY ON THE SURFACE. KEEP AWAY FROM WATER AND DIRECT SUNLIGHT. STORE IN A DRY PLACE. FOR DOMESTIC USE ONLY. FOR INDOOR USE ONLY. A MILD ODOUR MAY BE PRESENT WHEN FIRST OPENING THIS CARTON. SIMPLY ALLOW TO AIR OUTSIDE AND THIS WILL FADE.

WARNING:

DO NOT STAND OR SIT ON THIS UNIT. DO NOT USE THIS UNIT UNLESS ALL BOLTS AND SCREWS ARE FIRMLY SECURED. DO NOT KNOCK OR DRAG THIS UNIT. USE ONLY ON A FLAT SURFACE. LOAD TOP EVENLY TO PREVENT FROM TIPPING OVER. THIS PACKAGE CONTAINS SMALL PARTS AND SHARP POINTS. KEEP AWAY FROM CHILDREN AND BABIES. ADULT ASSEMBLY REQUIRED. FAILURE TO FOLLOW THESE WARNINGS COULD RESULT IN SERIOUS INJURY.

MAXIMUM SAFE LOAD: 10KG FOR TABLE TOP.

Hardware List

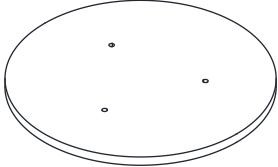
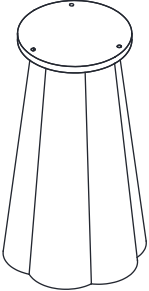

	A	6x16mm	3pcs
	B		3pcs
	C	4mm	1pc
	D	Felt Foot Pad	6pcs

Part List

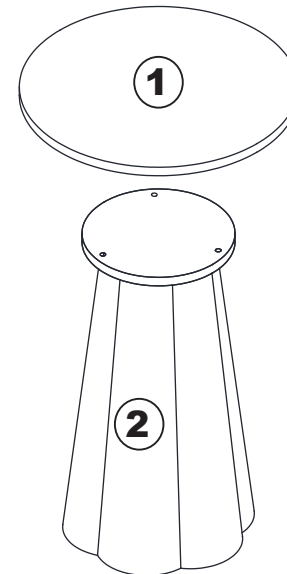
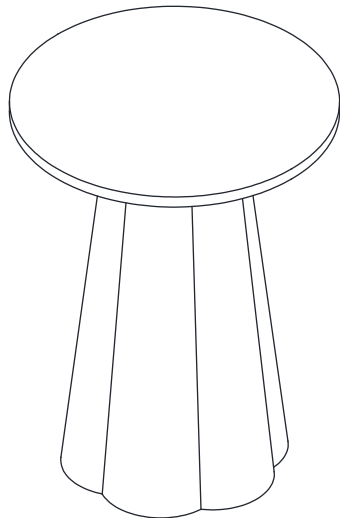
			
①	1 PC	②	1 PC



Do not tighten the screws fully during assembly.
Fully tighten screws after the final assembly steps.

Step 1:  A x 3  B x 3  C x 1

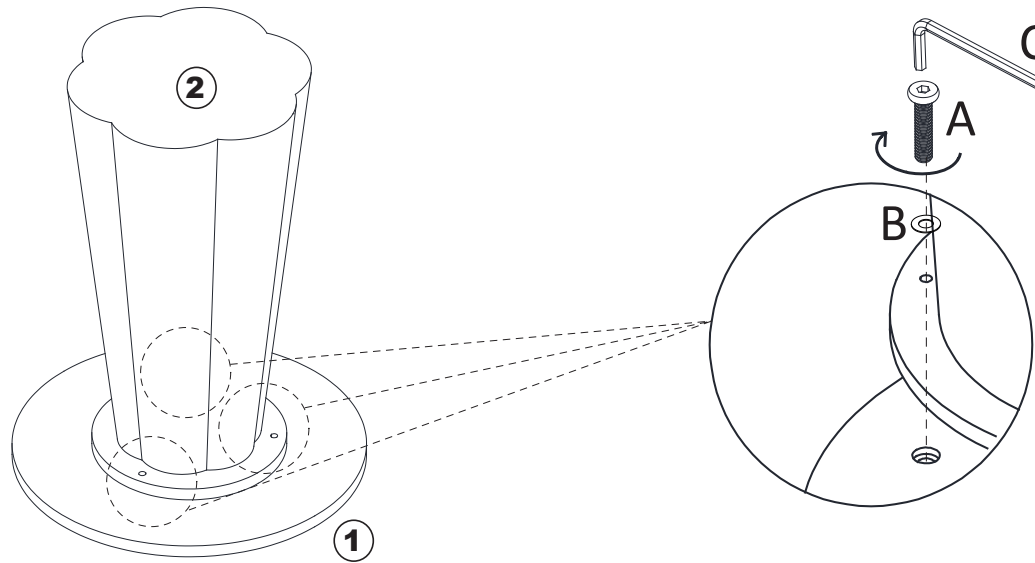

NOTE: Lock 50% A bolt first to the top panel ①, when another two A bolts are well aligned with top panel ①, then lock tight 100%.

Step 2:  D x 6

