

















anko

Cat Tower Jungle



Contents

1  1PC SIZE 600mm*400mm*20mm	2  1PC SIZE 400mm*260mm*15mm	3  1PC	4  1PC SIZE 310mm*310mm*12mm	5  1PC
6  3PCS SIZE L=215mm	7  1PC SIZE L=220mm	8  2PCS SIZE L=230mm	9  1PC SIZE L=300mm	10  1PC
11  1PC SIZE 290mm*290mm*15mm	12  1PC SIZE 280mm*280mm*12mm			

Accessory	Size	Quantity
A 	6mm*35mm	6pcs
B 	8mm*80mm	2pcs
C 	8mm*35mm	4pcs
	5mm	1pc

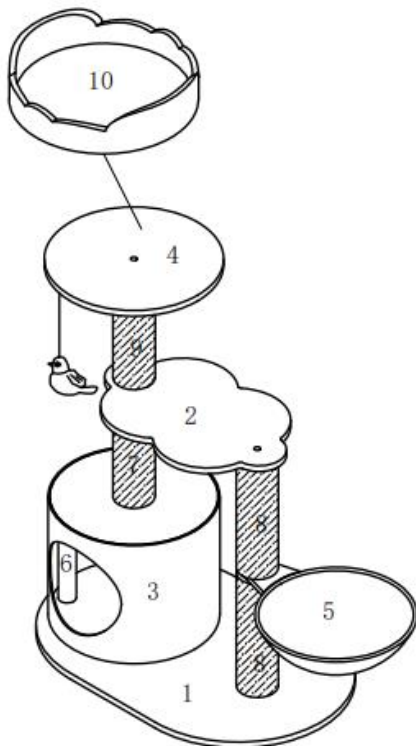

Assembly Instructions

Step 1.

Use the allen key and screws A, to screw poles No.6 onto board No.11 and board No.12. Then put cover No.3 on top to assemble. Then put the assembled part onto board No.1 by using screw C. Please refer to the image below:

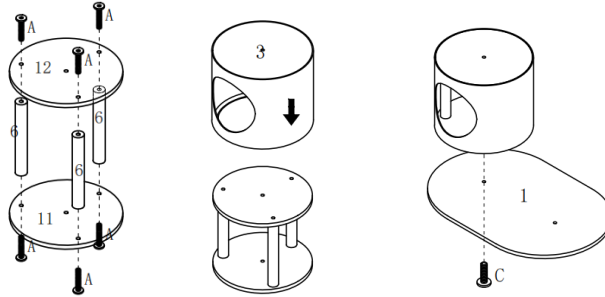

Step 2.

Use the allen key and screws C, to screw pole No.7 on top of cave No.3. Then using screws C, screw one pole No.8 onto board No.1. Please tighten screws at this step. Refer to the image below:

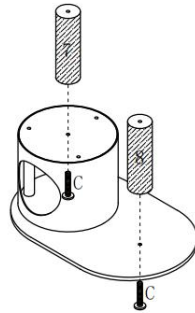

Step 3.

Align bed No.5 on top of the pole, insert screw B and then place another pole No.8. on top Refer to the image below:

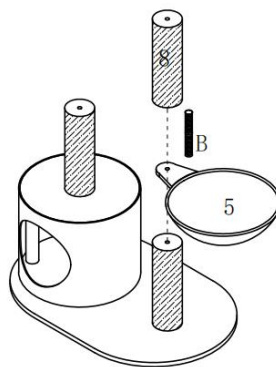

Step 4.

Align board No.2 on top of the two poles, as per below image. Then using screws B and C to connect. Then place pole No.9 on top of screw B. Refer to the image below:

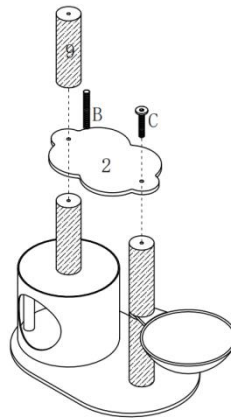

Step 5.

Screw board No.4 onto pole No.9 as below image, then put cave cover No.10 on board No.4.

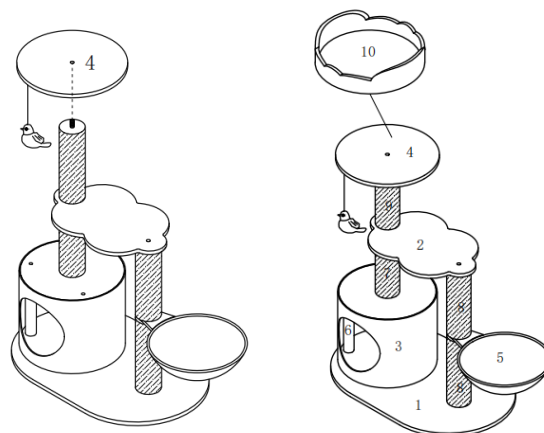

WARNING:

**For your pet's safety, inspect regularly and remove if damaged.
Always supervise your pet during play.**