











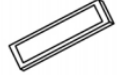

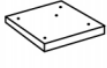

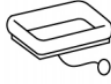

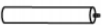

anko

Cat Tower 3 Level



Contents

① 480×480mm (1pc) 	② 480×480mm (1pc) 	③ 170×460mm (1pc) 	④ (1pc) 
⑤ 295×295mm (1pc) 	⑥ (1pc) 	⑦ (1pc) 	⑧ (1pc) 
⑨ 400mm (1pc) 	⑩ 400mm (1pc) 	⑪ 400mm (1pc) 	⑫ 400mm (1pc) 
⑬ 320mm (1pc) 	⑭ 200mm (1pc) 	⑮ 270mm (4pcs) 	

Accessories	Size	Quantities
 A	\	1
 B	8×35mm	13
 C	8×80mm	2
 D	6×16mm	4
 E	\	2

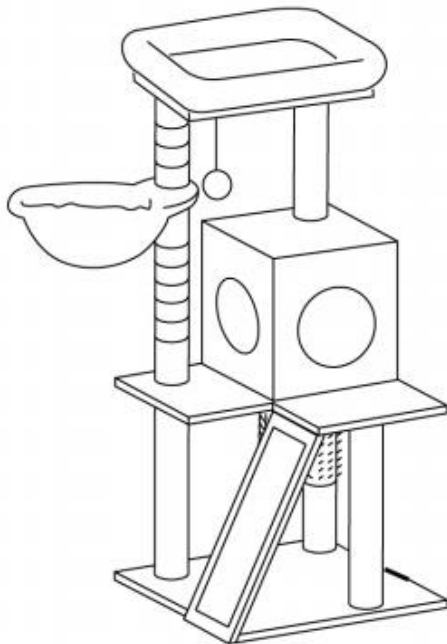

Assembly Instructions

Step 1.

Screw in poles No.13 and No.14 to top bed No.8 tightly. For pole placement please refer to the image below:

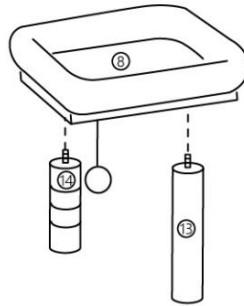

Step 2.

Using the allen key and screws B, screw poles No.15 into board No.2. Then place board No.5 on top of poles No.15 and screw in with screws B. Then put cover No.4 on top of board No.5. Refer to the image below:

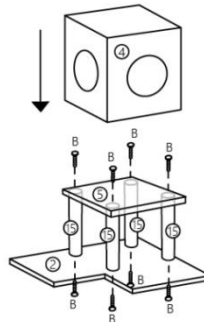

Step 3.

Insert screw C through the bottom of board No.2 to attach pole No.9. Then put pet bed No.7 using screw C onto pole No.9. Using the allen key and screws B screw top bed No.8. to the base structure. Refer to the image below:

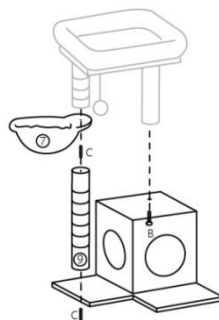

Step 4.

Screw rope No.6 and pole No.10 to the bottom of board No.2. Then insert screw C into pole No.11 to attach to the bottom of board No.2. Using the allen key and screws B, screw pole No.12. to the bottom of board No.2. Refer to the image below:

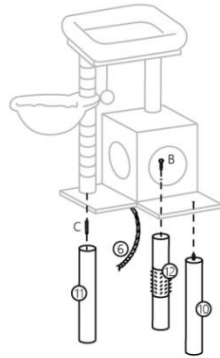

Step 5.

Using the allen key and screws B to connect board No.1 to poles No.10, No.11 and No.12. Take the allen key again and screws C to screw the angle irons E on the inside of the scratcher No.3. and Board No.2 to connect. Refer to the image below:

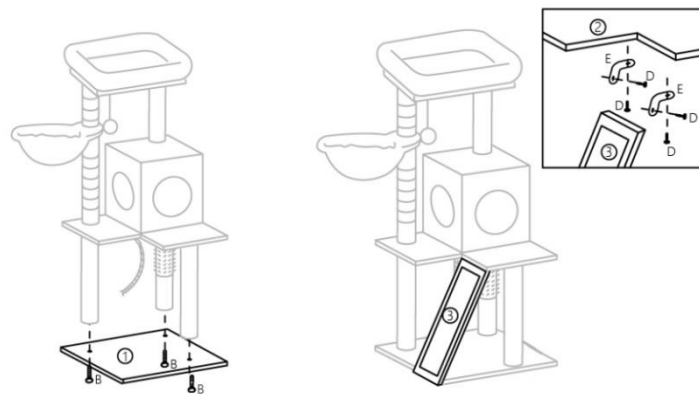

WARNING:

**For your pet's safety, inspect regularly and remove if damaged.
Always supervise your pet during play.**