

Assembly Instructions

K: 43522606 | T: 70719499 WAVE SHELF

CARE INSTRUCTIONS:









WIPE CLEAN WITH A DRY CLOTH. DO NOT USE ABRASIVE MATERIALS AND SOLVENTS. CHECK AND TIGHTEN ALL PARTS REGULARLY. KEEP AWAY FROM WATER AND DIRECT SUNLIGHT. DO NOT PLACE HOT ITEMS SUCH AS COFFEE CUPS DIRECTLY ON THE SURFACE. STORE IN A DRY PLACE. FOR INDOOR AND DOMESTIC USE ONLY

WARNING:

DO NOT STAND OR SIT ON THIS ITEM. DO NOT USE UNTIL ALL SCREWS ARE FIRMLY SECURED. ADULT ASSEMBLY REQUIRED. SEEK ASSISTANCE FROM A DIY EXPERT IF YOU ARE UNSURE HOW TO HANG. FAILURE TO FOLLOW THESE WARNINGS COULD RESULT IN SERIOUS INJURY AND DAMAGE TO PROPERTY.

MAXIMUM LOADING WEIGHT: 3KG FOR SHELF.



Hardware list

	A		4PCS		B		4PCS		C	6×30mm	2PCS		D	5×40mm	4PCS
	E	4×35mm	2PCS		F		2PCS		G		1PC		H		4PCS

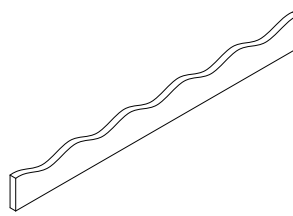
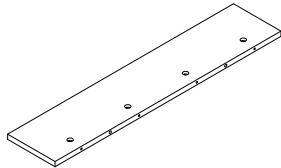
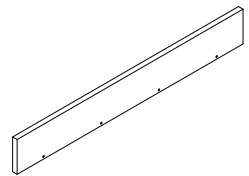

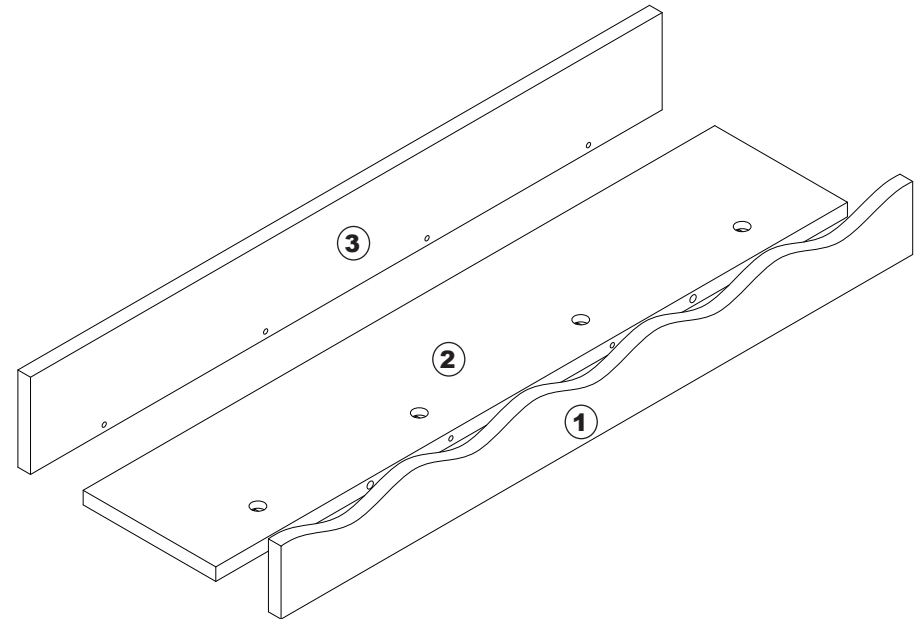
Parts List

	1	1PC		2	1PC		3	1PC
--	----------	-----	--	----------	-----	--	----------	-----



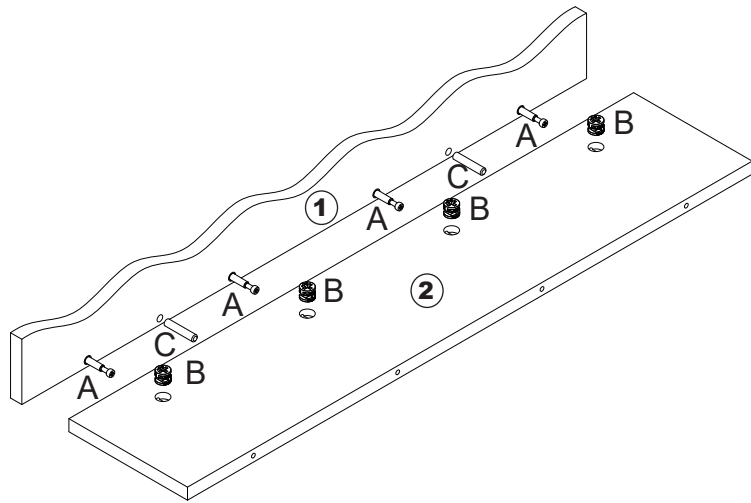

STEP 1 A-x4 B-x4 C-x2

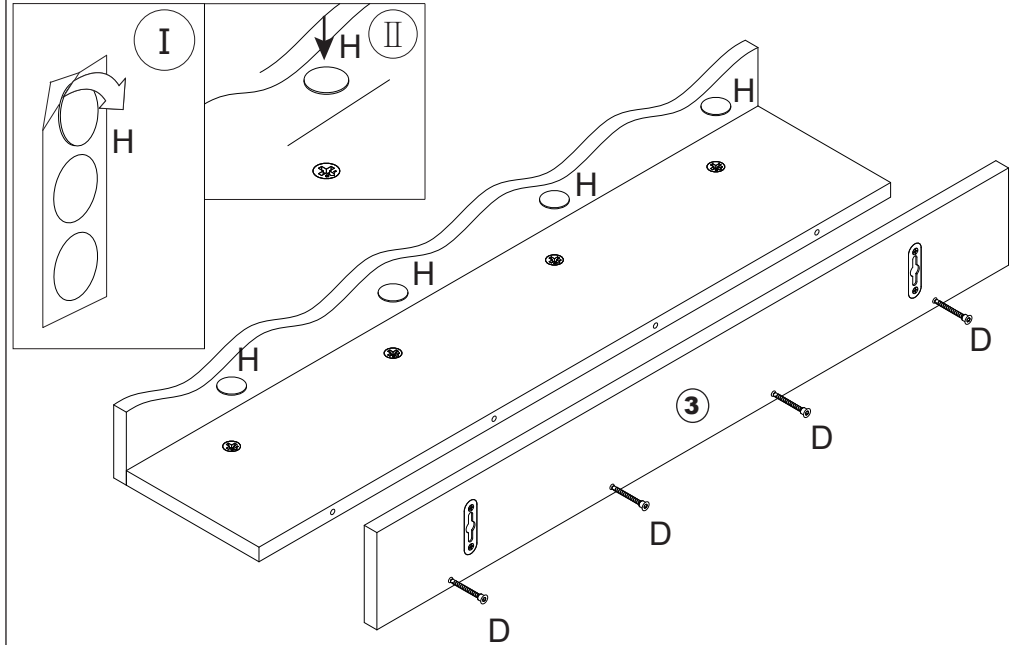

STEP 2 D-x4 H-x4



STEP 3 E-x2 F-x2

