

home
&CO

**Steam Iron
User Manual**



Model: KB-166E2

IMPORTANT SAFETY INSTRUCTIONS

Read this user manual carefully before first use and save it for future reference.

- This appliance is not intended for use by persons (including children) with reduced physical, sensory or mental capabilities or lack of experience and knowledge, unless they have been given supervision or instruction concerning use of the appliance by a person responsible for their safety.
- Children should be supervised to ensure that they do not play with the appliance.
- Cleaning and user maintenance shall not be made by children without supervision.
- This product has been designed for domestic use only. In case of any commercial use, inappropriate use or failure to comply with the instructions, the manufacturer is not responsible and the guarantee will not apply.
- Before connecting your appliance, check if the mains voltage is the same as the voltage indicated on your appliance and that the power outlet is connected to the earth.
- Ensure before each use that the electric cord or any other important part is not damaged.
- Keep the iron and its cord out of reach of children when it is energized or cooling down.
- Never direct the steam towards persons or animals. Never direct the steam jet towards any other electrical or/and electronic appliances.
- The iron is not to be used if it has been dropped, if there are visible signs of damage or if it is leaking.
- If the appliance shows evidence of breakdown, malfunction, water leaks or other abnormality, do not use.
- Always make sure the appliance is switched off, unplugged and cooled down before doing any maintenance work.
- **IMPORTANT!** This iron must not be left unattended while it is connected to the supply mains and before it has cooled down.
- Do not unplug the appliance by pulling on the cord or on the appliance.
- Never immerse the iron, the stand, the cable or the plug in water. Never hold them under the water tap.
- The soleplate of the iron can become extremely hot and may cause burns if touched. Do not allow the supply cord to come in contact with the soleplate.
- If the supply cord is damaged, it must be replaced by qualified electrical person only or the product must be disposed of.
- Disconnect from mains power when filling the reservoir in the iron with water.
- The iron must be used and rested on a flat, stable surface.
- Always place and operate the iron on a flat, solid, clean and dry surface. When placing the iron on its stand, ensure that the surface on which the stand is placed is stable.
- For additional protection, this appliance should be connected to a household residual current device (safety switch) with a rating of no more than 30mA. If unsure consult your electrician for advice.

BEFORE FIRST USE

Unpack the appliance and check if all parts are there and undamaged. Should this not be the case, return the product to Kmart for replacement.

The packaging contains:

- One steam iron
- One filler cup

Clean all parts before first use. See **Cleaning and Maintenance**

Heat up the iron to its maximum temperature and iron over a piece of damp cloth for several minutes. This will burn-off any manufacturing residue from the iron. Smoke and odour may occur for a short period during this process, which is normal.

FEATURES

Your iron has an Auto-Off function.

Auto-Off function: Automatically switches off the steam iron if it has not been moved for a while. The indicator lamp will flash when in auto-off mode.

PARTS

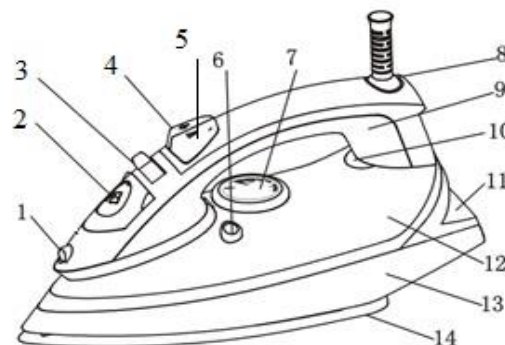

1. SPRAY NOZZLE
2. FILLING COVER
3. STEAM CONTROL
4. BURST BUTTON
5. SPRAY BUTTON
6. SELF-CLEAN BUTTON
7. TEMP. DIAL

8. CORD GUARD
9. HANDLE
10. INDICATOR LAMP
11. REAR COVER
12. WATER TANK
13. SKIRT
14. SOLEPLATE



OPERATION

Filling the water tank



- Ensure that the iron is cold and not connected to a power supply.
- Open the water filling cover (2). Hold the iron in a tilted position and fill the tank with plain water, using the filler cup.
- DO NOT exceed the max level on the tank.
- Close the water filling cover (2) by pressing down the cap until you hear a click. To avoid water spillage, ensure that the water tank is properly closed.

NOTES:

To avoid calcium deposits, we recommend you use distilled water for your steam iron.

To avoid damage or blockage of your steam iron, do not use any scented water or additives.

Steam Ironing

- Fill the water tank
- Position the iron vertically on its stand on a suitable flat stable surface.
- Ensure that the steam control (3) is on OFF position
- Connect the plug to a suitable power outlet.
- Turn the temperature dial (7) to a setting within the steam range  • • • MAX .
- The indicator lamp (10) will light up. The light will turn off as soon as the selected temperature is reached.
- Turn on the steam control (3)  and begin ironing.

Dry Ironing

- Position the iron vertically on its stand on a suitable flat stable surface.
- Ensure that the steam control (3) is on OFF position
- Connect the plug to a suitable power outlet.
- Turn the temperature dial (7) to a desired setting
- The indicator lamp (10) will light up. The light will turn off as soon as the selected temperature is reached.
- Now dry ironing can begin.

Using the spray button

- Press the spray button a couple of times to moisten the garment. Before spraying make sure that there is enough water in the water tank.

NOTE: Do not spray water on silk.

Using the steam shot button

- Press the steam shot button to instantly provide a powerful burst of steam to eliminate stubborn wrinkles. Steam shot can be activated when temperature setting is in the steam range.
- The steam shot button can also be applied when holding the iron in a vertical position. This is useful for removing creases from hung clothes, curtains, etc.

ATTENTION: To protect against burns or injury to persons, do not iron or steam fabrics while being worn on the body. Do not direct steam towards the body when ironing.

After ironing

- After use, turn the temperature dial (7) to MIN and disconnect the iron from mains power outlet.
- Let the iron cool down and empty the water tank.

CLEANING AND MAINTENANCE

Unplug the iron from mains power and allow it to cool down completely before cleaning and storing.

Cleaning

- Clean the upper part of iron with a damp cloth. If necessary, use a mild detergent.
- Do not use alcohol, acetone, benzene, scouring cleaning agents, etc., to clean the iron. Do not use hard brushes or metallic objects.
- Remove any deposits on the soleplate with a damp cloth. To avoid scratching the finishing, never use a metallic pad to clean the soleplate, and never place the iron on a rough surface.
- To remove synthetic residue from the soleplate, iron over an old cotton rag in high setting.

- Always store the emptied iron horizontally on a stable surface with a cloth protecting the soleplate.

Self-clean function





The self-cleaning function should be used on a regular basis, depending on usage and the hardness of water used.

WARNING: Never pour white vinegar or any liquid cleaners into the water tank!

- Fill the water tank. **Refer to OPERATION: Filling the water tank.**
- Position the iron vertically on its stand on a suitable surface.
- Ensure that the steam control (3) is in OFF position.
- Connect the plug to a suitable power outlet.
- Set to maximum ironing temperature.
- Once the soleplate temperature is reached, unplug the iron from the mains.
- Hold the iron over a sink, *pull* and *hold* the self-clean button (6). Boiling water and steam will now emit from the holes in soleplate.
- Carefully shake the iron forwards and backwards to allow any scale and other deposits being expelled with the boiling water and the steam.
- Release the self-clean button (6) when the water tank is empty.
- Plug the appliance into the mains socket, set a temperature and leave in operation for at least two minutes to dry the soleplate.
- Unplug the iron and let the iron cool down fully.

IRONING TIPS

- Before you start ironing, always check whether a label with ironing instructions is attached to the garment. Follow these ironing instructions in any case.
- The iron heats up quicker than it cools down, therefore, you should start ironing the articles requiring the lowest temperature such as those made of synthetic fibre.
- If the fabric consists of various kinds of fibres, you must always select the lowest ironing temperature to iron the composition of those fibres.
- Silk and other fabrics that are likely to become shiny should always be ironed on the inner side. To prevent staining, do not spray water straight on silk or other delicate fabrics.
- To prevent staining, do not spray water straight on silk or other delicate fabrics.
- Velvet and other textures that rapidly become shiny should be ironed in one direction with light pressure applied. Always keep the iron moving at any moment.
- Pure wool fabrics (100% wool) may be ironed with the iron set to steam position. Preferably set steam button to the maximum position and use a dry cloth between the garment and the iron for protection.
- Do not touch plastic buttons with a hot iron because they may melt.
- Be careful around zippers and similar items to prevent the soleplate from scratching.

Symbol	Fabric	Temperature setting	Variable steam	Steam shot	Spray
	Synthetic fiber	MIN ●	✗	✗	✓
	Wool, Silk	● ●	✗	✗	✓
	Cotton, Linen	● ● ● MAX	✓	✓	✓
	Attention! This symbol indicates: DO NOT IRON!				✓ possible ✗ not possible

TECHNICAL DATA

Rated voltage: 220-240V~ 50Hz
Rate power: 1800-2200W

12 Month Warranty

Thank you for your purchase from Kmart.

Kmart Australia Ltd warrants your new product to be free from defects in materials and workmanship for the period stated above, from the date of purchase, provided that the product is used in accordance with accompanying recommendations or instructions where provided. This warranty is in addition to your rights under the Australian Consumer Law.

Kmart will provide you with your choice of a refund, repair or exchange (where possible) for this product if it becomes defective within the warranty period. Kmart will bear the reasonable expense of claiming the warranty. This warranty will no longer apply where the defect is a result of alteration, accident, misuse, abuse or neglect.

Please retain your receipt as proof of purchase and contact our Customer Service Centre on 1800 124 125 (Australia) or 0800 945 995 (New Zealand) or alternatively, via Customer Help at Kmart.com.au for any difficulties with your product. Warranty claims and claims for expense incurred in returning this product can be addressed to our Customer Service Centre at 690 Springvale Rd, Mulgrave Vic 3170.

Our goods come with guarantees that cannot be excluded under the Australian Consumer Law. You are entitled to a replacement or refund for a major failure and compensation for any other reasonably foreseeable loss or damage. You are also entitled to have the goods repaired or replaced if the goods fail to be of acceptable quality and the failure does not amount to a major failure.

For New Zealand customers, this warranty is in addition to statutory rights observed under New Zealand legislation.