

# anko

**Food Processor  
FP403  
User Manual**



**PLEASE READ AND SAVE THESE  
INSTRUCTIONS FOR FUTURE REFERENCE**

## **IMPORTANT SAFEGUARDS**

Before using the electrical appliance, the following basic precautions should always be followed including the following:

### **Electrical safety and cord handling**

- **Connection:** Only connect the appliance to a readily accessible electrical wall outlet, and make sure that your outlet voltage and circuit frequency correspond to the voltage stated on the rating label on the product.
- **WARNING: Protect from water!** To reduce the risk of electrocution, never operate this product with wet hands. Never immerse the product, its cord or plug in water or other liquid. Do not rinse the motor base under tap water.  
Do not place the appliance near a sink or basin so that the appliance, the mains plug and the power cord cannot accidentally come into contact with water. If the appliance, mains plug or cord falls into water, turn OFF the power immediately. Do not reach into the water!
- **Power cord:** Do not kink, bend, squash or damage the power cord, and protect it from sharp edges and heat. Do not let it hang over the edge of a table or bench top, or touch hot surfaces. Do not put any stress on the cord where it connects to the product, as the power cord could fray and break.
- **Cord handling:** Unwind the power cord completely before use. The cord should be run in such a way that there will be no risk of anyone pulling it inadvertently or tripping over it.
- **No extension cord:** Do not use an extension cord. Insert the plug directly into an electrical outlet.
- **No timer:** The appliance is not intended to be operated by means of an external timer or separate remote control system.
- **Power connection:** Do not plug the appliance into the power supply until it is fully assembled. **IMPORTANT! Always unplug the appliance from mains power before assembling/disassembling and when handling the blade.**
- **Disconnect:** Switch OFF the appliance and disconnect the plug from mains power outlet before cleaning the appliance, before putting on or taking off parts and when it is not in use. Grip the appliance supply cord by the plug, do not pull by the cord when disconnecting from mains power.
- **Damage:** Do not pick up or operate the appliance if the power supply cord, plug or housing is damaged, or after it malfunctions or has been damaged. If the supply cord is damaged, it must be replaced by qualified electrical person in order to avoid a hazard or the product must be disposed of.

### **Usage conditions and restrictions**

- **Domestic use only:** This appliance is intended for indoor household use only. Do not use it outdoors or in wet or damp environments, or expose it to extreme temperatures.
- **Intended use:** This product is intended solely for non-commercial processing of foods for human consumption. Do not use the product for any other purpose, and only use it as described in this manual. Any other use is not recommended, and may expose you to danger and/or void the warranty.
- **Work surface:** Place the appliance on a stable, level and dry work surface.
- **Protect from heat:** Do not place it on a surface that can become hot, such as on a cook top, near a gas stove or in a heated oven.
- **Use of accessories:** The use of accessories that are not supplied with the product by the appliance manufacturer may result in fire, electric shock or injury.
- **Children:** This appliance shall not be used by children. Take particular care when using this appliance near children. Children should be supervised to ensure they do not play with the appliance.

- **WARNING: Do not leave the product unattended when plugged in! Unplug it when you leave the room, even if it is just for a moment.**
- **Usage restriction:** This appliance is not intended for use by persons (including children) with reduced physical, sensory or mental capabilities, or lack of experience and knowledge, unless they have been given supervision or instruction concerning use of the appliance by a person responsible for their safety.
- **Before use:** Before connecting the appliance to the power supply, make sure the rotary dial is in “0” (OFF) position and the appliance is fully and correctly assembled. Failing to do so may expose you to danger and cause damage to the appliance.

**CAUTION: Do not use fingers or other objects like knives to guide food down the chute. Always use the supplied plunger.**

**CAUTION: MOVING PARTS! Keep hands, hair, clothing and utensils away from the blades and out of the processing bowl during operation to reduce the risk of injury to persons or damage to the appliance. A scraper may be used, if required, but only when the blades have completely stopped moving.**

**CAUTION! Always wait until all components have stopped running before unplugging the power cord and removing the processing bowl.**

**CAUTION: SHARP Blades and Discs! Be extremely careful when emptying the bowl, cleaning the appliance or when assembling or disassembling the appliance. The blades and discs are very sharp, handle with care!**

**WARNING! Improper assembly and misuse of the appliance can result in severe injury and damage to the product. We accept no liability for any eventual injury or damages caused by misuse of the product or noncompliance with the instructions.**

**WARNING! DO NOT USE hot liquid and food in the food processor. Allow hot liquid and food to cool down first before using it in the food processor. Hot liquid and food can eject out of the appliance due to a sudden steaming.**

**WARNING! Do not use the appliance if the rotating Disc holder (5) or the protection cover (8) is damaged or has visible cracks.**

**SAVE THESE INSTRUCTIONS  
FOR HOUSEHOLD USE ONLY**

# KNOW YOUR FOOD PROCESSOR

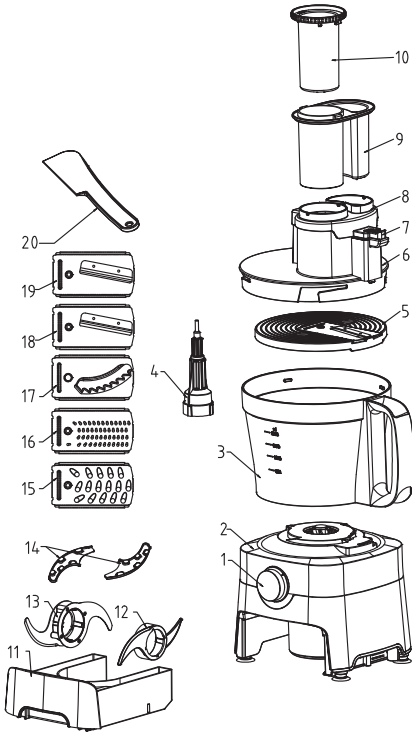

- |                         |                             |                           |
|-------------------------|-----------------------------|---------------------------|
| 1. Rotary switch        | 2. Motor base               | 3. Processing bowl        |
| 4. Driving shaft        | 5. Disc holder              | 6. Bowl lid               |
| 7. Safety lock          | 8. Protection cover         | 9. Big pusher             |
| 10. Small pusher        | 11. Blade drawer            | 12. Mixing blade          |
| 13. Chopping blade      | 14. Blade cover             | 15. Coarse shredding disc |
| 16. Fine Shredding disc | 17. French fry cutting disc | 18. Coarse Slicing disc   |
| 19. Fine Slicing disc   | 20. Spatula                 |                           |

## GETTING STARTED

Before first use

- This product has been packaged to protect it against transportation damage. Unpack it but keep all packaging materials until you have made sure your new food processor is undamaged and in good working order.
- Keep the original packaging carton and materials in a safe place. It will help prevent any damage if the product needs to be transported in the future. In the event it is to be disposed of, please recycle all packaging materials where possible.

- Plastic wrapping can be a suffocation hazard for babies and young children, so ensure all packaging materials are out of their reach. Dispose of any plastic wrapping safely.
- Read this manual to familiarize yourself with all the parts and operating principles of the food processor. Pay particular attention to the safety instructions on the previous pages.
- Unwind the power cord to its full length and inspect it for damage. Then check all parts and accessories for any damage.

**WARNING: Do not operate the appliance if there is any damage to the appliance, its cord or the accessories.**

- Clean the parts of the food processor that come into contact with food to remove any dust/residue that may have accumulated during manufacture, transport and storage.

**CAUTION!**

- Make sure the appliance is disconnected from the power supply before assembly or changing accessories.
- The blades and discs are sharp! Handle them with utmost care.
- The food processor will not operate unless the processing bowl and the chute safety lid are securely in place.
- Do not operate the appliance to process food in excess of the maximum quantities specified in the 'Instructions' section.

**IMPORTANT: OPERATING TIMES**

- **Do not operate the appliance for more than one (1) minute at a time.**
- **After one (1) minute of operation, allow the food processor to cool for at least three (3) minutes.**
- **After five (5) of these operating cycles, allow the unit to cool to room temperature.**

**NOTE: Failing to follow the above instructions may cause damage to the product.**

Assembling the processing bowl

- Place the motor base on a flat, sturdy and dry work surface, where the non-slip feet will keep it steady during food processing.
- Position the processing bowl onto the motor base, aligning the arrow on the bowl base with the 'open lock' symbol on the motor base (Fig. 1).
- Holding the bowl by the handle, firmly turn it in clockwise direction towards the 'closed lock' symbol on the motor base until it is securely locked in place (Fig. 2).
- Place the drive shaft vertically onto the rotor inside the bowl (Fig. 3).
- The blade storage drawer contains all blades and discs for use with the food processor (Fig. 4). Open the drawer and take out the disc appropriate for your food processing task. Only one blade can be used at any one time!

**CAUTION: The blades and discs are sharp, handle with care!**

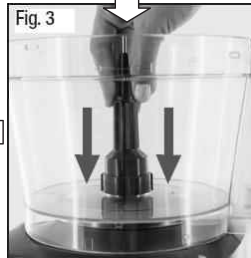

### Attaching the chopping or mixing blade

- The stainless steel chopping blade and the plastic mixing blade are installed at the bottom of the processing bowl. This set up allows you to chop and mix a variety of foods such as ingredients for a dip or salsa, or cheese, onions, garlic, herbs, vegetables, meat, nuts, and so on.
- The blades of the stainless steel chopping blade are covered with protective plastic sleeves, which must be removed before using the chopping blade (Fig. 5).  
**CAUTION: The blades are sharp! Handle with care.**
- The mixing blade (Fig. 6) is made of food grade plastic, which is suitable for thorough mixing of dough ingredients.
- To use the chopping or mixing blade, place the blade on the drive shaft, making sure the four small notches are facing upwards (Fig. 7). Correctly inserted, the lowest part of the blade should be less than a centimeter from the bottom of the bowl.

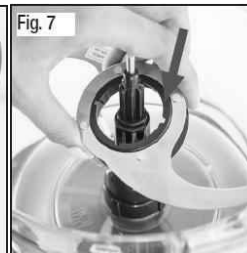
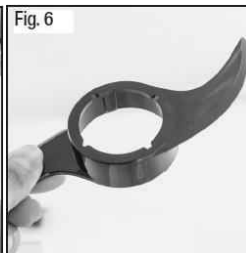

### Attaching a food processing disc

- The food processor comes with a disc holder and 5 stainless steel discs for slicing food (thin and

thick), shredding food (fine and coarse) and cutting French fries. See page 9 for a picture of all accessories supplied. Only one blade can be used at any one time!

- With the appropriate disc attached to the disc holder, the system is ideal for slicing or shredding food such as potatoes, cucumbers, onions, carrots, cabbage, zucchini, or any other food you want evenly sliced or shredded. There is even a disc for cutting potatoes into French fries.
- To use one of these slicing/shredding discs, slide the side of the disc marked with an arrow into the grooves on the disc holder (refer to Fig. 8). It should click securely into place.

**CAUTION: The blades are sharp! Handle with care.**

- With the disc installed, hold the disc holder by the cut outs and place it on top of the drive shaft and push down gently (refer to Fig. 9).

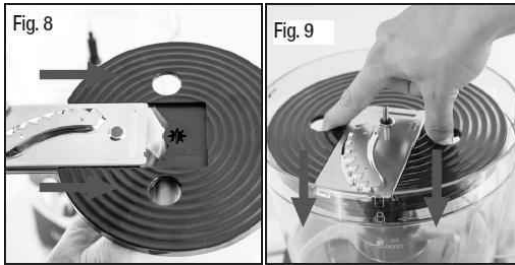

### Attaching the lid

- Place the lid on top of the bowl, making sure that the rectangular marking on the lid is aligned with the 'open lock' symbol at the top of the processing bowl (refer to Fig. 10).
- Firmly turn the lid in clockwise direction towards the 'closed lock' symbol until it securely locks into place. The chute safety lid lock should be aligned with the handle of the processing bowl (Fig. 11).
- Pull out the latch of the chute safety lid lock, press down the lid and release the latch to lock the lid (Fig. 12).
- Make sure the rotary dial is set to "0" position, then insert the power plug into an appropriate electrical mains power outlet.
- To check that the food processor is properly assembled, turn the rotary dial briefly in anticlockwise direction to the Pulse "P" setting. If it does not pulse, or you notice anything unusual, unplug the appliance and reassemble it, following all relevant steps on the previous pages.

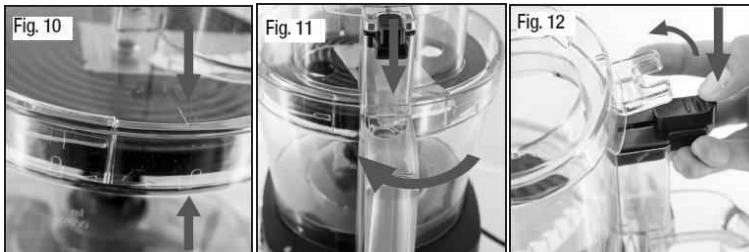

## Using the plunger

- The food processor comes with 2 plungers: the large (double), clear plunger fits the small (round), black plunger inside (Fig. 13).
- The large (double) plunger is recommended for processing larger ingredients. To use it, insert the small plunger into the round opening of the large plunger and turn it clockwise to lock.
- Open the chute safety lid and place larger ingredients into the chute, then lock the chute safety lid again.
- Use the large plunger to gently press the food pieces into the rotating blade (Fig. 14).
- The small (round) plunger is recommended for processing smaller ingredients. To use it, unlock it from the large (double) plunger by rotating it anticlockwise, then remove it from the large plunger.
- Insert the large (double) plunger into the chute (Fig 14.), place smaller food pieces into the round opening of the large plunger, then use the small plunger to gently press the food pieces into the rotating blade (Fig. 15).
- **IMPORTANT!** Do not force ingredients into the feed chute. If the food pieces are too large, cut them to size before processing.

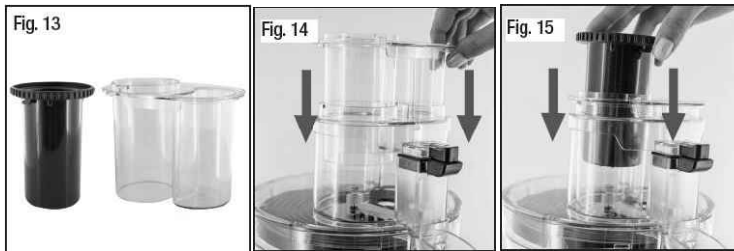

## Chopping blade (13)

**Standard processing time is 30 seconds to 1 minute.** Please refer to the following table for the max. volume per batch:

Ingredient	Volume
Chocolate	≤200g
Cheese	≤350g
Meat	≤800g
Vegetable & Spice	100-150g
Fruit	300-500g
Onion	≤800g



## Mixing blade (12)

**Standard processing time is 20 to 30 seconds.** Please refer to the following table for the max. volume per batch:

Ingredient	Volume
Flour & soft cheese	≤800g
Egg	≤10pcs

Tips and warnings:

The ratio of flour to water to make dough is 1: 0.6, meaning 100g flour needs 60g water to make best effect. The standard of processing time should be within 30 sec., as the flour will become sticky and will stick to the driving shaft if the time lasts too long. It will make the machine shake, and work abnormally.

## Disc for fine slicing/coarse slicing/ coarse shredding/ fine shredding

Choose the blade disc according to ingredients and the size you want. Put the blade disc you choose into the plastic disc holder (5), then seat it in the driving shaft (4). Close the processing bowl cover, and lock the feed chute cover using the safety lock (7) on the lid. You can start to process the food when the machine operates. If the food size is small, put the big pusher (9) onto the feed chute cover, and use the small pusher (10) for convenient operation.

DO NOT put lot of force when pushing the ingredients into the feed chute using the pusher. It is better to chop large size ingredients into smaller ones to fit the feed chute size.

Lower speed is recommended while slicing soft ingredient to prevent it from becoming pasty. For processing large amounts of ingredients, divide them into several batches for processing. The standard processing time is 1 minute.

## **French Fry cutting disc**

Set the French fry cutting disc (17) similar to the way of setting the shredding blade. Start the appliance to ensure it is working normally. Then turn the switch off to stop the machine, and prepare for food processing. The French fry cutting disc is only for coarse cutting. It can only process soft vegetables, such as potato.

For French fry cutting, open the feed chute over, put the food in, close the cover, and then use the big pusher with the small pusher locked on it for operation.

## **WARNING**

- Be extremely careful when handling blades and inserts, especially while assembling and disassembling, and cleaning after use. The blades are very sharp.
- Clean the chopper and keep it in the blade cover. Make sure that the blade is not exposed, in order to avoid cutting yourself for use next time.

- The spatula is for scraping and cleaning the processing bowl after the machine stops operating. **Do not put the spatula into the feeding chute to stir the food while the machine is operating, as it could be dangerous.**

## **TROUBLESHOOTING**

<b>Problem</b>	<b>Solution</b>
Machine does not work.	Ensure correct assembly. Make sure power plug is plugged in properly. Check if the mains have tripped, or if there is a power outage.
Machine stops running suddenly.	Processing bowl may loosen during vigorous processing. Please re-install the bowl cover.
Motor is operating, but accessories do not move.	Make sure the accessories are installed correctly.

## **CLEANING**

1. Disconnect from mains power before cleaning.
2. Empty the processing bowl and remove the disk holder from the bowl. Then remove the shredding/cutting/slicing blade from the disk holder, the pusher from the lid, and the lid from the bowl. Immerse the lid, pusher, processing bowl, disk holder and the shredding/cutting /slicing blade in warm water and clean them with a soft brush. Do not use any of the parts in a dishwasher.

**CAUTION: The blade is extremely sharp. Handle with care.**

3. Wipe the outside of the motor base with a cloth. Never immerse it in water as electric shock is possible to occur. Then dry thoroughly. Ensure the interlock area is free of food particles

**Note:** Some food may discolor the processing bowl. This is normal and will not harm the plastic or affect the flavor of food. Rub with cloth dipped with vegetable oil to remove discoloration

## **TECHNICAL SPECIFICATION**

Voltage: 220-240V~ 50/60Hz

Power: 700W

Processing Bowl Max. Capacity: 2.0L

## **12 Month Warranty**

Thank you for your purchase from Kmart.

Kmart Australia Ltd warrants your new product to be free from defects in materials and workmanship for the period stated above, from the date of purchase, provided that the product is used in accordance with accompanying recommendations or instructions where provided. This warranty is in addition to your rights under the Australian Consumer Law.

Kmart will provide you with your choice of a refund, repair or exchange (where possible) for this product if it becomes defective within the warranty period. Kmart will bear the reasonable expense of claiming the warranty. This warranty will no longer apply where the defect is a result of alteration, accident, misuse, abuse or neglect.

Please retain your receipt as proof of purchase and contact our Customer Service Centre on 1800 124 125 (Australia) or 0800 945 995 (New Zealand) or alternatively, via Customer Help at [Kmart.com.au](http://Kmart.com.au) for any difficulties with your product. Warranty claims and claims for expense incurred in returning this product can be addressed to our Customer Service Centre at 690 Springvale Rd, Mulgrave Vic 3170.

Our goods come with guarantees that cannot be excluded under the Australian Consumer Law. You are entitled to a replacement or refund for a major failure and compensation for any other reasonably foreseeable loss or damage. You are also entitled to have the goods repaired or replaced if the goods fail to be of acceptable quality and the failure does not amount to a major failure.

For New Zealand customers, this warranty is in addition to statutory rights observed under New Zealand legislation.

