

KMART

INSTRUCTION MANUAL

BICYCLE ASSEMBLY & MAINTENANCE

42547228 20" (50cm) RHYTHM 00 BMX BICYCLE

IMPORTANT NOTICE! Do Not Return This Product To The Store. Please Keep Your Instructions! Your Model Number is necessary should you need to contact us. Please read through this instruction manual book to familiarize yourself with all parts and assembly steps. Kindly refer to the parts identifier below and be sure that all parts

have been included. Although we are dedicated to giving our customers the best product possible, a question may arise or parts may be missing. If you are missing parts or if you have any questions, Please contact our fast and friendly service centre on:TEL 1800-124-125

TABLE OF CONTENTS

RULES OF THE ROAD	1
OWNER'S INFORMATION	1
OWNER'S IDENTIFICATION RECORD	2
SAFETY WARNINGS	3
SAFE SIZING OF A BICYCLE	4
TOOLS REQUIRED FOR ASSEMBLY	4
ASSEMBLING YOUR BIKE	5
FRONT WHEEL	5
KICKSTAND	5
HANDLEBAR STEM	6
HANDLEBAR	6
SEAT POST AND SEAT	7
BRAKE ADJUSTMENT	8
REFLECTORS	13
PEDALS	14
WHAT IS TORQUE?	16
TORQUE REQUIREMENTS	16
MAINTENANCE	17
SAFETY CHECK LIST	21
THE RULES OF SAFE CYCLING	22
WARRANTY STATEMENT	23

**IT IS IMPORTANT TO READ THIS MANUAL THOROUGHLY
BEFORE ASSEMBLING, RIDING, OR PERFORMING
MAINTENANCE ON THIS BICYCLE.
KEEP THIS MANUAL FOR FUTURE REFERENCE.**

RULES OF THE ROAD

1. **IN THE INTEREST OF SAFER CYCLING, MAKE SURE YOU READ AND UNDERSTAND YOUR OWNER'S MANUAL.**
2. **NOTICE:** Some state and local traffic laws may require that your bicycle be equipped with a warning device, such as a horn or bell and a light, if the bicycle is to be ridden after dark.
3. Always ensure that appropriate footwear is worn whilst riding this bike. Lace up shoes with rubber soles, never ride barefooted or in sandals, and ensure that shoelaces are tied and kept out of the way of the wheels and drive system.
4. **CAUTION: WET WEATHER WARNING:** Check your brakes frequently. The ability to stop your bicycle is critical. Roads are slippery in wet weather so avoid sharp turns and allow more distance for stopping. Caliper brakes may become less efficient when wet. Leaves, loose gravel and other debris on the road can also effect stopping distance.
5. The kickstand is designed to support the bicycle only. Not the rider.
6. Replace bent or broken spokes, and bent or damaged wheel rims.
7. Obey all traffic regulations. Most traffic regulations apply to bike riders as well as automobile operators.
8. Follow the traffic flow in a straight line close to the curb. Watch for cars moving in and out of traffic.
9. Always ride alone. Never carry other riders. This is dangerous and it makes the bicycle harder to control.
10. When riding in pairs or in larger groups, form a single line along the left side of road. Set up a sensible distance between riders. Don't tailgate.
11. Always be alert. Animals or people may dart in front of you. Be on the alert. People have the right of way. Be alert to people opening car doors when passing parked cars. Your bicycle was not designed for stunting and experimentation. Enjoy riding it in a safe manner.
12. Be careful at all intersections. Slow down and look both ways before crossing.
13. Use hand signals. Always let other drivers and pedestrians know what you are going to do. Signal 100 ft(30.48 cm). before turning unless your hand is needed to control the bike.
14. **CAUTION: NIGHT TIME OPERATION:** We do NOT recommend riding your bike at night. If you have an emergency that makes it necessary to ride at night, have proper lights and reflectors. Do NOT ride at night without a headlight, taillight, a white front reflector, a red rear reflector and yellow wheel reflectors.
15. Do not carry packages or objects which obstruct vision.
16. Never hitch rides. Never hold onto moving vehicles while riding. Never Stunt.
17. **ON AND OFF ROAD OPERATION:** Avoid the following hazards: drain grates, pot holes, ruts, soft road edges, gravel, and leaves especially when they are wet.

OWNER'S INFORMATION

Throughout this manual you will find **WARNINGS, CAUTIONS and NOTES or NOTICES.**

WARNINGS: Pay special attention to these since failure to do so could result in injury to the rider or others.

CAUTIONS: If not followed these could result in mechanical failure or damage.

NOTES OR NOTICES: These specify something that is of special interest.

Owner's information continued next page.

OWNER'S INFORMATION continued

It is the responsibility of the person who initially assembles the bicycle to do so correctly and make any necessary adjustments for proper operations. The owner or principal rider is then responsible for normal maintenance of the bicycle to keep it in good condition.

1. Make certain that all assembly instructions and necessary adjustments have been followed.
2. Perform the safety check list and mark each item listed.
3. Know how to operate all standard and accessory equipment on the bicycle.
4. Make certain that anyone who uses the bicycle has been fully instructed in its operation.
5. If your bicycle was obtained assembled, we recommend that you review the complete assembly instructions and perform checks specified in this manual before riding the bicycle.

OWNER'S RECORD

Keep this information as a permanent record

In the event of theft or loss, your law enforcement agency will require this information for identification purposes.

The same information will be required when ordering parts and service.

Serial number(if you have one): _____

Wheel Size (On tire sidewall): _____

Model Number: _____

Color of bike: _____

Name of bike (On top tube or chain guard): _____

Date purchased: _____

Where Purchased: _____

WARNING:

ALWAYS WEAR A HELMET

DO NOT RIDE AT NIGHT

SAFETY WARNINGS

Before you ride, please read all the following items making sure you understand them. Failure to do so could cause damage to the bicycle or possible injury to yourself or others. Your bicycle meets or exceeds industry standards. It is NOT designed for off-road use. Jumping, stunts and other types of abusive riding.

BRAKE PRECAUTIONS

1. Do not ride the bicycle until you have checked for proper brake adjustments See “Hand brake lever Assembly” and “Caliper Brake Adjustment” Sections.
2. When riding your bicycle for the first time. Test the brakes at a slow speed on a large level surface without obstructions. Also never attempt to stop suddenly using the front brake only, as this could throw the rider off the front of the bicycle.
3. Check and adjust the brakes, if necessary, at the first sign of failure, This will enable the rider to make a quick and smooth stop. On caliper brakes, if a brake lever touches the grip when it is squeezed. Adjust the brakes.
4. Going downhill fast is dangerous since you can't stop nearly as fast as you can on level ground. A curve at the bottom of a hill could force you into oncoming traffic or off the road if you are going at an excessive speed.
5. Use the front brake slowly and carefully, especially while turning or when the road is wet or covered with gravel, sand or leaves. Start braking sooner under these conditions and with less force to reduce the chances of skidding. Wet brake shoes mean that it will require more distance to stop. Start braking sooner than normal in wet conditions.
6. Night time riding:
 - a. You can't see the controls on your bicycle at night so you must know where they are by touch.
 - b. Slow down. Debris and holes are much harder to see at night.
 - c. If possible, ride on streets that are familiar to you. Terrain that you have never seen during the day is dangerous at night.
 - d. Use well lighted streets whenever possible. Avoid unlighted bike paths.
 - e. Comply with all legal requirements in your state. You should at least have a “ white light” (not just a white reflector) on the front and a rear red reflector. All states require that a lamp be used that emits a white light.
 - f. Children should not be allowed to ride a bicycle at night or during periods of low visibility such as dawn, dusk or bad weather. Adults should avoid night riding if possible.
 - g. It is a good idea day or night to wear a helmet and have a rear view mirror.
7. If the stem is not inserted into the head tube to at least the minimum insertion line, it is possible to over-tighten the handlebar stem bolt and damage the fork stem body. This could cause an unsafe condition and risk injury to the rider.
8. For safe operations, you must secure the pedal spindle tightly against the crank arm with a wrench that fits the shoulder of the pedal spindle. This is important: It avoids stripping threads. Always replace damaged pedals.
9. When adjusting the seat height, you must have the minimum insertion mark on the seat post inserted inside the frame.

SAFE SIZING OF A BICYCLE

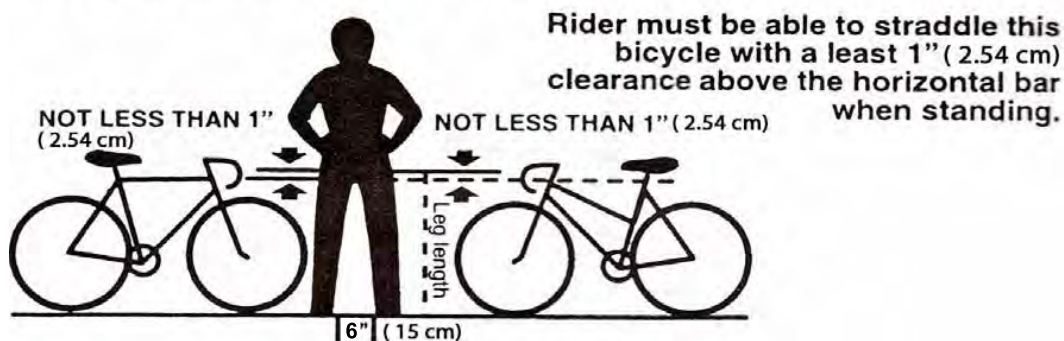

The correct frame size is the largest frame that the rider can automatically straddle keeping both feet on the ground and allowing 25 mm (1 inch) clearance between the rider's crotch and the top of the frame tube (see illustration) Noted Ladies can use men's bicycle to determine their correct frame size.

Rider must be able to straddle bicycle with at least 1 inch (2.54cm) clearance above the horizontal bar when standing.

UNPACKING

Important: Remove the bicycle and all parts from the carton. Lay out all unassembled parts and **READ THE ASSEMBLY INSTRUCTIONS** In this manual before assembling our bicycle. The instructions are a step by step procedure. Follow the steps that pertain to your model.

NOTE: Your bicycle may be equipped with a different component than the one illustrated. However, the procedure for assembly or adjustment is basically the same.

RECORD SERIAL NUMBER

Note: This information is only available on the bicycle itself. Be sure to keep your own record of this number. Each bicycle has a serial number stamped into the bottom of the frame or on the head tube. (See illustration) Record this number on page 2 of your owner's manual to keep it for future reference.

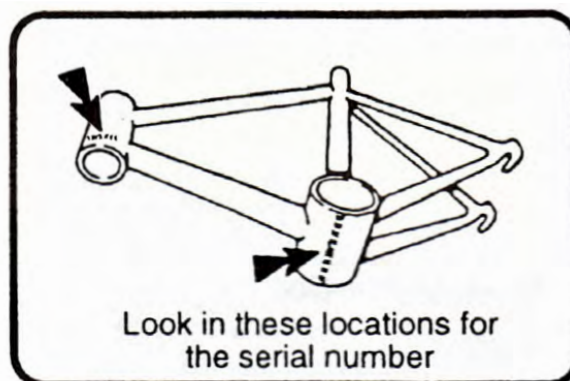

TOOLS REQUIRED FOR ASSEMBLY

7mm Phillips screw driver

7mm flat edge screw driver

Standard slip joint pliers

hammer Torque Wrench Set

2 in 1 of 5mm & 6mm Allen wrenches and open end set of metric flat wrenches 6" (15 cm) and 10" (25.4 cm) Adjustable wrench (Or Open End Set Of Metric Flat Wrenches). These tools should be available to perform the basic steps of assembling the bicycles. They can also be used to make maintenance adjustments outlined in this manual. Special tools are required to disassemble chain, remove the rear hub parts and true wheels. Special tools are not required for assembly and normal maintenance.

NOTE: Use a hand or foot pump to Inflate tires. Never inflate tire with an air compressor at a gas station. **WARNING: IMPROPER INFLATION IS THE BIGGEST CAUSE OF TIRE FAILURE. DUE TO THE SLIGHTLY POROUS NATURE OF BICYCLE INNER TUBES, IT IS NORMAL FOR YOUR TYRES TO LOSE PRESSURE OVER TIME. FOR THIS REASON, IT IS CRITICALLY IMPORTANT TO MAINTAIN THE PROPER TIRE INFLATION ON YOUR BIKE.**

Many bicycles are sold unassembled in cartons. For these bikes it is the responsibility of the owner to make sure the assembly instructions in this book are followed exactly. For bicycles that are purchased in an assembled condition, it is the responsibility of the owner to carefully check and test the bike. The bicycle product does not provide above tools.

START TO ASSEMBLE YOUR BICYCLE

STEP#1 – REMOVE BIKE FROM CARTON

Be sure all parts are removed from carton, Check before you discard the carton.
Remove all protective packing material.

STEP#2- ASSEMBLE THE FRONT WHEEL TO FORK

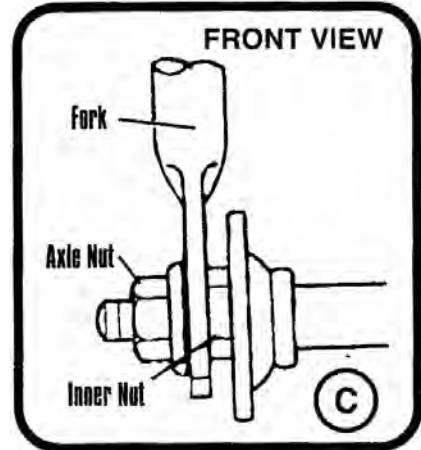
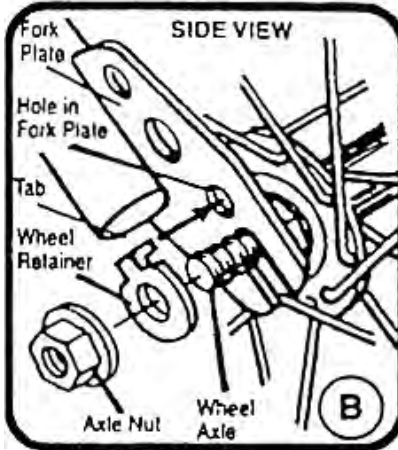
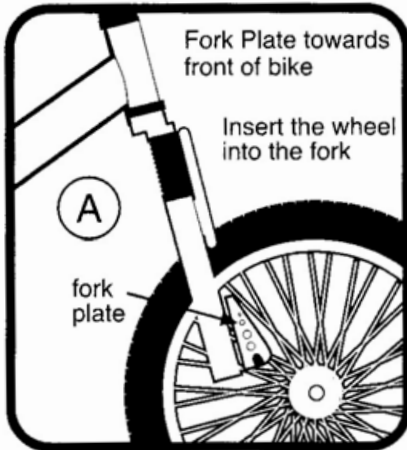

1. Turn the fork until the fork plate points to the front of the bicycle.(See illustration A)
2. Insert the wheel into the fork.
3. Install a wheel retainer and an axle nut to each side of the axle. Make sure the tab of each wheel retainer fits into the hole at the end of each fork plate.(See illustration B)
4. Tighten the axle nuts by hand. Make sure there is an equal distance between each fork tube and the wheel. Then use a wrench and securely tighten the axle nuts. (See illustration C&D)

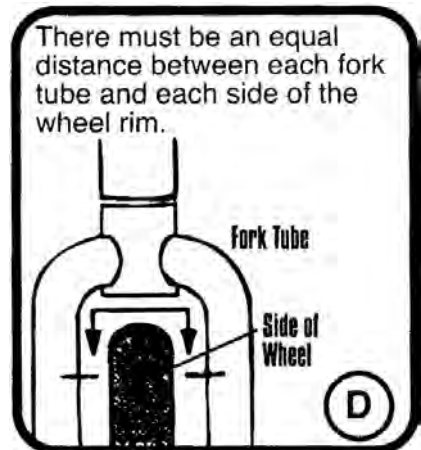

TORQUE REQUIREMENTS (SEE PAGE 16)

STEP#3 – KICKSTAND ASSEMBLY Not Every bike comes with kickstand

NOTE: YOUR KICKSTAND MAY BE PREASSEMBLED AT THE FACTORY. IF SO, PLEASE PROCEED TO STEP 4.

1. Place the bicycle in an upright position.
2. Remove the top plate from the kickstand.
3. From the left side of the bicycle(opposite side from chainguard). Place the kickstand in position beneath the two rear fork legs.
4. Place the top plate, flange down, onto the mounting bolt.
5. Replace the washer and nut onto the mounting bolt. Hold the kickstand arm in an up position aligned with the frame stay, Then securely tighten the mounting bolt.
6. Leave leg of kickstand down so it will support the bicycle during the rest of the assembly.

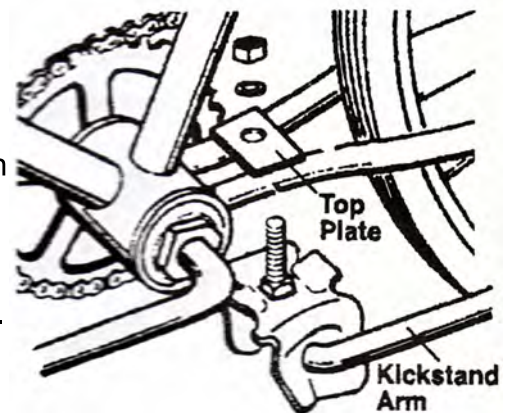

WARNING: THE KICKSTAND IS DESIGNED TO SUPPORT THE BICYCLE ONLY, NOT THE BICYCLE AND THE RIDER.

HANDLE BAR/STEM

STEP #4 – A-HEAD STEM ASSEMBLY

Note: Your stem has been pre-assembled to the fork at our factory.

1. Insert the stem pillar into the fork tube to the minimum insertion line, indicated on the stem pillar
2. Tighten the 6mm stem pillar bolt to a torque requirement of 12-15 ft.lb(16-20N.m).
WARNING: The handlebar stem pillar must be inserted into the head tube until the minimum insertion line indicated on the stem is covered.

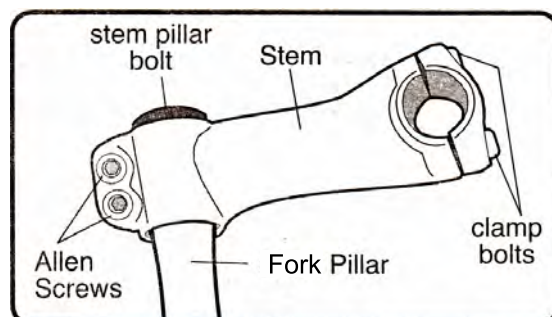

3. Loosen the two 5mm Allen screws on the handlebar stem and slide onto the stem pillar. Align the top of the handlebar stem with the top of the stem pillar (not the stem cap). Face the handlebar stem forward directly in line with the front wheel.
4. Tighten the two 5mm Allen screws on the handlebar stem to 7 ft.lb(9N.m).
WARNING: THE ASSEMBLER IS CAUTIONED AGAINST THE DANGER OF DAMAGING THE HANDLEBAR STEM PILLAR ASSEMBLY AND POSSIBLE INJURY TO RIDER IN OVERTIGHTENING THE STEM PILLAR BOLT.
5. Angle and tighten the bolt securely (Recommended torque is 20 ft lbs) Check the stem for tightness before riding. **WARNING: DO NOT TRY TO ADJUST THE SCREWS ON THE SIDES OF THE STEM EXTENSION. WARNING: THE ASSEMBLER IS CAUTIONED AGAINST THE DANGER OF DAMAGING THE HANDLEBAR STEM ASSEMBLY AND POSSIBLE INJURY TO RIDER IN OVERTIGHTENING THE EXPANDER BOLT AND EXPANDER WEDGE.**

STEP #5 – ASSEMBLY THE HANDLEBAR

WARNING: FOR SAFE OPERATION, THE EXPANDER BOLT AND CLAMP BOLT MUST BE SECURELY TIGHTENED.

1. Loosen clamp bolt with an Allen wrench.
2. Adjust handlebar to desired angle.
3. Securely tighten clamp bolt.(recommended torque is 15 ft.lbs(20N.m))
4. Check handlebar for tightness. If you can move it forward or backward, the clamp bolt is not tight enough.
5. Check steering by straddling the front wheel and trying to turn the handlebar. If you can turn the handlebar without turning the front wheel. The stem is too loose. Align the handlebar with the front wheel. Re-tighten the expander bolt (clockwise).

STEM #6 – INSTALL SEAT POST AND SEAT

FOR YOUR CONVENIENCE THE SEAT MAY HAVE BEEN ASSEMBLED TO THE SEAT POST AT THE FACTORY.

1. Loosen seat clamp nuts.
2. Insert the top portion of seat post into the seat clamp. Be sure the seat post is completely inserted into the seat clamp and butted tight against the end stop.
3. Re-tighten seat clamp nuts on both sides. (Hand tight) these nuts will be tightened later with an adjustable wrench.
4. Insert seat post into bicycle frame, Be sure that seat post is inserted into frame at least 2 1/2" (65mm).

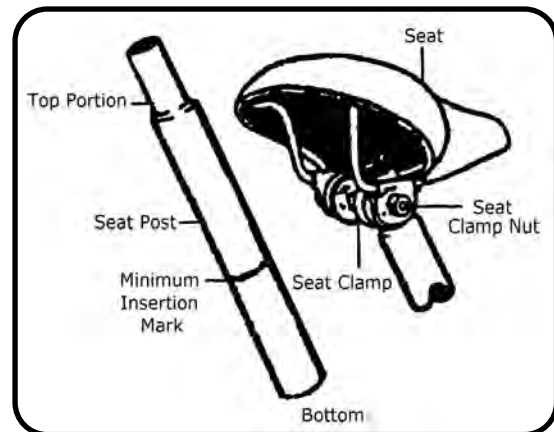

CAUTION: MINIMUM INSERTION LINE SHOULD BE COMPLETELY INSERTED INTO THE FRAME AND NOT VISIBLE.

Seat post and seat assembly continued on next page.

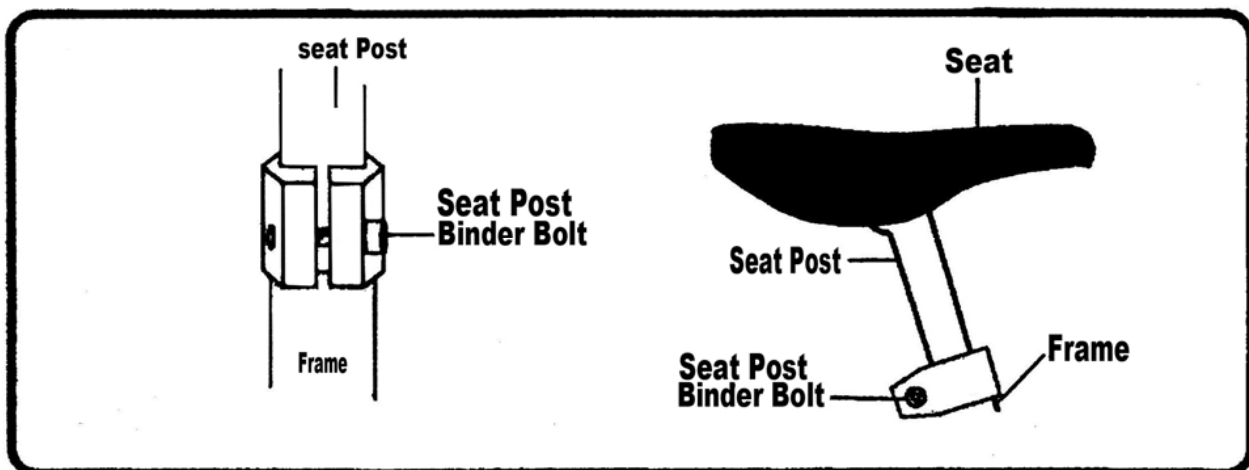

5. Tighten seat post binder bolt securely at desired height.
6. Adjust angle of seat so that top of seat is parallel to the ground or comfortable to the rider.
7. Retighten seat clamp nuts securely with an adjustable wrench.

PLEASE NOTE: Test the seat to pedal distance by having the rider sit on the seat. When the rider's leg is slightly bent the ball of the foot should rest on the pedal when it is in its lowest position. If it does not, adjust the seat height as necessary.

Check for tightness by attempting to twist the seat. If the seat is loose, be sure to tighten the binder bolt securely.

TORQUE REQUIREMENTS(SEE PAGE 16)

IF YOUR BICYCLE HAS A QUICK RELEASE SEAT POST, SEE QUICK RELEASE INSTRUCTIONS.

STEP#6 – SEAT POST AND SEAT continued.

IF YOUR BICYCLE HAS A QUICK RELEASE SEAT POST:

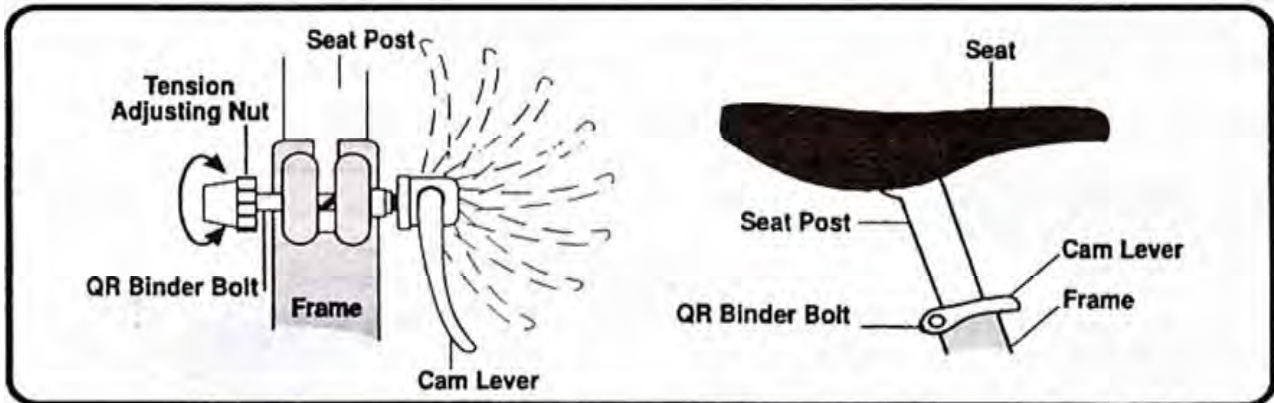

5. Tighten the quick release seat post binder bolt securely at desired height. Turning the tension adjusting nut clockwise while keeping the cam lever from rotating increases clamping force: turning it counterclockwise while keeping the cam lever from rotating reduces clamping force. Less than half a turn of the tension adjusting nut can make the difference between safe clamping force and unsafe clamping force.

6. Adjust angle of seat so that top of seat is parallel to the ground or comfortable to the rider.

7. Retighten seat clamp nuts securely with an adjustable wrench.

PLEASE NOTE: Test the seat to pedal distance by having your child sit on the seat. When your child's leg is slightly bent the ball of the foot should rest on the pedal when it is in its lowest position. If it does not, adjust the seat height as necessary.

Check for tightness by attempting to twist the seat. If the seat is loose, be sure to tighten the clamp nut and binder bolt nut securely.

TORQUE REQUIREMENTS(SEE PAGE 16)

STEP #7 – IF YOUR BIKE HAS A FRONT OR REAR HAND BRAKE FOLLOW THESE INSTRUCTIONS FOR ADJUSTMENT.

WARNING: The handbrakes on this bicycle were Not adjusted at the factory. Before you ride this bicycle you must assemble and adjust the hand brakes. The brake levers are pre-assembled. The right side of the handlebar for the front brake and the left side of the handlebar for the rear brake.

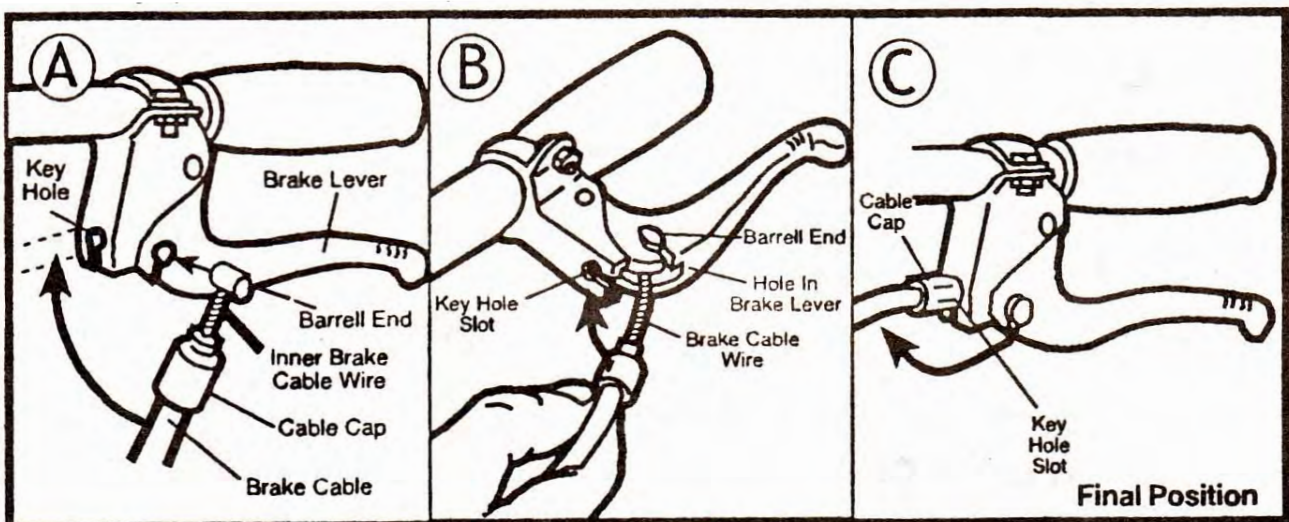

1. Insert the barrel end of the brake cable into the hole in the brake lever.(See illustration A) Squeeze the rear brake arms with your hand until the brake rubbers are up against the wheel rim. This will enable the inner brake cable wire to be loose, and have enough space for you to easily slip the barrel end of the brake cable wire into the hole in the brake lever.
2. Next, pull the brake cable wire through the key hole slot in the front of the brake lever(See illustration B) and then remove your hand. The brake cable cap will automatically spring back into the slotted key hole on the front of the brake lever assembly.(See illustration C)
3. Next, proceed to adjust the hand brake.
 - (a) Loosen the anchor bolt nut. (See illustration D)
 - (b) Again squeeze the rear brake rubbers against the wheel rim.
 - (c) Pull the brake cable wire through the anchor bolt hole.(See illustration D)until there is no slack in the inner brake wire.
 - (d) Tighten the anchor bolt nut (**SEE TORQUE REQUIREMENTS – PAGE 16**)
 - (e) Squeeze the brake lever hard and then release several times. Rotate the rear wheel, be sure the rear wheel is straight and does not wobble. The brake rubbers should not touch the wheel rim, and there should be about 1/16 inch(1.6cm) Clearance between the wheel rim and each brake rubber.(See illustration E).

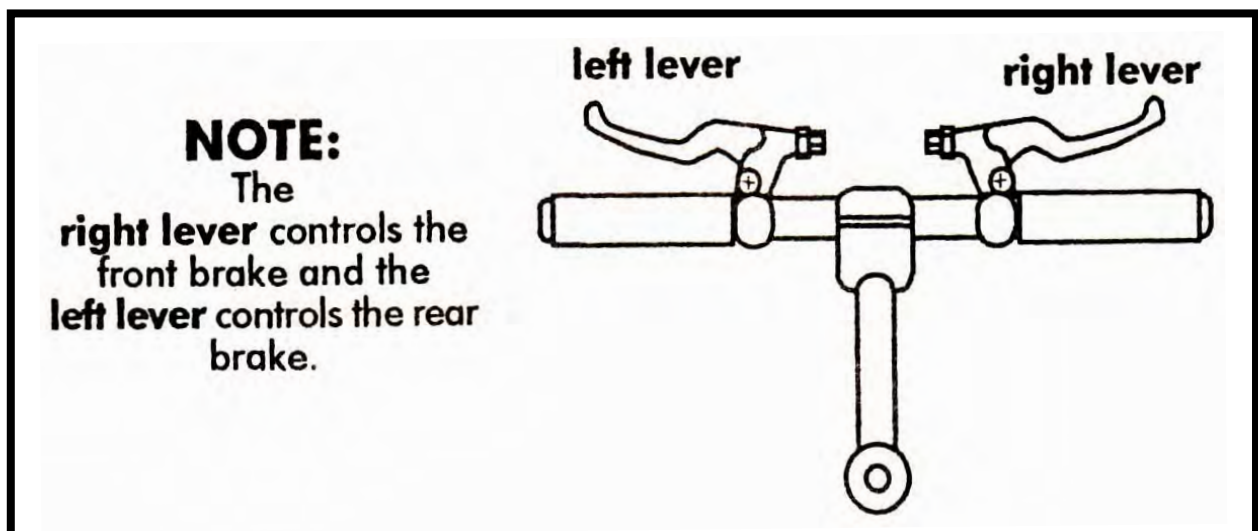

IF THE BRAKE RUBBERS TOUCH THE WHEEL RIM

Loosen the anchor bolt nut and let the brake rubbers spring open a little, to clear the wheel rim. Re-tighten the anchor bolt nut and squeeze and release the brake lever. Check the clearance again. Repeat the adjustment if necessary.

NOTE: If additional brake adjusting is required – you can bring the brake rubbers closer to the wheel rim by turning the adjusting screw counterclockwise. To move the brake rubbers further from the rim, turn the adjusting screw clockwise. Be sure the cable is locked securely through the anchor bolt. (See illustration D). Reset cable adjuster lock nut when adjustment is final.

WARNING: If after brake adjustments are made, and the hand brake still does not function, then have brake repaired or adjusted at a bicycle service shop. Do not ride if brakes do not function properly.

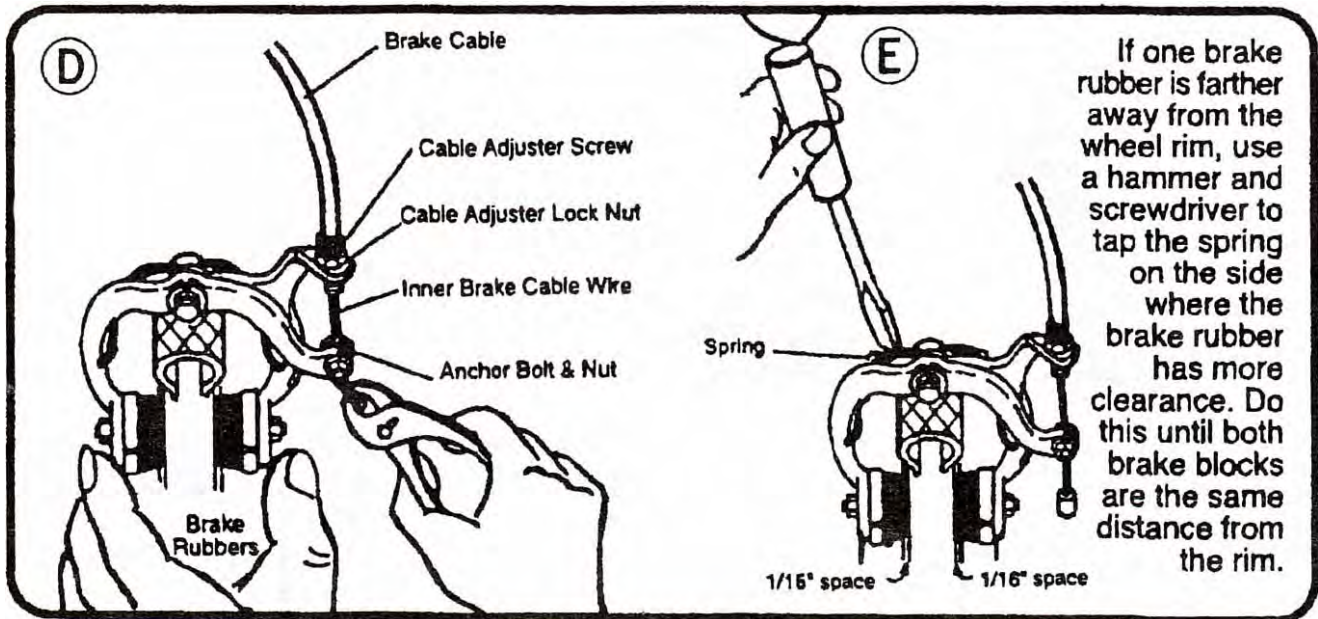

REAR U-BRAKE ASSEMBLY

WARNING: YOU MUST ASSEMBLE AND ADJUST THE REAR U-BRAKE BEFORE RIDING THIS BIKE.

1. Adjust the brake lever so the distance from the grip is comfortable for the rider. You can do this by turning the adjustment screw to change the distance.

Make sure the back of each grip is no more than 3 1/2" from the front of each brake lever

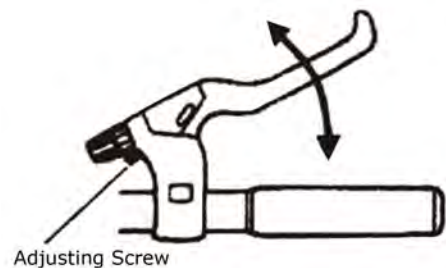

U-BRAKE ASSEMBLY/ ADJUSTMENT Continued

Put the brake shoes in the correct position for braking.

- A. Loosen the nut on each brake shoe.
- B. Align each brake shoe so that it is no more than 1/16" from the wheel rim sides.
- C. Make sure the rubbing surface of the brake shoe is flat against the wheel rim.



- D. Make sure the brake shoe does not touch the tire.
- E. When the brake shoes are aligned correctly, tighten the nut on each brake shoe.

Test the tightness of each brake shoe. Try to move each one out of position, if it moves, repeat the steps above until the brake shoes are secure.

Assemble the crossover cable to the rear caliper brake arm

- A. Loosen the nut on the cable clamp.
- B. Slide the cable through the brake noodle.
- C. Hook the cable nob into the brake slot of the caliper arm.
- D. Have a second person squeeze the caliper brake arms together, holding the brake shoes against the rim.
- E. Use pliers to pull the crossover cable as tight as possible. While continuing to hold the brake arms and crossover cable in this position, tighten the cable clamp.
- F. If available, crimp a small metal cap onto the ends of the crossover cable and cable wire. This will keep the wire from fraying.

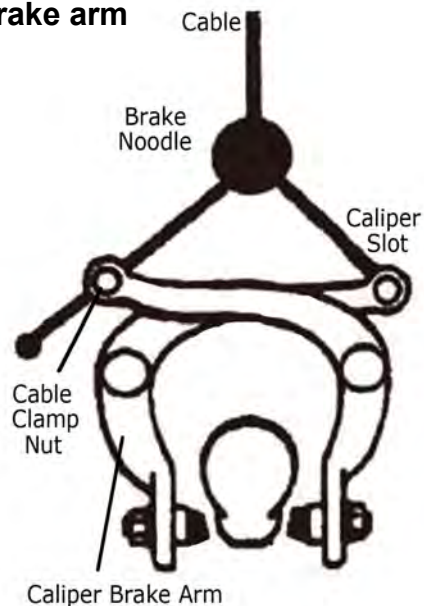

Test the tightness of the cable carrier and clamp by squeezing the brake lever firmly. The crossover cable should not move in the cable clamp. If the crossover cable does move, repeat steps D, E and F above. Repeat until secure.

If the cable wire moves in the cable carrier, loosen the nut on the carrier, have a second person squeeze the brake arms against the rim, pull the cable wire tight and push the cable carrier up the cable wire as far as possible. Hold the cable wire, cable carrier and brakes arms in this position and tighten the nut on the cable carrier. Repeat these steps until secure.

CAUTION: Please check the brake pads and cables for proper alignment, tightness and wear regularly. Do not operate this bicycle if the brakes are not functioning properly. If you cannot get the brakes to function properly, it is recommended that you take the bike to a qualified bicycle repairman. Replace the brake shoes when the rubber pad wears to within 1/8" from the metal base.

Both brake shoes should be the same distance from the wheel rim.

To adjust the distance, turn the spring adjustment screw on the brake arms until both brake shoes of each brake are the same distance from the rim. If your brakes do not have a spring adjustment screw, they may have a hex-shape or other mechanism around or near the spring of each brake arm.

Put the brake shoes in the correct position.

To adjust the position of the brake shoes, loosen the locknut on the brake lever. Turn the adjusting barrel clockwise to put the brake shoes 1/16" from the wheel rim.

Make sure the brake shoes do not rub on the wheel rim when the brakes are not engaged. If rubbing occurs, move the brake shoes away from the rim until correct.

WARNING: If your wheel rim is not true, this can cause the brakes to be less effective and unsafe. Have a qualified bicycle repairman true your bicycle wheels.

Tighten the locknut on the brake lever.

Have someone hold the brake shoes against the wheel rim.

Loosen the cable carrier. If you can not turn the adjusting barrel counterclockwise far enough to put the brake shoes in the correct position, remove the slack from the cable wire.

Remove the slack from the cable wire.

Loosen the locknut and turn it counterclockwise until it is against the adjusting barrel. Turn the adjusting barrel fully into the brake lever or the u-brake. Have a second person Squeeze the brake arms, so that the brake shoes are against the rim.

Pull the cable wire tight and push the cable carrier up the cable wire as far as possible. Hold the cable wire and the carrier in this position and tighten the nut on the cable carrier. Use the adjusting barrel to put the brake shoes in the correct position.

Test the tightness of the cable carrier and clamp by squeezing the brake lever firmly. The crossover cable should not move in the cable clamp. If the crossover cable does move, repeat steps above. Repeat until secure.

If the cable wire moves in the cable carrier, loosen the nut on the carrier, have a second person squeeze the brake arms against the rim, pull the cable wire tight and push the cable carrier up the cable wire as far as possible. Hold the cable wire, cable carrier and brake arms in this position and tighten the nut on the cable carrier. Repeat these steps until secure.

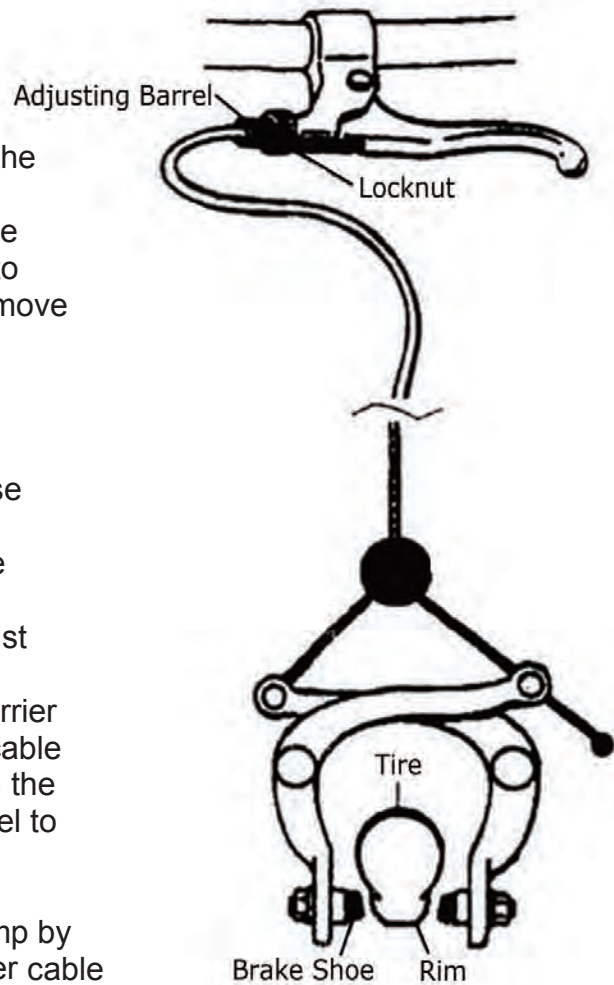

STEP # 8 – REFLECTORS

TYPE A WHEEL REFLECTORS

(may already be assembled)

1. Position the reflector between the left and right layers of spokes opposite the valve stem.
2. Then slide notch in circle of reflector onto spoke and slide the reflector as close to the wheel rim as possible without bending spokes.
3. Push slot in white cap over spoke so the flanges fit into large slots in circle. Twist white cap towards the right with a flathead screwdriver as far as possible. Reflector should be secure. **NOTE:** When assembled, the distance from the center of the reflector to the inside of the wheel rim must be less than 3”(7.6cm)

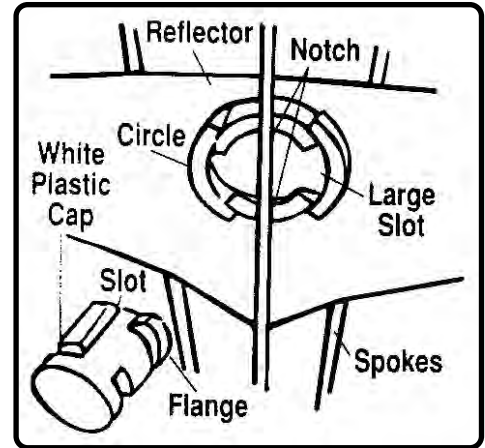

TYPE B WHEEL REFLECTORS

(may already be assembled)

1. Position the reflector between the left and right layers of spokes opposite stem valve
2. Slide notch in circle of reflector onto spoke and slide reflector as close to wheel rim as possible without bending spokes.
3. Attach with screw and hex nut supplied with reflector.

NOTE: When assembled, the distance from the center of the reflector to the inside of the wheel rim must be less than 3”(7.6cm)

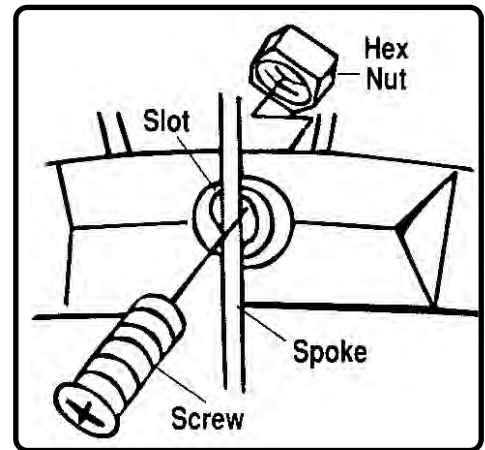

STEP #8 – REFLECTORS continued

FRONT REFLECTOR:

1. Remove the clamp screw from the reflector bracket.
2. Push open the bracket “loop” and slide it onto the handlebar. (If there is a sizing insert included with the bracket, please be sure it is inside the clamp loop before mounting.)
3. Position the reflector bracket on the handlebar between the grip and crossbar, about 5”(12.5cm) from the end of the handlebar. (See illustration)
4. Tighten clamp screw securely.

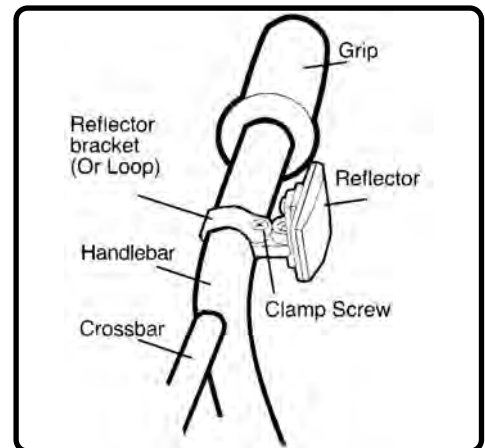

CAUTION: Be sure the reflector is in the same longitudinal

plane as the bicycle (horizontal to the ground). If the reflector is aimed up or down, oncoming headlights may not reflect properly in the reflector.

If the reflector is not horizontal to the ground. Loosen the clamp screw and readjust the angle. Tighten clamp screw securely.

REAR REFLECTOR:

NOTE: Your reflectors may have been preassembled at the factory.

Your rear reflector and bracket are located in the parts box.

NOTICE: It is important to check and adjust the position of the reflectors as you assemble your bike. The reflectors must always be vertical (perpendicular to the ground) and pointed toward the front and rear of the bike. Please make sure that the adjustment is correct as a final step in the assembly of your bike.

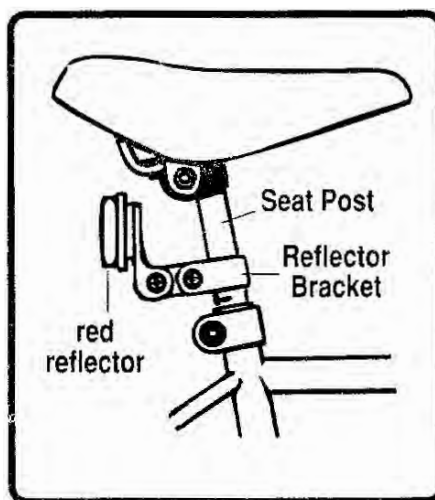

1. Put the seat post mounted rear reflector in the correct position by loosening the screws of the rear reflector bracket.
2. Make sure the rear reflector is vertical to the ground and points straight back
3. Make sure there are at least 3"(7.6cm) of clearance between the top of the seat and the top of the red rear reflector.

STEP #9- INSTALL PEDALS.

WARNING: For safe operation, the pedal spindle must be securely tightened against the crank arm. Always replace damaged pedals, and always wear shoes or sneakers when riding a bicycle.

NOTICE: Start each pedal spindle by hand to avoid stripping the threads.

1. Look for the letters "R" or "L" stamped on the pedal spindle.
2. Thread the pedal marked "R" into the crank arm on the right "chain side" of the bike. Turn the pedal spindle in a clockwise direction. Securely tighten the pedal spindle.
3. Thread the pedal marked "L" into the crake on the left side of the bike. Turn the pedal spindle in a **counterclockwise** direction. Securely tighten the pedal spindle. **NOTE:** Both pedals should be tightened towards the front of the bicycle.

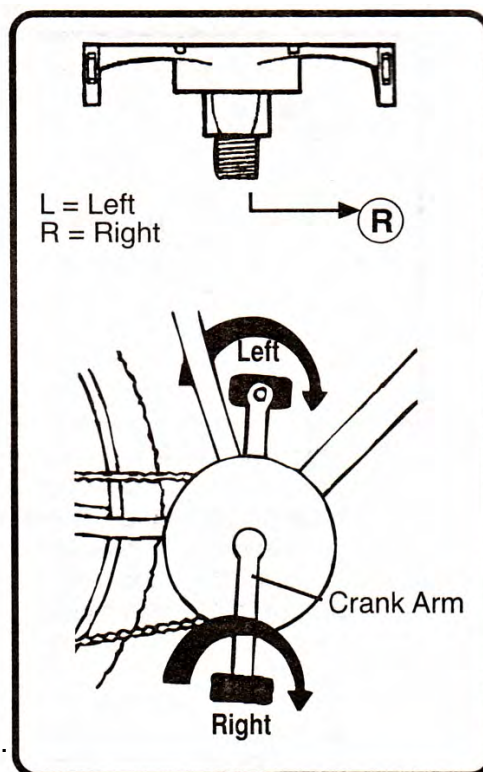

TORQUE REQUIREMENTS PAGE 16

STEP # 10 –AXLE PEG ASSEMBLY

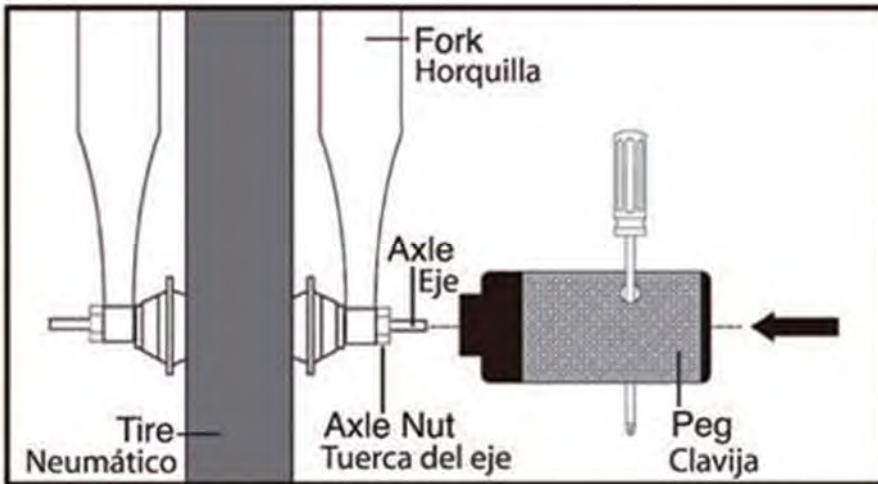

1. Confirm that the axle nut is tightened securely on the axle.
2. Attach the peg to the axle by turning clockwise. A screw driver can be placed through the mounting holes to help in turning peg onto the axle.
3. Tighten against the frame or fork for a snug fit. Repeat for all pegs included.

Note: Some bikes come with 2 pegs, some with 4 pegs. Not all axles are able to accept pegs. The axle should protrude at least an inch from the axle nut to accept pegs. Please consult a qualified bike repair man if you have questions regarding your bike.

WHAT IS TORQUE?

IMPORTANT: Torque is a measurement of how tight a fastener needs to be. A person using a 12 inch(30cm) wrench and applying one pound of force at the end of the handle, puts one foot-pound(ft.-lb.) of torque on a fastener. Torque can be measured with a torque wrench. Torque wrenches are available at most stores that have hand tools.

The ranges of torque in this chart cover many different parts from different manufacturers. To determine the torque value for a part, use the following as a guide.

- a) Torque nuts to the lowest value specified in the range.
- b) If the part continues to move, increase the amount of torque by half the difference from the present torque and the top of the torque range.
- c) If parts start deforming, stop tightening.

DO NOT under tighten fasteners. Part may slip or fail to function.

DO NOT tighten the fasteners too tight. You may damage the thread, which may cause an accident.

TORQUE REQUIREMENTS

PART TO BE TIGHTENED

SUGGESTED TORQUE

Front Axle nut	(22-27 Newton metres)
Handlebar Clamping Bolt	(17-19 Newton metres)
&Nut Stem Expander Bolt	(17-19 Newton metres)
Pedals	(20-26 Newton metres)
Seat	(12-17 Newton metres)
Seat Post Binder Bolt	(15-19 Newton metres)
Rear Axle Nut	(24-29 Newton metres)
Brake Cable fixing Nut	(7-11 Newton metres)
Brake Caliper centre Bolt Nut	(3-5 Newton metres)
Cotterless Crank Nut	(27 Newton metres)

Supplement

Chain Tension Adjustment

To adjust the chain on a coaster brake or three speed bicycle. Loosen the rear axle nuts and move the wheel in the frame. Forwards to loosen and backwards to tighten. When the chain is adjusted, correctly it should have 10-12mm of upwards and downwards movement when held in the centre between the front and rear sprockets.

Brake Block Maintenance

The brake rubbers will be damaged or worn-out after long use. Loosen the anchor bolt nut and the rubber bolt nuts. Replace the damaged rubbers re-tighten the bolt nuts, and then re-tighten the anchor bolt nut.

WARNING: Be sure the anchor bolt and the rubber bolts are fully tightened.

DO NOT ride your bicycle, if the rubber has been damaged or has worn-out.

MAINTENANCE

RECOMMENDED GENERAL MAINTENANCE SCHEDULE

To maintain the original brilliant painted and chrome finish, keep the bicycle clean and dry. Wipe off dirt, moisture and oil clean, soft cloth. Periodically polish with clear coat of wax.

WARNING: Do not use a wax of any kind on the rims of your bicycle. In order for the caliper brakes to operate properly, the rims should be kept clean and free of dirt and lubricants.

Due to wear of new parts, we recommend that you inspect the bicycle frequently for adjustment of brakes, bearings, wheels, etc. Adjust or tighten nuts and screws. The frequency of inspection would depend on how much and how hard you ride. Normally, we recommend a service check at least annually. Any component that does not function properly should be checked and corrected immediately. If you do not feel qualified to make the adjustment, we recommend that you take your bike to a qualified bicycle repair man.

Your bicycle will require maintenance. Although simple in most cases, there are times when the repairs and adjustments take special knowledge and proper tools. We recommend that when service is required. You should have a qualified bicycle repair man do it for you.

FRONT WHEEL REMOVAL

TOOLS REQUIRED – 6”(15cm) ADJUSTABLE WRENCH

1. Place bicycle upside down, resting it on the seat and handlebars. If necessary, remove one caliper brake shoe to allow clearance for wheel removal.
2. Remove axle nuts and depending on your model, washer retainers or axle nuts, washers and wheel retainers.
3. Remove wheel from fork.

NOTE: To assemble front wheel to fork, see front wheel assembly section.

TIRE REMOVAL

Most tires can be removed and replaced by hand. Be careful pinching the tire tube can easily put a hole in it even if you are using tire tools.

1. Remove valve stem cap.
2. Release air from tire by depressing valve stem.
3. Tire should be loose in the rim.
4. Place wheel on floor.
5. Grasp tire with thumbs and fingers of both hands.
6. Lift tire and slide over one side of rim.
7. While holding tire with one hand, peel tire off of wheel rim with other hand.

TIRE INSTALLATION

1. Position tube inside of tire casing.
2. Insert tire valve stem into hole in rim.
3. With tube inside tire casing, roll tire casing onto rim. Be careful not to pinch tube, and be sure that the tube is not twisted in the tire.
4. Hold valve stem while inflating tire to pressure specified on side of tire.

TIRE INFLATION TOOLS REQUIRED – HAND PUMP & TIRE GAUGE

Tires make a big difference in the performance of your bike. When properly inflated and maintained, your tires will give you many miles of wear and service. The following are tips for the proper maintenance and care of tires and wheels.

WARNING: IMPROPER INFLATION IS THE BIGGEST CAUSE OF TIRE FAILURE. DUE TO THE SLIGHTLY POROUS NATURE OF BICYCLE INNER TUBES, IT IS NORMAL FOR YOUR TIRES TO LOSE PRESSURE OVER TIME. FOR THIS REASON, IT IS CRITICALLY IMPORTANT TO MAINTAIN THE PROPER TIRE INFLATION ON YOUR BIKE.

1. Tire pressure is indicated on the sidewall of the tire.
2. Check your tire pressure before each ride by squeezing the tire between your thumb and fingers. It should feel very firm, but not hard. When you sit on your bicycle, the tire sidewalls should not compress very much under your body weight. Check your tire pressure at least once a week with a pressure gauge.
3. Use a hand or foot pump to inflate your tires. NEVER inflate your tires with an air compressor at a gas station. Air compressors release a high volume of air under great pressure. This much air can explode a bicycle tire and tube in a matter of seconds, and may cause serious personal injury. **DO NOT LET CHILDREN INFLATE TIRES.**
4. A bicycle tire will wear out faster when underinflated. An overinflated tire can become unseated from the rim and blow out. Be cautious of both these inflation areas.

RECOMMENDED TIRE PRESSURE 1 P.S.I.=6.9K.P.A

BMX	241-344 k.p.a.	(35-50 p.s.i.)
MTB	276-448 k.p.a.	(40-65 p.s.i.)
Road Touring	483-620 k.p.a.	(70-90 p.s.i.)
Road Racing	755-862 k.p.a.	(110-125 p s i)
Hybrid/Crossbike	414-690 k.p.a.	(60-100 p.s.i.)

BEAD NOT SEATED OR OFF RIM

Deflate tire, seat bead with hands and partially inflate tire for inspection. If the bead is properly seated, inflate to recommended pressure.

SEATING TIRE

After repairing or changing the tires, it is important that the tire is seated properly on the rim.

1. Run your fingers around the bead of the tire to insure it is inside the outer rim ridge.
2. Partially inflate the tire with a hand pump.
3. Inspect the tire to see that:
 - (a) Valve stem is perpendicular to the rim.
 - (b) Tire bead is properly seated inside the rim.
 - (c) Spin tire to see if it is aligned straight on the rim.

TIRE NOT ALIGNED

Partially deflate tire, align using hands. Inflate tire to recommended pressure.

MAINTENANCE Continued

TIRE AND TUBE DAMAGE

To prevent tire cuts, ruptures, rim bruise and star breaks. Avoid rough streets and alleys having glass and other debris. Don't jump curbs. Crooked wheels cause chafing of tires as well as uneven tread wear. Skidding stops decreases the life of the tire due to uneven wear or tread. To prevent distorted tire casings, hang your bicycle up or turn it upside down when storing for long periods.

TRUEING WHEEL

Because this is a difficult procedure, we suggest spoke adjustment be made by a qualified bicycle repairman.

BEARING ADJUSTMENT & LUBRICATION

There are several areas on the bicycle containing bearings that must be adjusted and or lubricated.

Proper maintenance in these areas will insure longer bearing life, and easier and safer riding. Adjustment of the bearings requires special knowledge and tools. We strongly suggest these adjustments be made by a qualified bicycle repairman.

FRONT FORK:

WARNING: IF YOU REPLACE THE FRONT FORK, MAKE SURE THE REPLACEMENT FORK HAS THE SAME RAKE AND SAME TUBE INNER DIAMETER AS THE ONE ORIGINALLY FITTED TO THE BICYCLE.

WARNING: The handlebar hand grips or tube end-plugs should be replaced if damaged, as bare tube ends have been known to cause injury, it is particularly important that if the bicycles used by children be checked regularly to ensure that adequate protection for the ends of the handlebars are in place.

LUBRICATION AND CLEANING

WARNING: Do not use a vegetable base oil to lubricate bike parts. this type of oil may dry and leave a harmful gum residue.

WEEKLY: Wipe bike with a damp cloth. Wipe dry. Polish metal surfaces. On caliper brake models, do not polish rims. Make sure no oil gets on caliper brake shoes. With a spray lubricant, lubricate chain and rear sprocket. On caliper brake models, lubricate hand brake lever cable pivot pints. Wipe seat with a damp cloth and wipe dry.

ANNUALLY: The following components require lubrication, removal, disassembly, installation, special tools and knowledge. It is suggested that this service be performed by a qualified bicycle repair man. Caliper brake cables should be removed from housing and greased. Clean and lubricate wheel bearings, head bearings and crank bearings. Check spokes and wheels and have trued if out of line.

REPLACED WITH DETAILS

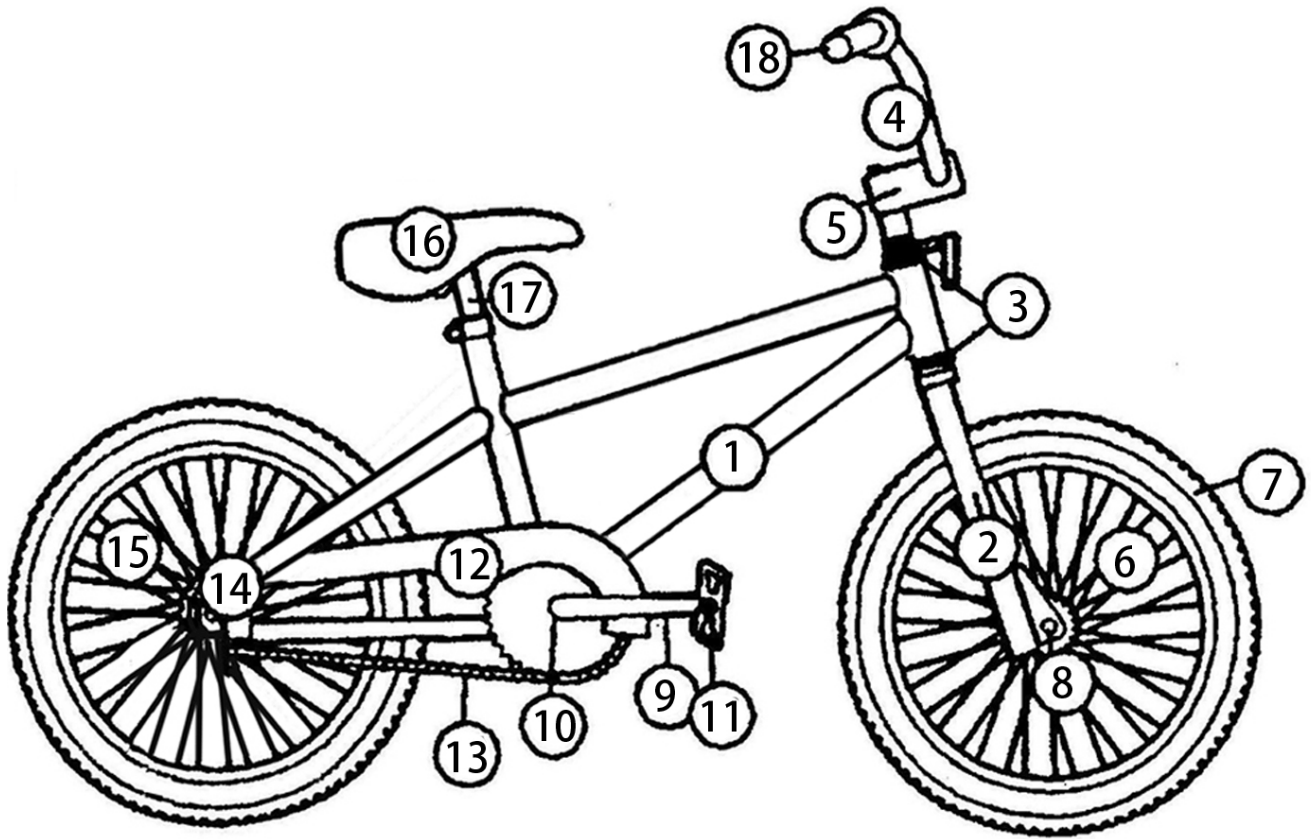

NO. PART

1	Frame	10	Crank Parts
2	Fork	11	Pedals
3	Head Parts	12	Chainguard
4	Handlebar	13	Chain
5	Stem	14	Rear Axle Nuts
6	Front Wheel	15	Rear Wheel W/brake
7	Tire And Tube	16	Seat
8	Front Axle Nuts	17	Seat Post
9	Crank	18	Grips

SAFETY CHECKLIST

Perform each check list below after all assembly instructions and any necessary adjustments have been completed.

Warning: Failure to perform these checks could result in serious injury to yourself and others.

1. **STEERING:** Make certain that the stem is inserted into the head tube to at least the minimum insertion line. Check the clamp nut and stem bolt to make sure they are tightened securely. (See handlebar and stem assembly sections for recommended torque)
2. **BRAKES:** Check and adjust, if necessary (see brake assembly and adjustment section) **WARNING:** Before riding activate front and rear brakes 20 to 25 times then make final brake adjustments. This procedure take care of initial cable stretch.
3. **SEAT:** Check for tightness of seat clamp and seat post clamp and that the minimum insertion line is inside the frame. See that the seat is at the proper height for the intended rider.
4. **PEDALS:** Check pedal spindles making sure they fit tightly against the crank arms.
5. **TIRES:** Check and inflate, if necessary, using a hand pump. **NEVER INFLATE TIRES WITH AN AIR COMPRESSOR AT A PETROL STATION.** The correct pressure is marked on the side of the tire.
6. **GENERAL INSPECTION:** See that all reflectors have been properly installed. Replace any missing or damaged reflectors. Check all fasteners and tighten if necessary.
7. **TO THE RIDER OF THIS BIKE:** Make certain that you know how to operate the bike. We recommend that you read all safety and warning information in the manual before riding.

Before you ride this bicycle, read the Rules for Safe Cycling and check that all parts are installed as per this instruction manual. It is also recommended for added safety and protection that you wear a bicycle helmet.

If you understand how the bicycle operates, you will get the best performance. When you read this instruction book, compare the illustrations to the bicycle. Learn the location of all the parts are assembled correctly and working properly. Take your first ride in a large, open level area. If you have a problem, check the assembly instructions and follow the maintenance procedures in this book.

WARNING ON AND OFF ROAD CONDITIONS: The condition of the riding surface is very important. If the surface is wet, or has sand, small rocks or other loose debris on the surface, carefully decrease the speed of the bicycle and ride with extra caution. It will also take a longer time and more distance to stop. Apply the brake earlier than normal and with less force to help keep the bicycle from sliding.

RULES FOR SAFE CYCLEING

- a) Observe all state and local traffic regulations, signs, and signals. Check with your local police on bicycle licensing and inspection, and where it is legal to ride your bicycle.
- b) Stay on the LEFT SIDE and always ride with the flow of traffic. Never ride two abreast-single file only. Watch out for opening car doors or cars.
- c) Do NOT ride at night. Vision is quite limited at dawn and dusk.
- d) Give pedestrians the right-of-way. Don't ride too close to pedestrians, and don't park your bicycle where it can get in the way.
- e) Avoid road hazards which may hinder your ability to control your bicycle. Potholes, ruts, uneven pavement, railroad crossing, manhole covers, storm grating, soft road edges, gravel, curbs speed bumps, leaves, puddles, and debris can all have effect on your riding and result in loss of control.
- f) Never carry passengers on your bicycle. Never carry packages in your hands or attach anything to your bicycle which could hinder your vision or control.
- g) Don't play in the streets. Use caution at intersections.
- h) Don't wear anything that restricts your hearing.
- i) Always ride with both hands on the handlebars.
- j) Don't wear extremely loose clothing which could hang down and get caught in the wheels of your bicycle. Wear a cuff hand or trouser clip to keep your pants from getting caught in the chainwheel.
- k) Always wear proper safety equipment. A helmet, long sleeved shirt, ling pants, shoes, and elbow and knee pads are suggested. Gloves and eye protection also make good sense.
- l) Cover your stem, handlebar, and top tube with safety pads for additional protection.
- m) Do not ride bicycle if chain cover is not attached.

**ALWAYS WEAR A HELMET -
IT COULD SAVE YOUR LIFE!**



12 MONTH WARRANTY

Thank you for your purchase from Kmart.

Kmart Australia Ltd warrants your new product to be free from defects in materials and workmanship for the period stated above, from the date of purchase, provided that the product is used in accordance with accompanying recommendations or instructions where provided. This warranty is in addition to your rights under the Australian Consumer Law.

Kmart will provide you with your choice of a refund, repair or exchange (where possible) for this product if it becomes defective within the warranty period. Kmart will bear the reasonable expense of claiming the warranty. This warranty will no longer apply where the defect is a result of alteration, accident, misuse, abuse or neglect.

Please retain your receipt as proof of purchase and contact our Customer Service Centre on **1800 124 125 (Australia) or 0800 945 995 (New Zealand)** or alternatively, via Customer Help at Kmart.com.au for any difficulties with your product. Warranty claims and claims for expense incurred in returning this product can be addressed to our Customer Service Centre at **690 Springvale Rd, Mulgrave Vic 3170.**

Our goods come with guarantees that cannot be excluded under the Australian Consumer Law. You are entitled to a replacement or refund for a major failure and compensation for any other reasonably foreseeable loss or damage. You are also entitled to have the goods repaired or replaced if the goods fail to be of acceptable quality and the failure does not amount to a major failure.

For New Zealand customers, this warranty is in addition to statutory rights observed under New Zealand legislation.