

Kmart Bicycle Owner's Manual

Children's Bicycles

ItemNo.: 42624080

ItemName: 30CM PINK WHIRL

**IT IS IMPORTANT TO READ THIS MANUAL THOROUGHLY
BEFORE ASSEMBLING, RIDING, OR PERFORMING
MAINTENANCE ON THIS BICYCLE.
KEEP THIS MANUAL FOR FUTURE REFERENCE.**

Contents

| | | |
|----|----------------------------|----|
| 1. | Parts identification | 1 |
| 2. | Safety precautions | 2 |
| 3. | Check list | 6 |
| 4. | Assembly | 7 |
| 5. | Adjustment | 14 |
| 6. | Repair and Service | 15 |
| 7. | Warranty | 22 |

NAME OF BICYCLE PARTS

NOTE: Not all the component or all bicycle types are shown.



SAFETY PRECAUTIONS

Owner's Safety Information and Responsibility

To reduce the risk of serious personal injury, you should read the instruction in this manual carefully.

There are  **WARNINGS** throughout this manual, please follow all **WARNING** instructions.

 **WARNING: This bicycle is made to be ridden by one rider at a time for general transportation and recreational use. It is not made to withstand the abuse associated with stunting and jumping.**

1. The bicycle has been supplied partial assembled. It is owner's responsibility to read and follow all the assembly and adjustment instructions exactly as written in this manual. Or you may ask a vehicle mechanic to assemble this bicycle.
2. Know how to operate all standard and accessory equipment on the bicycle.
3. Your bicycle conforms to relevant Australian Standards. Other local bicycle regulations may apply. Check with your retailer.



WARNING: Read through the following Rules of the Road to reduce the injury to the rider or to others.

Rules of the road

1. Obey the road rules at all times, such as traffic signals, signs and giving way to pedestrians.
2. Always wear a bicycle helmet that meets the local safety standards. Always ensure that appropriate footwear is worn whilst riding this bike.
3. Always ride in the same direction as the traffic. Never ride against the traffic.
4. Avoid the following hazards: Drain gratings, soft road edges, gravel or sand, pot holes or ruts, wet leaves, or uneven paving.
5. When crossing railroad tracks do so carefully at a 90 degree angle to prevent loss of control.
6. Do not carry packages or object that obstruct your vision or control.
7. Do not carry passengers.
8. Do not ride with both hands off the handlebars.
9. Use hand signals. Indicate intended actions, such as turning or stopping, by using appropriate hand signals.
10. If there is front brake, apply the rear brake first, and then apply the front brake. The front brake is strong and if not used correctly you may lose control and fall.
11. Do not use items that may impede your hearing. E.g. head phones.
12. Ride predictably and in a straight line.

Wet Weather

1. Use extra caution in wet weather.
2. Avoid sudden braking
3. Apply brakes sooner in wet conditions, as stopping distance increase in weather.
4. Slow overall riding pace and approach corner more carefully.

Night Riding

Avoid riding at night if possible, if you choose to ride at night:

1. Purchase, install, and use a front and rear bicycle light.
2. Make sure the reflectors of your bicycle are correctly positioned.
3. Use a flashing rear light to improve visibility.
4. Wear light-colored reflective clothing, such as a reflective vest and reflective bands for your arms and legs.



Right Way



Wrong Way

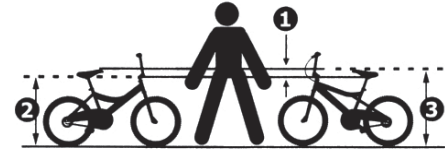

WARNING: Always wear a correctly fitted and fastened helmet when riding your bicycle.

To determine the correct size of the bicycle for the rider.

Straddle the assembled bicycle with feet shoulder with width apart and flat on the ground.

There must be at least 25.4mm of clearance between the highest part of top tube (2) and the cloth of the rider.

The minimum leg-length for the rider is the highest part of the top tube plus 25.4mm

The rider must be able to easily reach and operate the brake levers (if so equipped).

The seat position must be adjustable so that the feet of rider can reach the ground.

Tools required(Not included in the packing)

Phillips head screwdriver;

adjustable wrench or an 8mm, 10mm, 13mm,14mm

15mm open and box end wrenches;Allen Keys;

A plier with cable cutting ability; Air pump

Keep a Record of Your Bicycle

Each bicycle has a Serial Number stamped into the bottom of the frame. Write down this number to keep it for future reference. Take a colour photograph of your bicycle, write the Serial number on the back of the photograph and keep it in a safe place. If you keep a record of the details of your bicycle it will greatly increase the possibility of getting it back should it be lost or stolen.

Remember the advice about LOCKING YOUR BICYCLE. A good quality lock is cheap insurance.

Safety check list

Before riding, it is important to carry out the following safety checks:

1. Nuts and bolts

Check and tighten any loose nuts, bolts and straps. If you're not sure, ask your bicycle retailer to check.

2. Brakes

Check that the brakes operate effectively.

3. Wheels and Tyres

Check by pushing down with your thumb on the top of the tyre. The tyre should depress slightly, Compare to how it feels when you know the tyres are correctly inflated. Replace damaged tyres before they puncture.

Spin each wheel and check for brake clearance and side –to –side wobble. If a wheel wobbles or hits the brake pads, take the bicycle to your bicycle retailer.

4. Handlebar and Saddle

Tighten them so they do not move and are horizontal. Check the handlebar is in good condition and the ends of the handlebar are plugged. Check the bell is fitted and working well.

Warning: Handlebar grips and tube end plugs should be replaced if damaged, as bare ends have been know to cause injury. Please check the condition of grips and bar ends before rdie.

5. Chain

Ensure the chain is oiled, clean and runs smoothly.

6. Accessories

Ensure that all reflectors are properly fitted and not obscured.

Bicycle Assembly

1. Front Wheel

Assemble the front wheel to the fork as shown

(Shown with bike sitting upside-down.)

! WARNING: If you remove a brake shoe to install the front wheel, return it to the correct position as written in the "Brake and cable adjustment" Section.

- Make sure the tab of each security washer (2) is in the hole of the fork.
- Using the two axle nuts (3) with serrations, attach the front wheel.

! WARNING: Do not use the nuts without serrations to attach the front wheel.

put the wheel in the center of the fork and tighten both nut to the recommended torque of 25-28N.M.

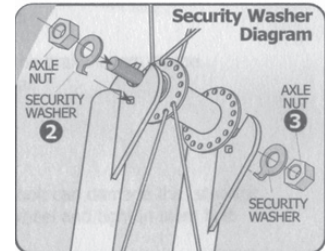
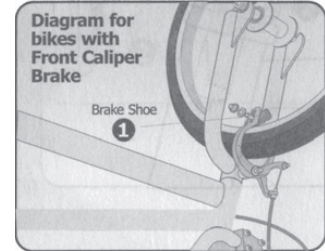
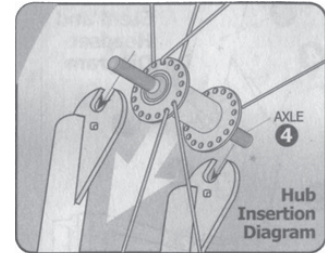

2. Training Wheel

Attach the legs to the bicycle frame:

Put the alignment insert (1), a leg (2) and an axle nut (3) on each end of the rear wheel axle (4).

Make sure the tab of the alignment insert (5), is to the rear of the axle and in the slot (6) of the frame.

Make sure both training wheels are the same distance from the ground.

Tighten the axle nuts securely.

! WARNING: Before each ride, make sure both nuts are tight.

Also make sure both training wheels are the same distance from the ground.

As your child's ability and balance improve, you may raise or remove the training wheels.

To move the training wheels loosen the nut, slide the leg to the correct position, and retighten the nut.

To remove the training wheels, remove the nut, leg, and alignment insert.

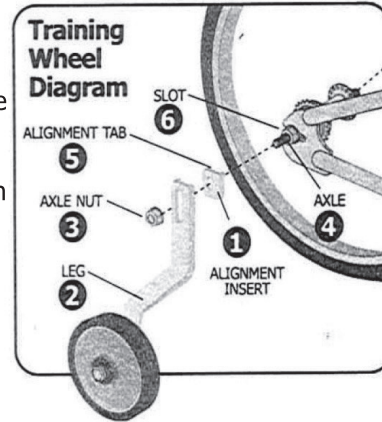

3. Install Pedals

All pedals have L or R stamped on the threaded spindle of each pedal.

1. Thread the pedal marked R clockwise into the right or chain wheel side of the crank arm.
2. Thread the pedal marked L counter-clockwise into the left side of the crank arm.

NOTE: Hand thread pedals into position without use of a wrench to ensure threads are not crossed threads. Damage to crank arm will result from crossed threads. When tightening with a wrench, make sure each spindle is firmly seated against the crank arm. If Jaws of wrench are too thick, they may prevent proper tightening of pedal spindle against crank arm.

4. Install Saddle

1. Insert the seat post into bicycle frame tube with small swaged end up.

Note: Seat post must be inserted at least to minimum insertion mark stamped on the lower part of the post.

2. Tighten the seat post clamp nut or quick release securely. Recommended torque is 12-17N.M.
3. Loosen saddle clamp nuts or quick release so saddle clamp will fit down fully onto top swaged end of seat post.
4. Tighten seat post bolt. Recommended torque is 12-17N.M.

Note: If there is rear reflector, please install the rear reflector to the seat post before insert to the seat tube.

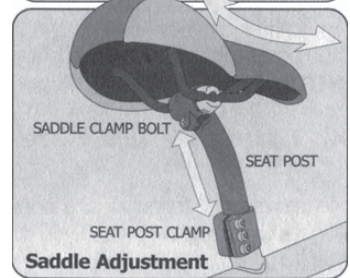
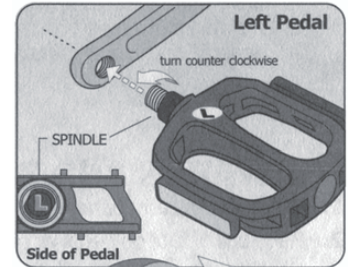
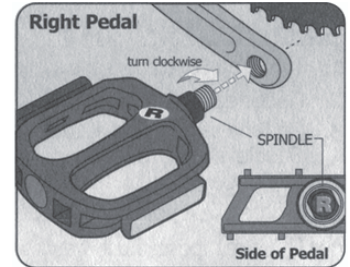

Handlebar and Stem

1. Assemble the stem to the fork: If necessary, assemble the stem bolt (4), washer (5), and wedge nut (2) to the stem (1). Turn the stem bolt only four revolutions into the wedge nut.

Turn the stem bolt only four revolutions into the wedge nut (2). Point the stem toward the front of the bicycle and put it into the locknut (7). Put the stem at a comfortable height for the rider.

⚠ WARNING: To prevent steering system damage and possible loss of control, the MIN-IN (minimum insertion) mark on the stem must be inside the locknut.

Make sure you can not see the MIN-IN (minimum insertion) mark (3) on the stem above the locknut. Tighten the stem bolt just enough that the stem will not fall into the locknut.

2. Assemble the handlebar to the stem:

Put the handlebar (8) into the stem, but do not tighten the handlebar clamp (6) at this time.

Align the stem with the front wheel and tighten the stem bolt

3. Assemble the brake lever to the handlebar. Loosen the clamp screw of each brake lever.

If necessary, move the handlebar to each side to install the brake levers put the brake levers on the handlebar with the brake lever for the rear brake on the right side of handlebar.

Do not tighten the clamp screw of the brake levers at this time.

4. Tighten stem bolt and the handlebar clamp:

⚠ WARNING: do not overtighten the stem bolt. Over tightening the stem bolt can damage the steering and cause loss of control. Make sure the stem is aligned with the front wheel and tighten stem bolt

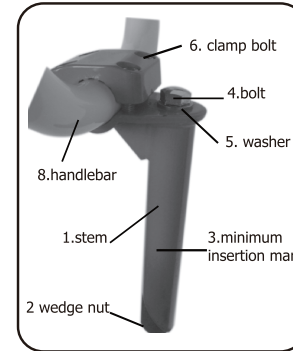

Stem and headset Diagram

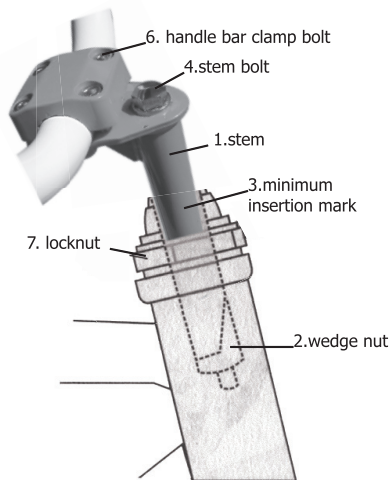

Handlebar and Stem (continued)

Put the handlebar in a comfortable position for the rider

⚠ WARNING: if the handlebar clamp is not tight enough, the handlebar can slip in the stem. This can cause loss of control

Tighten the bolts of the handlebar clamp. If the handlebar clamp has more than one bolt, than tighten the bolts equally.

5. Test the tightness of the stem: straddle the front wheel and hold it between your legs.

Try to turn the front wheel by turning the handlebar. If the handlebar and stem turn with out turning the front wheel, realign the stem with the front wheel.

Tighten the bolt tighter than you did before (about half a revolution only at a time).

Do this test again, until the handlebar and stem do not turn without turning the wheel

6. Test the tightness of the handlebar: Hold the bicycle stationary and try to move the ends of the handlebar forward or backward. If the handlebar moves, loosen bolts of handlebar clamps. Put the handlebar in the correct position

Tighten the bolts of the handlebar clamp tighter than before. If the handlebar clamp has more than one bolt, tighten the bolts equally

Do this test again, until the handlebar does not move in the handlebar clamp.

4-bolt-stem instructions

Notice:

1. Align the stem in the steer tube so that the handlebar is perpendicular with the front wheel.
2. Ensure the minimum insertion mark on the stem is not visible- beneath the top of the steer tube.
3. Tighten the stem bolt enough so that stem will not rotate in the steer tube.
4. Check the rotation with firm pressure.

Steps:

1. Adjust and tighten the handlebar in the stem.
 2. Tight the 4 bolts in a cross pattern, and ensure they clamp evenly.
 3. Tighten the handlebar clam nuts enough so that handlebar will not rotate in the stem.
- Check handlebar rotation with slight pressure.

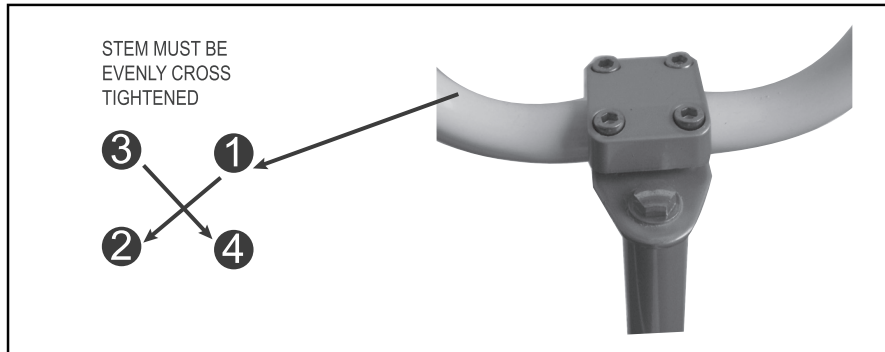

Assemble the Accessories

1. Assemble the crash pad

Assemble the pads in the correct location as shown. Attach with the sewn-in Velcro fasteners.



2. Bell

The bell is attached to the handlebar. Adjust the bell ring to the comfortable place that is easily to be used when riding.

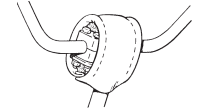

3. Front reflector (Not Applicable)

Assemble the clear reflector to the front reflector bracket.

Warning: Install the clear reflector exactly as instructions or it will not operate correctly.

Assemble the reflector bracket onto the handle bar stem. Make sure the clear reflector is vertical, point toward the front of the bicycle.

Tighten the screw with Phillip screwdriver.

4. rear reflector (Not Applicable)

Assemble the red reflector onto the seat post. Make sure the red reflector is vertical, point toward the rear of the bicycle.

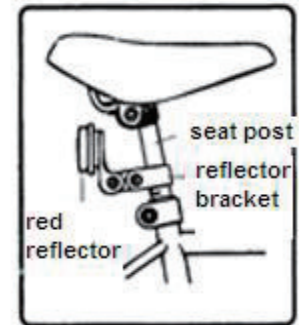

Coaster Brake

APPLY PRESSURE TO SLOW DOWN OR STOP

The coaster brake is a sealed mechanism, which is a part of the bicycle's rear wheel hub. The brake is activated by reversing the rotation of the pedal cranks (see the coaster brake diagram). Start with the pedal cranks in a nearly horizontal position, with the front pedal in about the 4 o'clock position, and apply downward foot pressure on the pedal that is to the rear. The more downward pressure you apply, the more braking force, up to the point where the rear wheel stops rotating and begins to skid.

 **CAUTION:** Before riding, make sure that the brake is working properly. If it is not working properly, have the bicycle checked by your dealer before you ride it.

Adjusting your coaster brake

Coaster brake service and adjustment requires special tools and special knowledge. Do not attempt to disassemble or service your coaster brake. Take the bicycle to your dealer for coaster brake service.



APPLY PRESSURE TO SLOW DOWN OR STOP

Repair and Service

! WARNING: Inspect the bicycle frequently. Failure to inspect the bicycle and to make repairs or adjustments, as necessary can result in injury to the rider or to others. Make sure all parts are correctly assembled and adjusted as written in this manual and any Special Instructions

Rear Wheel and chain Adjustment

Maintenance: The chain must be at the correct tightness. If too tight, the bicycle will be difficult to pedal. If too loose, the chain can come off the sprockets.

! WARNING: The chain must remain on the sprockets. If the chain comes off the sprockets, the coaster brake will not operate.

When the chain (1) is at the correct tightness, you can pull it one-half inch (2) away from a straightedge (3) as shown.

Adjust the tightness of the chain as follows:

Loosen the axle nuts (4) of the rear wheel.

Loosen the clamp (5) on the brake arm(6),but do not remove the nut and screw from the clamp.

NOTE: Make sure that rear wheel is in the center of the bicycle frame.

Move the rear wheel forward or backward as necessary, until you can pull the chain on half inch away form a straightedge, Hold the wheel in the position and tighten the axle nuts to the recommended torque of 25-28N.M.

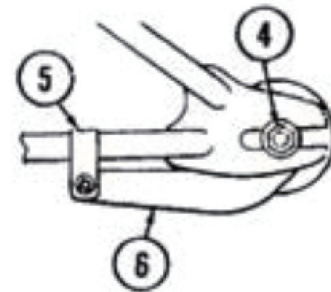
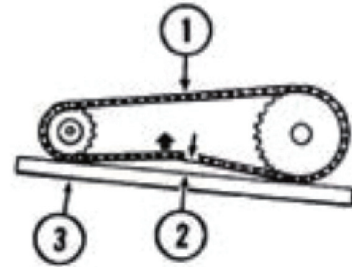

TYRE REMOVAL

1. Let the air out of the tyre by depressing the valve core (the little pin in the centre of the valve stem opening).
2. Separate the tyre bead from the sides of the rim by pressing with your thumbs. Work your way around the tyre on both sides to be sure that the beads of the tyre are not sticking to the rim. (Figure A)
3. Stand the wheel up on the firm surface with the valve stem on the bottom and grasp the upper part of the tyre with both hands. Try to roll the tyre off the far side of the rim.
4. With the wheel standing as in Figure B, use bicycle tyre tools for spoon handles with rounded ends (at least two-preferably three) to lift the bead on one side of the tyre off the rim. Be careful not to pinch the inner tube between the tyre tools and the tyre bead or rim. Once you have got the bead off for about one fourth of the circumference of the tyre using the tools, the rest can usually be pulled off by hand.
5. With the bead on one side of the tyre completely off the rim, you can now pull the inner tube out from between the tyre and rim everywhere except in the area of the valve stem.
6. It should now be easy to pull the tyre the rest of the way off the rim. Start at the side of the wheel opposite the valve stem and simply lift the bead of the tyre up over the side of the rim and pull it off.

FIGURE A

Press with thumbs to separate tyre bead. Continue around entire rim until the bead is completely separated.



FIGURE B

Lift bead with spoons or tyre tools.



FIGURE C

replace tyre onto rim.



FIGURE D

Rims strip protects inner tube from spoke ends.

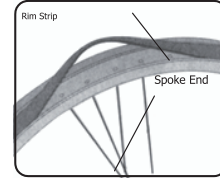

FIGURE F

Use thumb to press valve stem through hole in rim. Make certain valve stem is straight.



Frequently check the tyre inflation pressure because all tyres lose air slowly over time. For extended storage, keep the weight of the bicycle off the tyres.

Inflation: maintain tyre pressure at the level recommended on the tyre sidewalls.

Conversion from PSI to kilopascals is listed below:

40PSI=275Kpa 35PSI=241Kpa



WARNING: Do not ride or sit on the bicycle if either inner tube is under inflated. This can damage the tyre and inner tube. Do not use unregulated air hoses to inflate the inner tubes. An unregulated hose can suddenly over inflate bicycle tyres and cause them to burst.

Use a hand or a foot pump to inflate the inner tubes. Service station meter-regulated air hoses are also acceptable. The correct inflation pressure is shown on the tyre sidewall.

Before adding air to any tyre, make sure the edges of the tyre (the bead) is the same distance from the rim, all around the rim, on both sides of the tyre. If the tyre does not appear to be seated correctly, release air from the inner tube until you can push the bead of the tyre into the rim where necessary, add air slowly and stop frequently to check the tyre sealing and the pressure, until you reach the correct inflation pressure as indicated on the tyre sidewall. Replace worn or defective tyres and inner tubes.

Recommended torque requirement:

(A) Front axle nuts: 25-28N.M (B) back axle nuts: 25-28N.M

(C) Handlebar clamp nut/bolt (4 bolt type): 9-13N.M (1 bolt type): 21-25N.M

(D) Handlebar stem expander bolt: 17-19N.M (E) seat pillar clamp nut/bolt: 12-17N.M

(F) brake cable anchor bolt: 7-11N.M (G) brake mounting bolt: 6-8N.M

(H) Seat clamp nuts: 12-17N.M

(I) crank attachment systems: 24-30N.M

It is recommended that a torque wrench is used during assembly bicycle.

Inspection of Bearings

Maintenance: Frequently check the bearings of the bicycle. Have a bicycle service shop lubricate the bearings once a year or any time they do not pass the following tests.

Head Tube Bearings: The fork should turn freely and smoothly at all times. With the front wheel off the ground, you should not be able to move the fork up, down, or side-to-side in the head tube.

Crank bearings: The crank should turn freely and smoothly at all times and the front sprockets should not be loose on the crank. You should not be able to move the pedal end of the crank from side-to-side.

Wheel bearing: Lift each end of the bicycle off the ground and slowly spin the raised wheel by hand. The bearings are correctly adjusted if:

The wheel spins freely and easily. The weight of the spoke reflector when you put it toward the front or rear of the bicycle causes the wheel to spin back and forth several times. There is no side-to-side movement at the wheel rim then you push it to the side with light force.

Lubrication/Maintenance

 **WARNING: Do not over lubricate. If oil gets on the wheel rims or the brake shoes, it will to reduce brake performance and a longer distance to stop the bicycle will be necessary. Injury to the rider or to others can occur.**

The chain can throw excess oil onto the wheel rim. Wipe excess oil off the chain.

Keep all oil off the surfaces of the pedals where your feet rest.

Using soap and hot water wash all oil off the wheel rims, the brake shoes, the pedals, and the tyres. Rinse with clean water and dry completely before you ride the bicycle.

Using a light machine oil (20W) and the following guidelines, lubricate the bicycle:

| What | When | How |
|----------------|------------------|------------------------------------------------------------------------------------------------------|
| Brake Levers | every six months | Put one drop of oil on the pivot point of each brake lever |
| Caliper Brakes | every six months | Put one drop of oil on the pivot point of each caliper brake |
| Brake Cables | every six months | Put four drops of oil into both ends of each cable. Allow the oil to soak back along the cable wire. |
| Pedals | every six months | Put four drops of oil where each pedal axle goes into the pedal. |
| Chain | every six months | Put one drop of oil on each roller of the chain. Wipe all excess oil off the chain. |

Normal Repair Kits

Some parts of the bicycle will be easily worn down, Below is the normal repair kits for future use.

- 1.Spare inner tube ;
- 2.Patch kits
- 3.Pump
- 4.Tire levers
- 5.Multi tools

It is recommended that significant mechanical repairs should be carried out by a skilled bicycle mechanic.



WHEELS

Wheel inspection

It is most important that wheels are kept in top condition. Properly maintaining your bicycle's wheels will help braking performance and stability when riding. Beware of the following potential problems:

Dirty or greasy rims:

Caution: these can render your brakes ineffective. Do not clean them with oily or greasy material. When cleaning, use a clean rag or wash with soapy water, rinse and air dry, don't ride while they're wet.

When lubricating your bicycle, don't get oil on the rim braking surfaces.

Wheels not straight:

Lift each wheel off the ground and spin them to see if they are crooked or out of round. If wheels are straight, they will need to be adjusted. This is quite difficult and is best left to a bicycle specialist.

Broken or loose spokes:

Check that all spokes are tight and that none are missing or damaged.

Caution: such damage can result in severe instability and possibly an accident if not corrected.

Again, bicycle specialist beat handle spoke repairs.

Loose hub bearings:

Lift each wheel off the ground and try to move the wheel from side to side.

Caution: if there is movement between the axle and the hub, do not ride the bicycle. Adjustment is required.

Axle nut

Check that these are tight before each ride.

Fork replacement:

If you choose to replace the front fork, please ensure that the fork is the same size and inner tube diameter as the original fork that was sold with the bicycle.

Lubrication and Adjustment – One Piece Cranks

To adjust the free play in a one piece type bottom bracket, loosen the locknut on the left side by turning it clockwise and tighten the adjusting cone counter-clockwise using a screwdriver in the slot. When correctly adjusted, re-tighten the locknut counter-clockwise. To disassemble:

1. Remove the chain from the chainwheel
2. Remove the left pedal by turning the spindle clockwise
3. Remove the left side locknut by turning it clockwise and remove the keyed lockwasher.
4. Remove the adjusting cone by turning it clockwise with a screwdriver.
5. Remove the left ball retainer, slide the crank assembly out of the frame to the right, and remove the right ball retainer.

Clean and inspect all bearing surfaces and ball retainers, and replace any damaged parts. Pack the ball bearing retainers with grease, then re-assemble in the reverse of the above procedure.

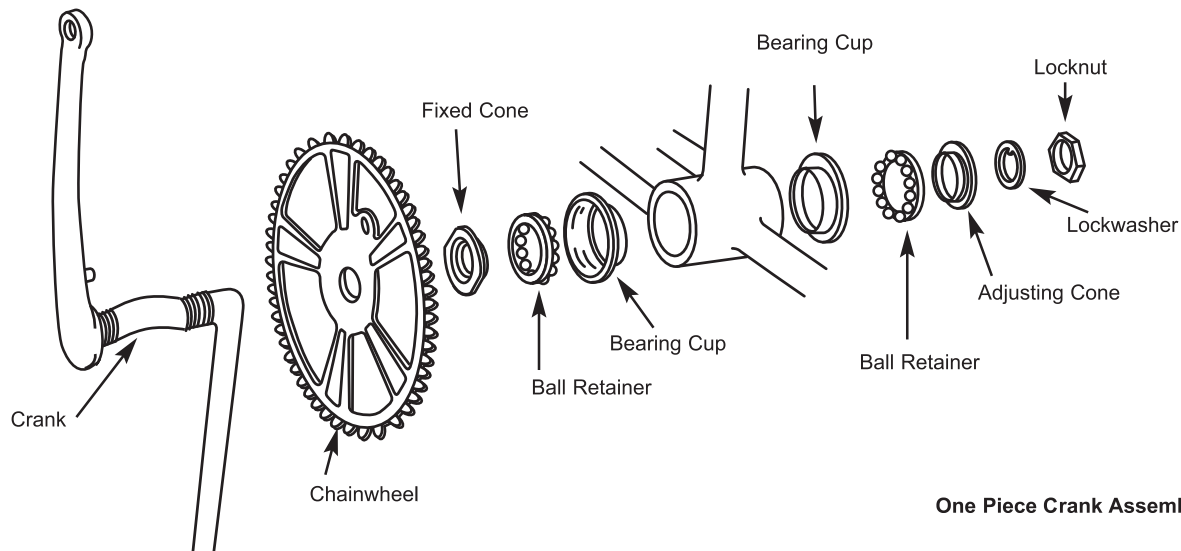

One Piece Crank Assembly

12 Month Warranty

Thank you for your purchase from Kmart.

Kmart Australia Ltd warrants your new product to be free from defects in materials and workmanship for the period stated above, from the date of purchase, provided that the product is used in accordance with accompanying recommendations or instructions where provided. This warranty is in addition to your rights under the Australian Consumer Law.

Kmart will provide you with your choice of a refund, repair or exchange (where possible) for this product if it becomes defective within the warranty period. Kmart will bear the reasonable expense of claiming the warranty. This warranty will no longer apply where the defect is a result of alteration, accident, misuse, abuse or neglect.

Please retain your receipt as proof of purchase and contact our Customer Service Centre on 1800 124 125 (Australia) or 0800 945 995 (New Zealand) or alternatively, via Customer Help at Kmart.com.au for any difficulties with your product. Warranty claims and claims for expense incurred in returning this product can be addressed to our Customer Service Centre at 690 Springvale Rd, Mulgrave Vic 3170.

Our goods come with guarantees that cannot be excluded under the Australian Consumer Law. You are entitled to a replacement or refund for a major failure and compensation for any other reasonably foreseeable loss or damage. You are also entitled to have the goods repaired or replaced if the goods fail to be of acceptable quality and the failure does not amount to a major failure.

For New Zealand customers, this warranty is in addition to statutory rights observed under New Zealand legislation.

