

# anko

**USER MANUAL**

**Bluetooth® Micro System**

**42776550**



**CATALOGUE**

SAFETY INSTRUCTIONS..... 2  
 PRECAUTIONS ..... 3  
 PANEL INSTRUCTION..... 4  
 REMOTE CONTROL ..... 5  
 GET STARTED..... 6  
 BASIC OPERATION ..... 7  
 RADIO OPERATION ..... 8  
 AUDIO OUTPUT AND INPUT..... 9  
 BLUETOOTH OPERATION ..... 10  
 USB OPERATION ..... 11  
 TROUBLESHOOTING GUIDE..... 12  
 SPECIFICATION ..... 13  
 WARRANTY..... 14

**CLASS 1 LASER PRODUCT**

**CAUTION !**  
 THIS PRODUCT UTILIZES A LASER. USE OF CONTROL OR ADJUSTMENTS OR PERFORMANCE OF PROCEDURES OTHER THAN THOSE SPECIFIED HEREIN MAY RESULT IN HAZARDOUS RADIATION EXPOSURE. DO NOT OPEN COVERS AND DO NOT REPAIR YOURSELF. REFER SERVICING TO QUALIFIED PERSONNEL.

This CD Player adopts semiconductor unit, not including spare parts for users to replace. Don't take apart the machine by yourself to avoid electric shock. If the machine is damaged, please ask the qualified maintenance worker to repair.

**POWER**  
 Power of this player should be used corresponding to the information on the rating label.

**VENTILATION**  
 5cm minimum distances around the CD player for sufficient ventilation. The function of air vent on the main case is to keep CD Player from overheating. Don't block or cover the air vent and put the player on the bed or sofa. The ventilation should not be impeded by covering the ventilation openings with items such as newspaper, table-cloths, curtains etc.

**HEAT SOURCE**  
 The machine should be kept away from heat source, such as stoves and direct sunlight.

**NAKED FLAME SOURCE**  
 The machine should be kept away from naked flame sources, such as lighted candles should be not placed on the machine.

**WATER AND MOISTURE**  
 Don't use this machine in the humid environment, such as bathroom, kitchen, humid basement and so on.  
 Caution:  
 The apparatus shall not be exposed to dripping or splashing and that no objects filled with liquids, such as vases, shall be placed on apparatus.

**CLEANING**  
 Before cleaning, please put the power off first. Don't use liquid cleaners or corrosive fluid to clean the machine, just clean it by a soft cloth.

**POWER**  
 While inserting or pulling out power cord, grip the plug not the wire. If do not use the machine for a long time, please pull out power cord. To be completely disconnect the power input, the

mains plug of machine shall be disconnected from the mains. The mains plug of machine should not be obstructed OR should be easily accessed during intended use.

**DISC TRAY DOOR**  
 While closing the disc tray door, keep fingers away from it to avoid being damaged.

**LOADING WEIGHT**  
 Don't put any heavy objects on the machine in order to keep the machine from being damaged.

**CONNECTING OTHER EQUIPMENTS**  
 Before connecting other equipments with the CD Player, make sure to put off the power. Otherwise, it will make equipments or users damaged.

**Radium Laser**  
 While the case is open and the CD Player is working, don't look at the laser directly with naked eyes, otherwise, it will have a bad influence on the eyesight.

**DISC**  
 Avoid using the disc which is cracking, deformed or repaired, otherwise, the machine will appear malfunction or shorten usage life.

**MALFUNCTION REQUIRING MAINTANENCE**  
 If the following problems appear, please put off the power, and contact the qualified maintenance worker.  
 A. The power cord or plug is damaged.  
 B. Liquid or other foreign matters in the unit.  
 C. The machine is caught in the rain or watered.  
 D. While the machine can't work even according to the manual operation, don't press other button which aren't mentioned on the manual. Otherwise, it will cause the machine damaged and take the maintenance worker more time to fix .  
 E. The machine drops from high place.  
 F. The inner part gives out a burnt smell.

**Maintenance**  
 If you aren't familiar with the maintenance technical skill of the machine, don't try to fix it by yourself. If you open the main case, you might be get electric shock. If needed, contact the qualified maintenance worker.

**SAFETY INSPECTION**  
 After maintenance, requesting maintenance worker to implement site safety inspection to make sure the machine works safely.

**NOTE:**  
 The use of apparatus in moderate climates. Please read the manual carefully before using the machine, and keep it well for using in the future.

## PRECAUTIONS

1. When carrying the CD Player, use the original shipping carton and packing materials. It's the best way to protect the play with the factory package.

2. Don't place the CD Player nearby volatile liquid, and don't let the rubber or plastics product to connect with the player for a long time, which will leave traces on the machine cover.

3. After working for a long time, the upper cover or rear panel will give out heat, which belongs to normal phenomenon not malfunction.

4. While not using the CD Player, please take disc out and close the disc chamber, then turn off the power.

5. While not using the CD Player for a long time, some functional button may not work. In order to avoid appearing that phenomenon, advise to use it for a while or pay attention to moistureproof.

### LOCATION PRECAUTIONS

While placing the CD Player at the side of TV, Radio or Video Recorder, it may appear phenomenon like the picture showed not clear or the sound loses true. Therefore, keep the CD Player away from that kind of equipment.

### CLEANING PRECAUTIONS

1. Cleaning by a soft cloth
2. Using a cloth with a little bit diluted detergent to wash the stain. Please remind that don't use any dissolvent such as thinner, gasoline solvents and volatile liquid, for which will damage the player cover.
3. Using chemical soaked cloth to clean the CD Player, Please wash the player according to the usage instruction.

**NOTE:** Cleaning and adjusting interior parts have to be operated by qualified maintenance worker, otherwise damage the player or shorten usage life.

### DISC USAGE PRECAUTIONS

1. How to get a disc: don't touch the side of playing



2. Cleaning Disc: clean the disc from the center to outside by a soft cloth. If the picture and sound quality was influenced because of fingerprints or dust on the disc, wiping the disc by a wet cloth and then wiping by a dry cloth. Don't use Dissolved in toluene, detergent or Anti static spray to wash the disc, or damage it.



3. Storing the disc: placing the disc to the disc box instead of humid or dusty place and direct sunshine place.



### BATTERY PRECAUTIONS

If using batteries incorrectly, the battery fluid would leak or the battery will be corroded. Therefore, please operate correctly as the following instruction.

1. While putting batteries into remote control, don't take anti to the positive and negative polarity of the battery.

2. Don't charge the battery (not rechargeable batteries), disassemble and decompose the battery or put it into fire.

3. Don't use different models batteries together or new batteries with old ones.

4. Don't leave damaged or dead battery into the remote control.

5. If not using the remote control for a long time, put batteries out to protect it from being damaged for battery fluid leaking.

6. If the remote control work abnormally or effective picture narrows, replace new batteries.

7. If battery fluid leaks, clean the battery case first and then replace new battery.

### REMOTE CONTROL PRECAUTIONS

If using the remote control incorrectly, it would appear that the CD Player reception is not good enough or there is no reception. Therefore, please use it correctly as following instructions.

1. Keeping remote control launch head from being illuminated directly by intensive light source like sunlight, which leads to no reception or bad reception.

2. Put the remote control aim at the receiving window on the CD Player.

3. Don't drop the remote control or shock intensively.

4. Don't put water or other liquids into the remote control.

5. Don't take apart the remote control.

### NOTE:

1. Keep the distance about 7 meters between the remote control and the CD Player.

2. Keep omnibearing 30 degrees from the remote to receiving window.

3. Put the batteries into battery case of remote control, and then operate it.

## PANEL INSTRUCTION

### FRONT PANEL FUNCTION

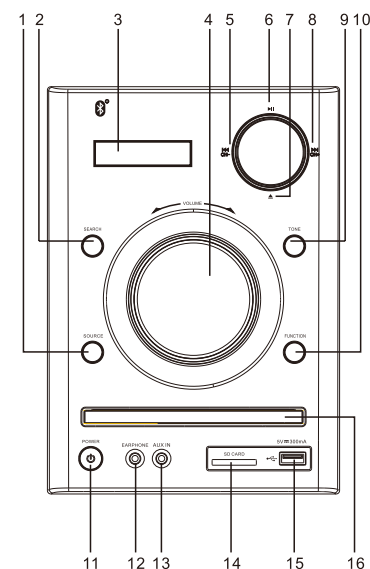

1. Source function key (switch between CD/USB/SD)
2. Search function key
3. Display screen
4. Rotary Volume knob
5. Previous and CH- function key
6. Play or Pause function key
7. Open or Close function key
8. Next and CH+ function key
9. Tone function key (Bass and Treble adjust)
10. Function switch function key (switch between CD/AUX/FM/Bluetooth)
11. Power switch function key
12. Earphone Inserting Jack
13. AUX IN
14. SD Card
15. USB Drive
16. CD Door

### REAR PANEL FUNCTION

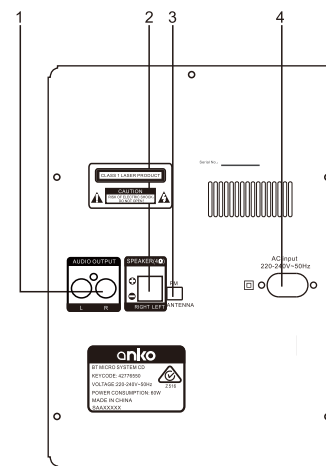

1. Audio L & R channel Output
2. Wire Clamp for Speakers
3. FM Radio Antenna Jack
4. AC Input

REMOTE CONTROL INSTRUCTION

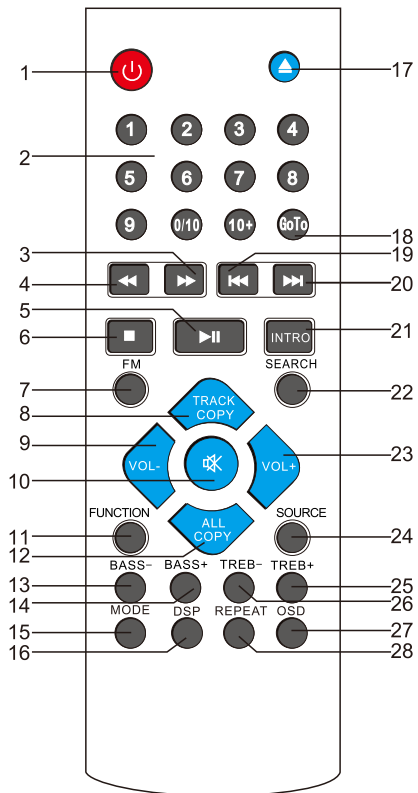

1. Power Standby Function key
2. Number Function key
3. Forward Function key
4. Reverse Function key
5. Play/Pause Function key
6. Stop Function key
7. FM Radio Function key
8. Single Track Copy Function Key
9. Volume - Function key
10. Mute Function key
11. Function Key  
(switch between CD, FM, AUX, Bluetooth mode)
12. All Tracks Copy Function
13. Bass - Function key
14. Bass + Function key
15. Channel Switch
16. Display Function key
17. Disc Chamber Function key
18. Go/To Function key(only for FM)
19. Previous Function key
20. Next Function key
21. Audition Function key
22. Radio Search Function key
23. Volume + Function key
24. SOURCE Function Key  
switch between CD / USB and SD mode
25. Treble + Function key
26. Treble - Function key
27. On-Screen Display Function key
28. Repeat Function key

**!** Caution

Use of controls or adjustments or performance of procedures other than herein may result in hazardous radiation exposure or other unsafe operation.

Always follow the instructions in this chapter in sequence.

Connect power

**!** Caution

Risk of product damage ! Ensure that the power supply voltage corresponds to the voltage printed on the back or the underside of the unit.

- Risk of electric shock ! When you unplug the AC power cord, always pull the plug from the socket. Never pull the cord.
- Before you connect the AC power cord, make sure that you have completed all other connections.

Connect the power cable to the wall socket

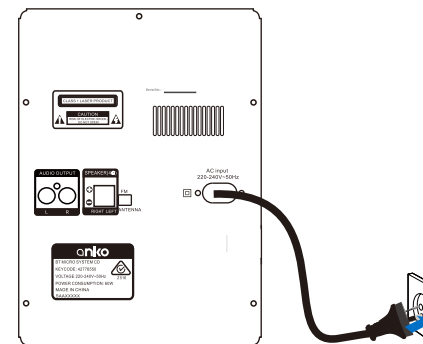

Prepare the remote control



- To insert the remote control batteries:
1. Open the battery compartment.
  2. Insert 2 x AAA batteries with correct polarity(+/-) as indicated. The 2 x AAA battery not include in our products, please purchase from Authorized Seller.
  3. Close the battery compartment.
  4. The batteries not including in the accessories of goods.

Please Note:

- If you are not going to use the remote for a long time, remove the batteries.
- Do not use old and new or different types of batteries in combination.
- Please attention should be drawn to the environmental aspects of battery disposal, as contains chemical substances, so they should be disposed of properly. Battery shall not be exposed to excessive heat such as sunshine, fire or the like.

How to Turn on the unit

1. Connect the AC power cable and plug to the wall socket;
2. Press "POWER" button on the front panel or "⏻" function on the remote control to start the player .
2. Press "POWER" button on the front panel or "⏻" function key on the remote control again to close the player.

**Caution:**  
If you do not use this player for a long time, please press "POWER" button and disconnected the AC power of this player.

## VOLUME ADJUSTMENT

Press  on the front panel or VOL-/VOL+ on the remote control to adjust volume .

## TONE SETUP

1. Bass Setup: Press BASS-/BASS+ on the remote control to turn down or up Bass (between -14 and +14)

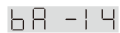

2. Treble Setup: Press TREBLE-/TREBLE+ on the remote control to turn down or up Treble (between -14 and +14).



3. Dual Mono: Press MODE on the remote control, there are three kinds of sound output to be selected: CH L, CH R and LR (stereo) .





4. DSP Setup: Press DSP on the remote control, then there are four kinds of different sound effects to be chosen.

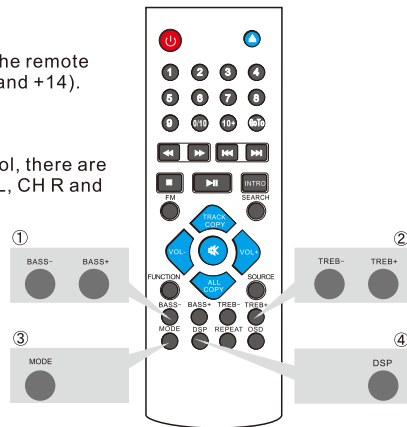



## CD PLAYER

Press "Power" button on the front panel to be energized, and press  on the front panel or  on the remote control to make the Disk tray open, then put Disc correctly, and press the  again, then play the Disc automatically after several seconds.

## PLAY PAUSE STOP

While playing, press  on the front panel or  on the remote control to stop for a while, then the Disc will be paused to play. Press  once more, the Disc resumes to play.

While playing, press  on the remote control to stop, then the Disc will be paused to play. Press  once more, the Disc restarts to play.

## PREVIOUS NEXT

While playing, press  on the front panel or on the remote control to the previous chapter played.



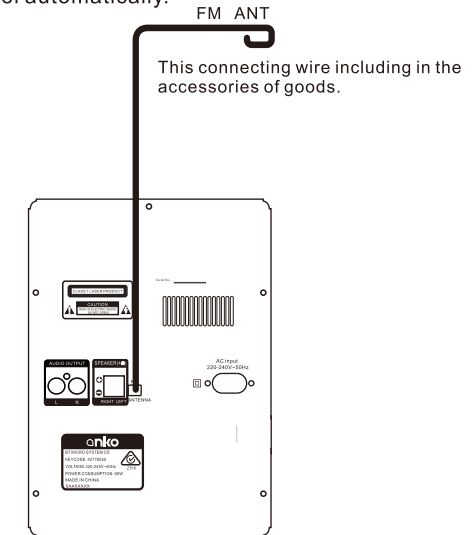

While playing, press  on the front panel or on the remote control to the next chapter.

## SETUP

When you want to listen to radio program, put the radio antenna into the antenna jack on the rear panel, and press "FUNCTION" button to switch to FM mode on the front panel or on the remote control. The CD player will turn to FM radio mode, and press SEARCH button to search radio channel automatically between 87 MHz and 108 MHz. After searching, the CD Player will save the radio channel automatically.



## BASIC OPERATION

1. When you are listening to radio program, press MODE button on the remote control, then you can swift the Channel between stereo and mono lang.
2. When you are listening to radio program, press  on the remote control to the next channel; press  on the remote control to the previous channel.
3. When you are listening to radio program, press   on the remote control to search channels up and down.

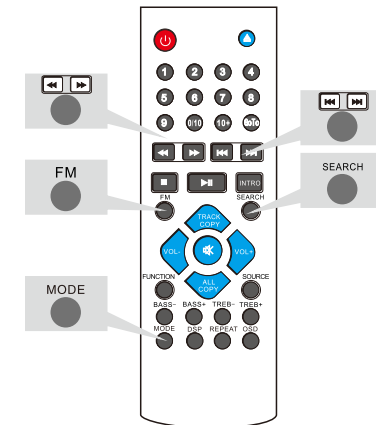

**Audio output instruction**

(Audio output function only apply for CD and USB mode.)

Use the connecting wires of left and right to connect the out terminal of this CD player and the audio input terminal of other AMP( amplifier).

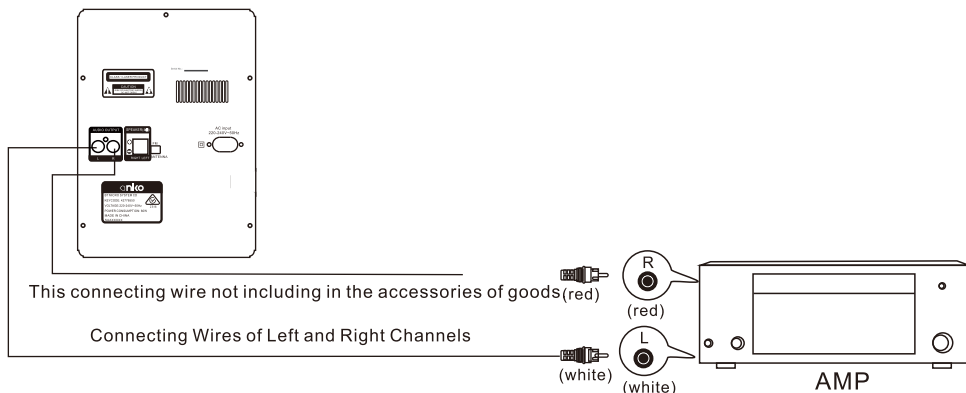

**Audio input instruction**

**Listen to external audio device**

The unit can be used as a power amplifier to play the tracks from external audio device. You can listen to an external audio device, such as MP3 player/Mobile/Computer/TV through this unit.

1. Press FUNCTION button on the front panel or press FUNCTION button on the remote control. "LINE IN" will display on the screen.
2. Connect the external device into the unit's AUX jack with line cable.
3. Play the tracks from the external audio device.

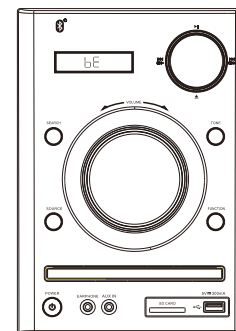
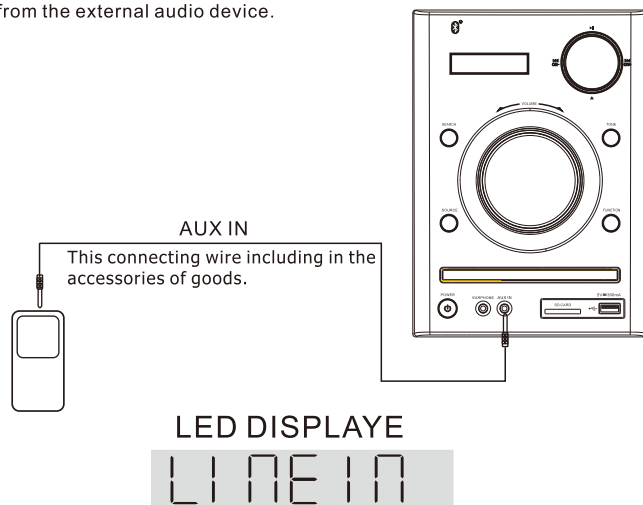

1. Press "POWER" button to turn on the player;
2. Press "FUNCTION" button on the player panel or on the remote control to switch Bluetooth mode; and " bE" display on the screen;
3. Switch on your bluetooth device and search for 42776550 and connect it.
4. Once connected successful, a small connection notification tone is heard from the player.
5. Use ◀▶ and ▶▶ button to control the tracks.

**BASIC OPERATION**

When Playing the chapters in USB , the other steps are the same as the basic operation of CD Player(please check the page 7). If you want to change CD function and USB function, please press **SOURCE KEY** on the front panel or on the remote control.

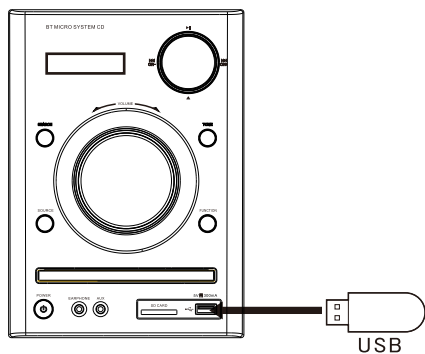

**Convert CD to MP3**

Insert a USB drive to the USB port. Press Track COPY to convert a single track or ALL COPY to record the full disc.

1. While playing a CD track , insert a USB drive to the USB port. Press Track Copy on the remote control to record a single track.
2. While playing a CD, insert a USB drive to the USB port. Press All Copy to record the full disc.

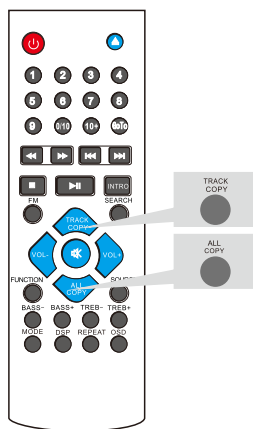

**TROUBLE SHOOTING**

Breakdown guide

Before service, please inspects the question below

Phenomenon	Cause	Measurement
No power	Disconnect the power plug	Connect the power plug right
Don't work after being energized	No Disc	Put Disc into the CD player
No sound	Not connecting to the right jack	connecting to the right jack
	Disconnect the Audio Input lines	connect the Audio Input lines
	Equipment connected doesn't work or Volume is 0	Make Equipment connected work or turn the volume up
Remote control out of order	Not aiming to the receiving window	aiming to the receiving window
	The distance between the remote control and receiving window	Operating within 7meters
	The battery of remote control run out of electricity	Replace new batteries
MP3 without sound or with noise	Disc has other modes files	Jump those files

## SPECIFICATION

### The Main Technical Parameter

Item	Parameter
Output	Frequency: 2 sound channel independent output
Disc supported	MP3
	CD
	CD-R, CD-RW
Audio characteristic	Frequency response : 20Hz - 20KHz
	Signal to noise ratio: ≥80dB
	Total harmonic distortion:<0.01%
Output power (RMS)	30W
Supply voltage	AC 220V-240V 50Hz
Measurement of CD Player (MM)	Main Unit:165x195x235 MM Speaker:145x195x230MM
Temperature	-10°C ~+45°C
Humidity	15-75%( without the waterdrop)
Accessories	Remote control, Manual, Audio Cable, FM Radio Antenna

## WARRANTY

### 12 Month Warranty

Thank you for your purchase from Kmart.

Kmart Australia Ltd warrants your new product to be free from defects in materials and workmanship for the period stated above, from the date of purchase, provided that the product is used in accordance with accompanying recommendations or instructions where provided. This warranty is in addition to your rights under the Australian Consumer Law.

Kmart will provide you with your choice of a refund, repair or exchange (where possible) for this product if it becomes defective within the warranty period. Kmart will bear the reasonable expense of claiming the warranty. This warranty will no longer apply where the defect is a result of alteration, accident, misuse, abuse or neglect.

Please retain your receipt as proof of purchase and contact our Customer Service Centre on 1800 124 125 (Australia) or 0800 945 995 (New Zealand) or alternatively, via Customer Help at [Kmart.com.au](http://Kmart.com.au) for any difficulties with your product. Warranty claims and claims for expense incurred in returning this product can be addressed to our Customer Service Centre at 690 Springvale Rd, Mulgrave Vic 3170.

Our goods come with guarantees that cannot be excluded under the Australian Consumer Law. You are entitled to a replacement or refund for a major failure and compensation for any other reasonably foreseeable loss or damage. You are also entitled to have the goods repaired or replaced if the goods fail to be of acceptable quality and the failure does not amount to a major failure.

For New Zealand customers, this warranty is in addition to statutory rights observed under New Zealand legislation.