

# Assembly Instructions

SIDE DRAWER 42902843











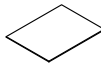





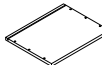

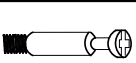

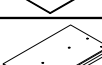

**CARE INSTRUCTIONS:**

WIPE CLEAN WITH A DAMP OR DRY CLOTH. DO NOT USE ABRASIVE MATERIALS AND SOLVENTS. KEEP AWAY FROM WATER AND DIRECT SUNLIGHT. STORE IN A DRY PLACE. FOR INDOOR USE ONLY.

**WARNING:**

DO NOT STAND OR SIT ON THIS SIDE DRAWER. DO NOT KNOCK OR DRAG THE SIDE DRAWER. THIS PACKAGE CONTAINS SMALL PARTS AND SHARP POINTS. KEEP AWAY FROM CHILDREN AND BABIES. ADULT ASSEMBLY REQUIRED. A MILD ODOUR MAY BE PRESENT WHEN FIRST OPENING THIS CARTON. SIMPLY ALLOW TO AIR OUTSIDE AND THIS WILL FADE. LOAD DRAWER EVENLY TO PREVENT FROM TIPPING OVER. **MAXIMUM SAFE LOAD: 10KGS FOR TOP PANEL, 5KGS FOR EACH DRAWER.**

Hardware List

A		2 PCS	N		1 pcs
B		2 PCS	O	 M6x25mm	4 pcs
C		1 PCS	P	 M8x30mm	6 pcs
D		1 PCS	Q	 M4x25mm	4 pcs
E		1 PCS	R		12 pcs
F		1 PCS	S		12 pcs
G		1 PCS	T	 φ6x30mm	6 pcs
H		1 PCS	U	 M4x40mm	4 pcs
I		1 PCS	V	 M4x30mm	4 pcs
J		1 PCS	W	 M4x20mm	2 pcs
K		1 PCS	X		1 PCS
L		1 PCS	Y		4 PCS
M		1 PCS	Z	 Tool	2 PCS

**ATTENTION:**  
DO NOT TIGHTEN THE SCREWS FULLY DURING ASSEMBLY.  
FULLY TIGHTEN SCREWS AFTER THE FINAL ASSEMBLY STEP.

Step:1

Dx1 Fx1 Gx1 Hx1 Jx1 Sx12 Tx6

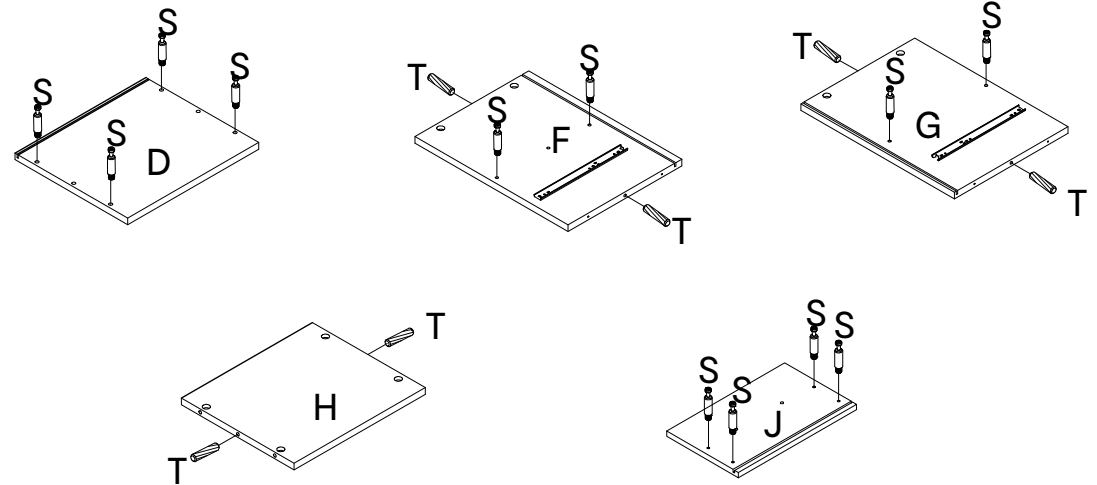

Step:2

Rx4

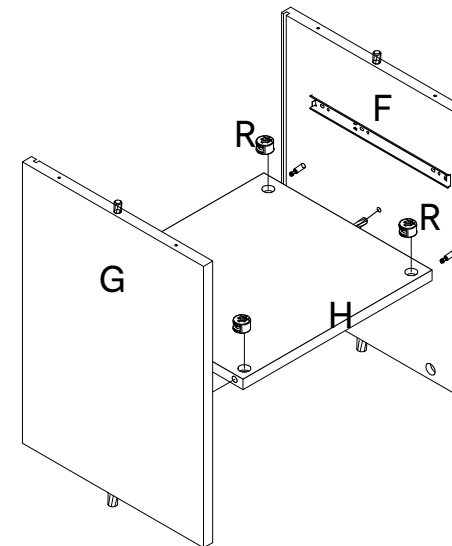

Step:3

Ix1 Rx4

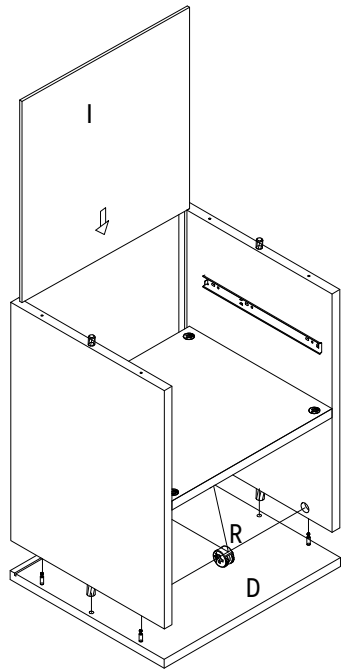

Step:5

Ax2 Bx2 Cx1  
Px6 Yx4

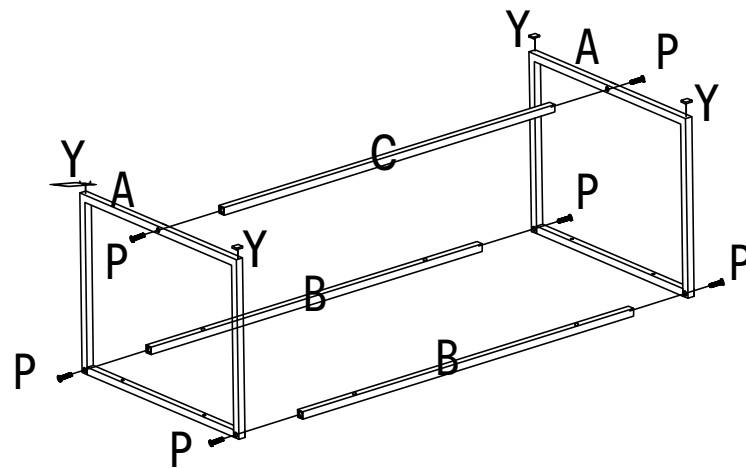

Step:4

Ex1 Ux4

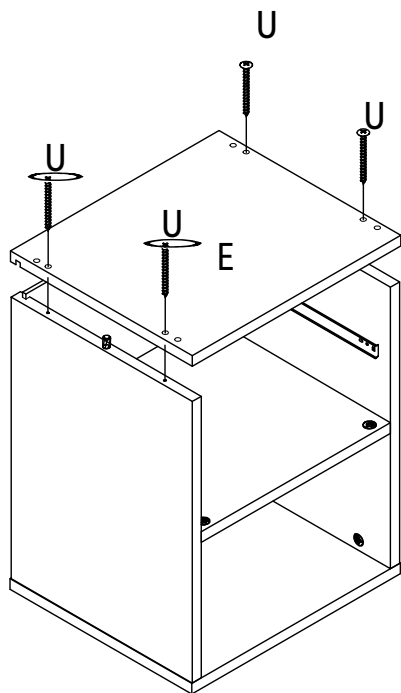

Step:6

Ox4 Qx4

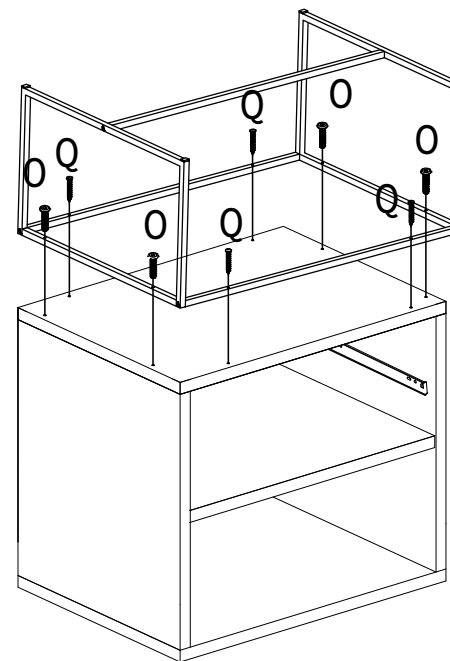

### Step:7

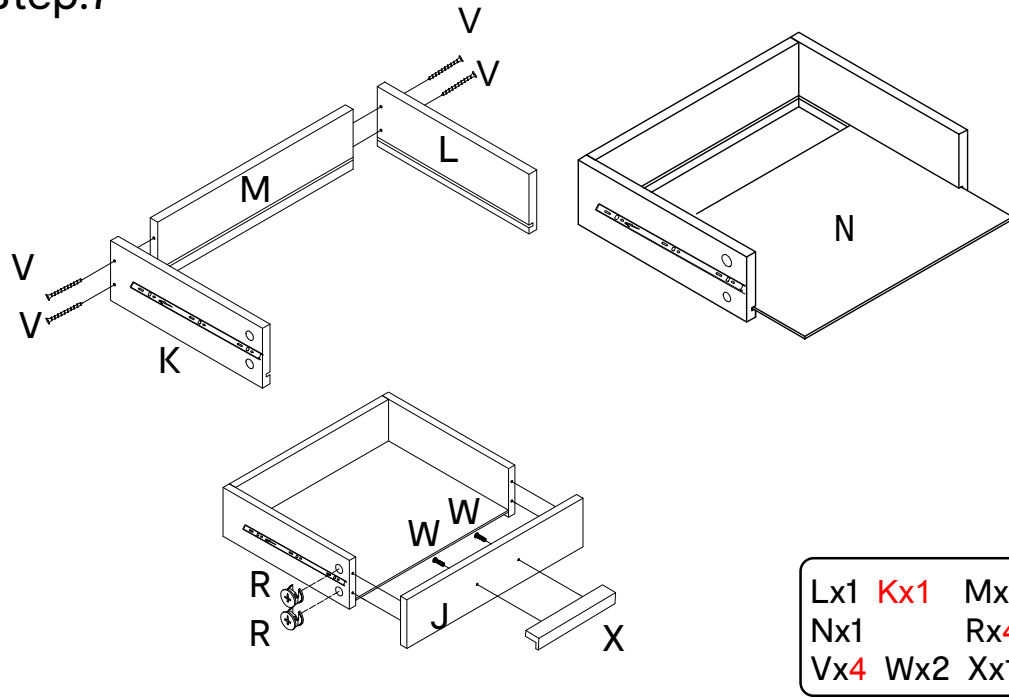

### Step:9

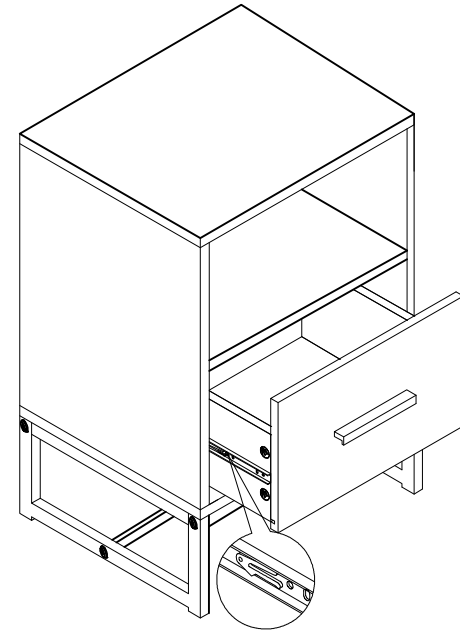

### Step:8

