

User Guide

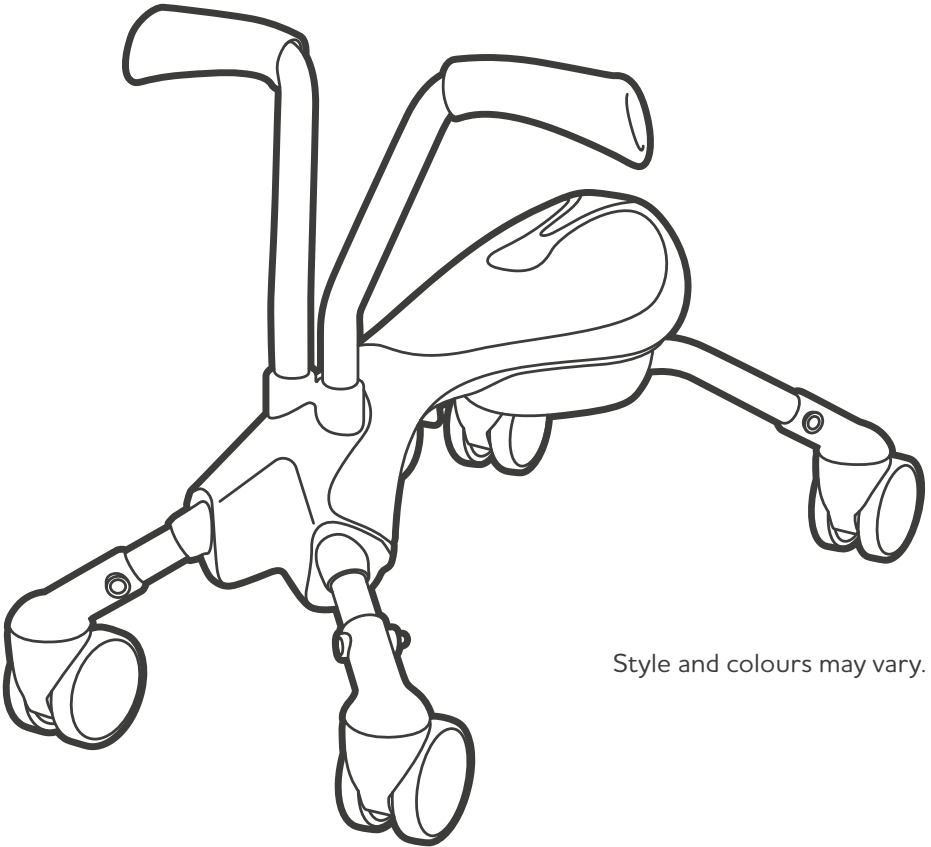

Style and colours may vary.



Contains small parts required for assembly.

Mookie

www.mookie.co.uk

ASSEMBLY

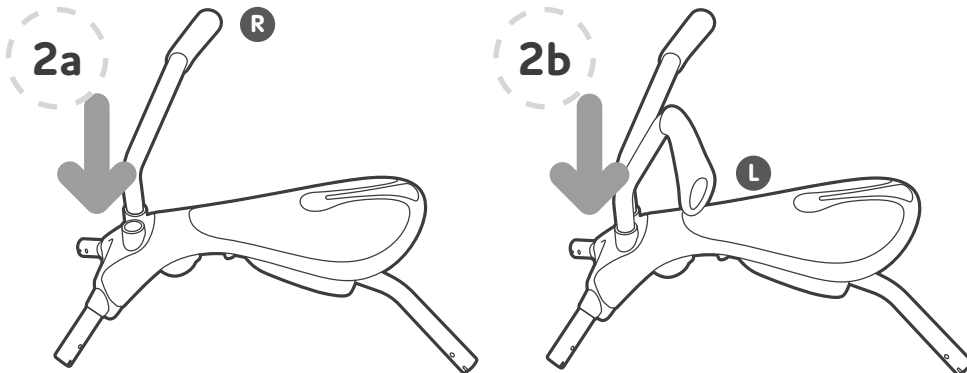
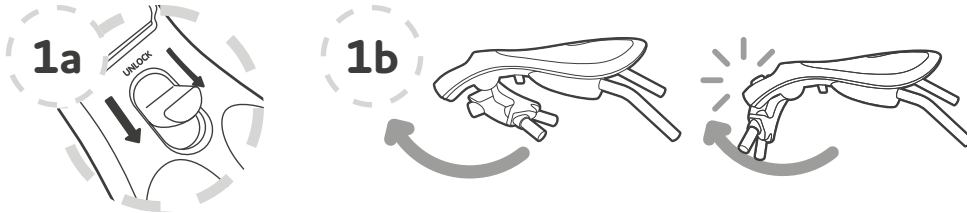
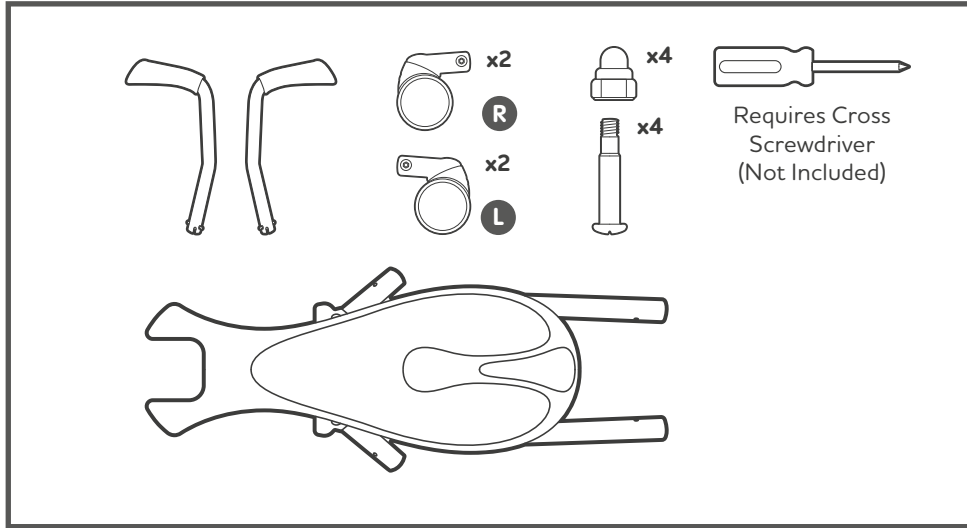

3

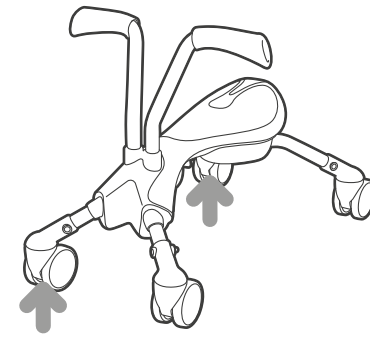

x2 **R**

3a

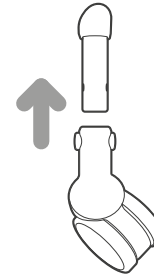

3b

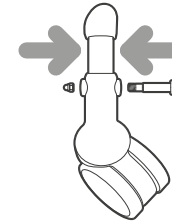

3c

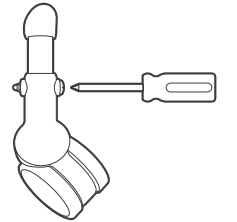

4

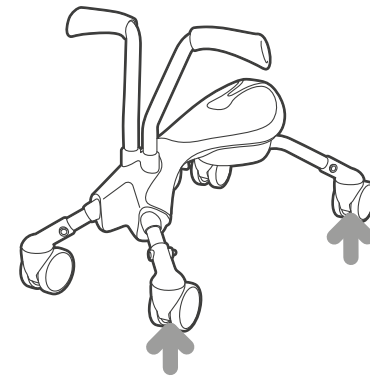

x2 **L**

4a

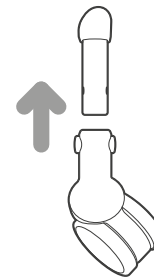

4b

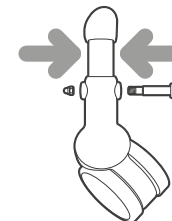

4c

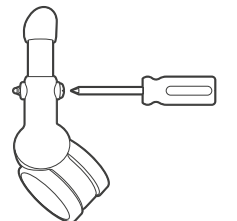

UNFOLDING

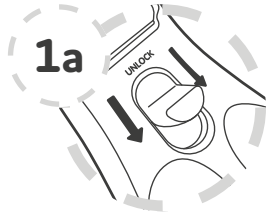

1a

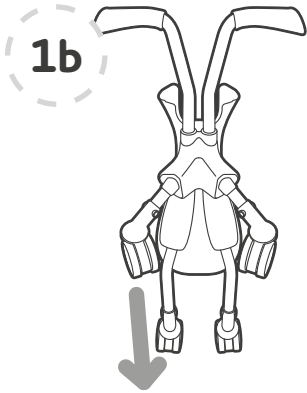

1b

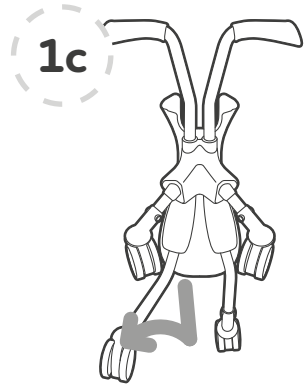

1c

x2

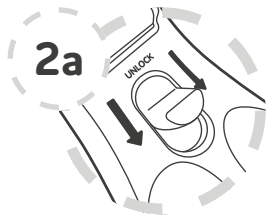

2a

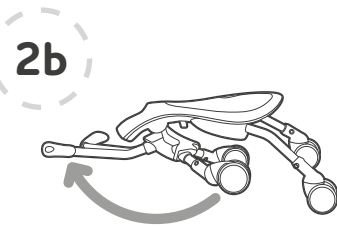

2b

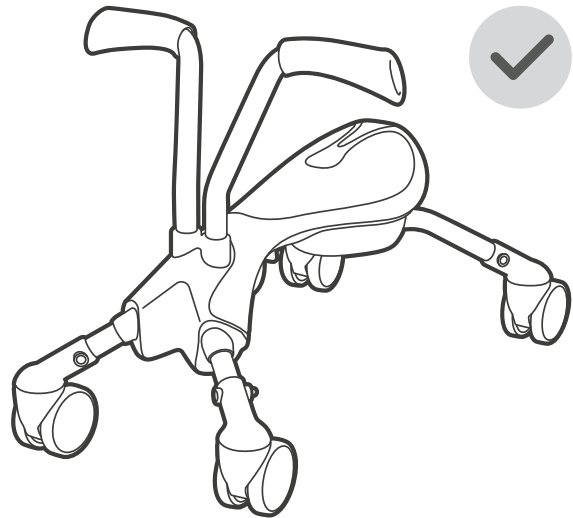
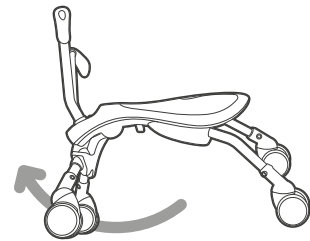

FOLDING

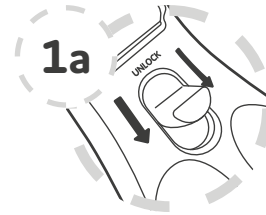

1a

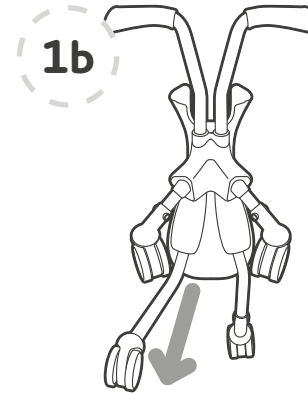

1b

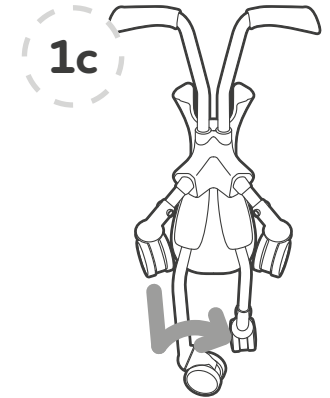

1c

x2

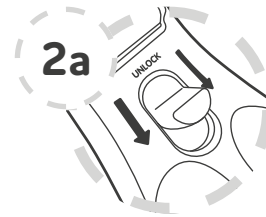

2a

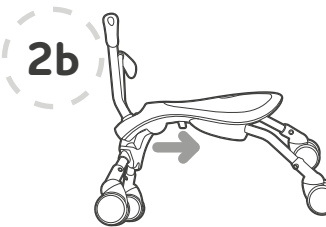

2b

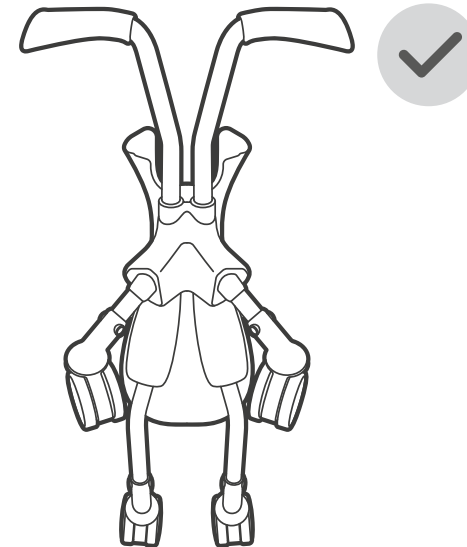
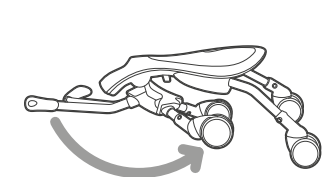

One Year Limited Warranty

Mookie Toys warrants this product to the original retail purchaser as follows:

This product is warranted against defective materials or workmanship for one year from the date of original purchase. An original receipt is required to validate your warranty.

To the extent permitted by law, Mookie Toys will, as its option, provide replacement parts or replace this product. Mookie Toys reserves the right to substitute if the part or model has been discontinued.

To make a claim under this warranty you may contact your distributor as indicated on the box. Proof of purchase is required.

Our goods come with guarantees that cannot be excluded under the Australian Consumer Law. You are entitled to replacement or refund for a major failure and compensation for any other reasonably foreseeable loss or damage. You are also entitled to have goods repaired or replaced if the goods fail to be acceptable quality and the failure does not amount to a major failure.

For New Zealand customers, this warranty is in addition to statutory rights observed under New Zealand legislation.

Warranty Limitations

This warranty does not include damages which arise from misuse or abuse of this product. This one year warranty is in addition to consumer protection conditions and warranties implied by Australian and European laws.

The logo for Mookie Toys, featuring the word "Mookie" in a bold, white, rounded font with a thick black outline, set against a black background.

Mookie, Flitwick, Bedfordshire, MK45 5BX, U.K.

Please email: help@mookie.co.uk

or contact our helpline on +(44)(0)1525 722769 (9am-5pm Mon-Fri)

Made in China. © Mookie 2017

ANKO

MADE IN CHINA

42911104

15/20

FOR AU / NZ: IMPORTED FOR KMART
STORES IN AUSTRALIA AND NEW ZEALAND.

FOR USA: IMPORTED BY ANKO RETAIL INC.
19500 ALDERWOOD MALL PARKWAY
LYNNWOOD WA 98036 USA.

www.mookie.co.uk

