

Instruction Manual



Keycode:42928836

Multifunction Sewing machine

- ※ Please read the instruction book carefully before operating the sewing machine.
- ※ Please save this manual in a safe place.
- ※ This sewing machine is for Household Use.

APPLICABLE CLOTH FOR SEWING

Sewing Presentation Fabric Specification	Cloth	Cotton/Linen	Silk/Wool	Polyster	Elastic
	Regular	✓	✗	✓	△
Thick	✓	✗	✓	△	
Thin	✓	✗	✗	✗	
Hard	✓	✓	✓	△	
Soft	✗	✗	✗	✗	

Sewing effective:

- ✓ : means easy to sew
- ✗ : means difficult to sew
- △ : means not smooth to sew

Note:

1. The definition of the fabric thickness:

Thin(fabric) : two layers of the fabric thickness<0.014inch,
 Thick(fabric) : two layers of the fabric thickness>0.031inch;
 Regular(fabric) : two layers of the fabric thickness≥0.014inch and ≤0.031inch.

2. The definition of elastic cloth :

If the cloth,which size is "3.94inch x 1.18inch",is extending to or over 4.17inch under 1.1LBS tension force,Then the cloth is defined elastic,otherwise it is inelastic.

3. **Hard fabric** : such as jeans,fine canvas,etc.

4. **Soft fabric** : such as towel,duster,etc.

Please read all instructions before using this appliance and keep the instructions for future reference.





IMPORTANT SAFETY INSTRUCTIONS

- ✗ This sewing machine is for domestic use only.
- ✗ Do not use outdoors
- ✗ Powered by an AC/DC adaptor
- ✗ The sewing machine must be switched off with the adaptor unplugged when :
 - Threading the needle
 - Changing the needle
 - Changing bottom bobbin
 - Changing parts
 - Cleaning the machine
 - After each use

CAUTIONS

- Never leave the sewing machine unattended in the presence of children.
- When operating the sewing machine, keep your hands away from the needle, hand wheel, upper thread tension dial and pattern selection dial.
- To clean the sewing machine, simply wipe it with a soft cloth and never use any harsh chemical solutions.

ACCESSORIES

Foot pedal	×1	
Thread spool	×2	
Bobbin	×2	
Needle threader	×1	
Needle (#14)	×1	
adaptor	×1	

NAME OF PARTS

Front view

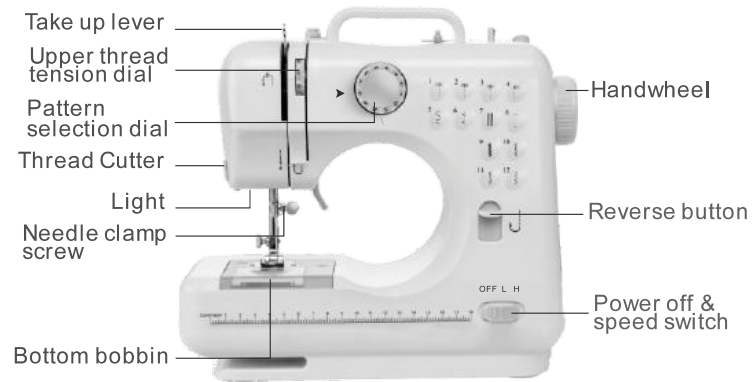

Back view

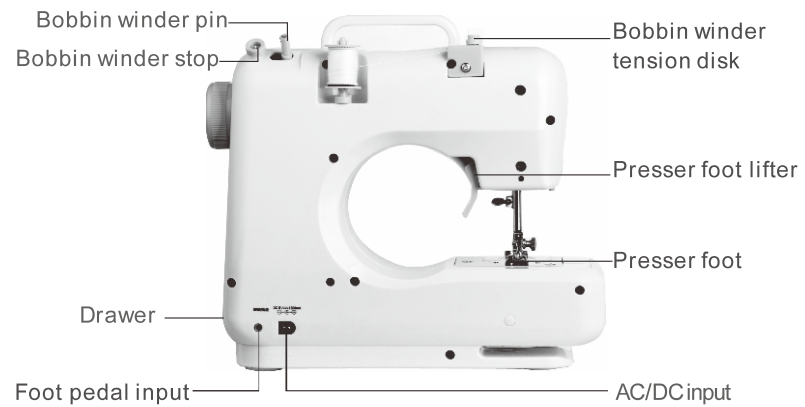

FEATURE ADJUSTING STITCHING

1. As shown in the picture (Fig. A), normal stitching shall have top and bottom threading evenly, neither over tight nor loose.

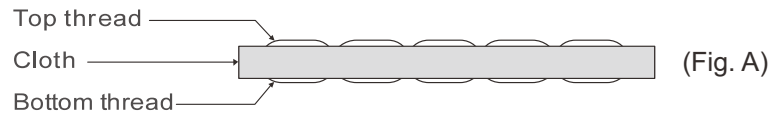

2. If the bottom thread looks like a straight line, which indicates the top thread is too loose, please turn the tension dial neither too tight nor too loose counterclockwise (to higher numbers) to increase the pressure until the stitch returns to normal. (Fig. B)

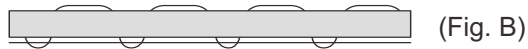

3. However, when the top thread looks like a straight line indicating an over-tight top thread, slowly turn the upper thread tension dial clockwise (to lower numbers) to reduce pressure until the stitch back to normal. (Fig. C)



SEWING A BUTTONHOLE MANUALLY

- (1) Put the cloth under the presser foot and lower the presser foot on the cloth where you need to sew buttonhole, then choose the stitch pattern #8.
- (2) Turn on the switch and sew 5-6 stitch in low speed, then turn off the switch (Fig. 17).
- (3) Choose the stitch pattern #7, turn on switch and sew on the cloth in suitable length, then turn off switch. Note that try to keep sewed stitch in straight line (Fig. 18).
- (4) Choose the stitch pattern #8, then turn on switch and sew 5-6 stitch in low speed, then turn off switch (Fig. 19).
- (5) Raise the presser foot, rotating the cloth for 180° (Fig. 20).
- (6) Choose the stitch pattern #7, then turn on switch and sew till buttonhole is fully sewed (Fig. 21).

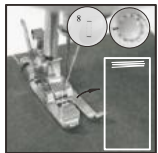

(Fig. 17)

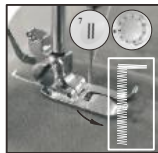

(Fig.18)

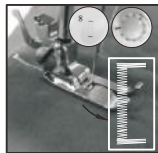

(Fig. 19)



(Fig. 20)



(Fig. 21)

CONNECTING THE SEWING MACHINE TO THE MAINS POWER SUPPLY

1. Make sure the “power OFF/ L & H speed switch” is on the “OFF” position.
2. Connect the jack position A to the DC input socket on the back of the sewing machine, and connect the three-pin plug position B into the main power supply.
3. Connect the foot pedal position C to the sewing machine by inserting the jack into the foot pedal input socket on the back of the sewing machine.
4. You can either use the foot pedal (please keep the power/speed switch on the off position) or the power/speed switch (H setting for high sewing speed whilst the L stand for low sewing speed) to operate the sewing machine.

CAUTION:

Whenever the sewing machine is not in use, make sure it is switched off and unplugged from the mains power supply.



INSTALLING THE BATTERIES

1. Make sure the “power OFF/ L & H speed switch” is on the “OFF” position.
2. Turn the sewing machine over on a flat surface and remove the battery compartment cover.
3. Insert 4xAA batteries into the compartment and replace the battery cover.

CAUTION 1:

To prevent accidental start up of the sewing machine, always make sure that the “power OFF/ L & H speed switch” is on the “OFF” position when inserting, or changing the batteries.



CAUTION 2:

The adaptor and batteries cannot be used at the same time, otherwise will cause the damage on machine. Please take out the batteries when using adaptor.

THREADING THE SEWING MACHINE

Threading upper thread

CAUTION : When threading the sewing machine make sure that the “power OFF/ L & H speed switch” is on the “OFF” position and follow the steps 1-6 below.

Turn hand wheel counter clockwise until the needle is in the highest position.

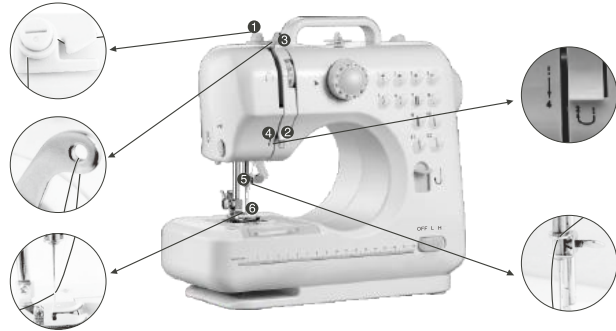

NEEDLE REPLACEMENT

CAUTION: Remove the batteries and/or disconnect the AC/DC adaptor before starting to replace the needle.

1. Turn the hand wheel to raise the needle to its highest position.
2. Hold the old needles and loosen the needle clamp screw. Remove the old needle and discard responsibly.
3. Insert the new needle into the clamp with the flat side toward the back. Be sure to push the needle clamp before tightening the needle clamp screw.
4. Tighten the needle clamp screw.



(Fig.1)

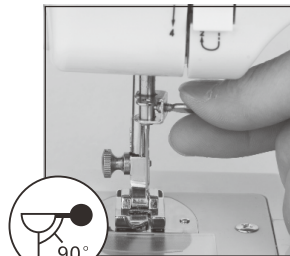

(Fig.2)

DRAWER

on the side of the sewing machine (towards the rear) is a drawer for the handy storage of accessories.



WINDING THE BOBBIN

- (1) Put a spool of thread on spool pin (Fig.11).
- (2) Guide the thread through the bobbin winder tension disk on the upper side of the machine (Fig.12)
- (3) Put the bobbin on the bobbin winder pin, wind thread clockwise around bobbin several times (Fig.13).
- (4) Push bobbin to the left (Fig.14).
- (5) Switch on the machine to start winding (Fig.15).
- (6) Switch off the machine to stop winding after appropriate volume of thread you wanted had wound on bobbin.
- (7) Push bobbin away from bobbin winder stop, take bobbin off the pin and cut the thread (Fig.16).

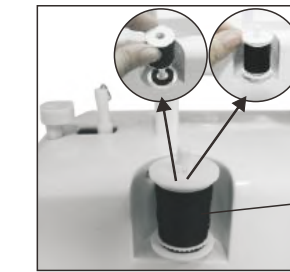

(Fig.11)

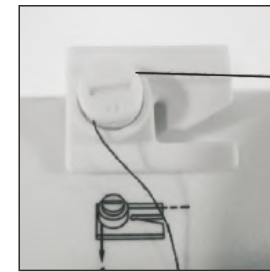

(Fig.12)

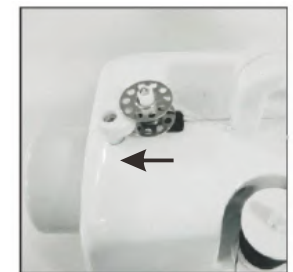

(Fig.13)

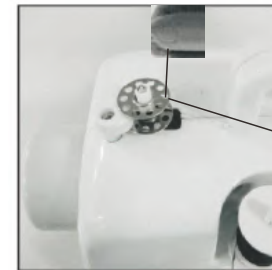

(Fig.14)

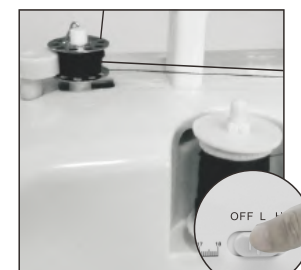

(Fig.15)



(Fig.16)

FEATURES

12 STITCH PATTERNS

1. The sewing machine has a choice of 12 different stitch patterns. To select the stitch you require, look at the diagrams numbered 1-12 on the front of the sewing machine, choose the corresponding number on the dial which is lined up with the arrow. For example, to select zigzag stitch (diagram number 6), simply turn the selector dial until the number 6 on the dial is lined up with the arrow.)
2. When you wish to change a stitch pattern turn the hand wheel on the side of the sewing machine to raise the needle to the highest point and set the pattern selection dial to the desired stitch type in the same way as above.



REVERSE STITCH BUTTON

Reverse sewing (back stitching) is useful for reinforcing the beginning and end of seams. To use this function proceed as follows:

1. Sew forwards as normal, and then press and hold down the reverse stitch button on the front of the sewing machine to sew backwards.
2. To sew forwards again simply release the reverse stitch button.

SETTING THE SEWING SPEED

This sewing machine has two sewing speeds. Push the 'OFF' button, into the right, to the 'H' position and the sewing speed will be increased, while on the 'L' position will reduce the speed.



WORK LIGHT

If additional light is needed, press the light switch to turn the light 'On'. Press the switch again to turn it 'Off'.



THREAD CUTTER

It has a thread cutter on the central left side of the machine, it can cut off the thread after sewing or winding thread.

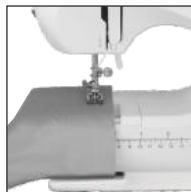

SEWING SLEEVES

This sewing machine has been designed to sew sleeves or any narrow openings in garment.

1. Lift the presser foot.
2. Position the garment over the sewing arm.
3. Lower the presser foot and follow the regular sewing instructions.

REPLACING THE BOBBIN

1. Turn the hand wheel counter clockwise until the needle is in the highest position. Raise presser foot lifter.
2. Slide the bobbin cover button to the right and remove the bobbin cover (Fig.3).
3. Put the new bobbin in the holder, with thread going clockwise. leave 10 cm of thread hanging out (Fig.4).
4. Hold the end of the upper thread with one hand, and turn the hand wheel counterclockwise with the other hand. the needle thread will pick up the bobbin thread and pull it up through the hole under the needle (Fig.5).
5. Replace the bobbin cover and separate the two threads and pull them to the back of the machine under the presser foot, leaving about 15 cm hanging there. Replace the bobbin cover (Fig.6).

! CAUTION:

1. Always switch off the appliance, disconnect from the power supply and remove foot pedal when replacing bottom bobbin.
2. Please use metal bobbins, otherwise the magnetic holder cannot tense the bobbin thread and work rightly.



(Fig. 3)



(Fig. 4)



(Fig. 5)



(Fig. 6)

PRESSER FOOT REPLACEMENT

1. Removing the presser foot :

Turn the hand wheel counterclockwise to raise the needle to its highest position (Fig. A). Raise the presser foot lifter, and press the presser foot locking lever. The presser foot will drop off automatically from the locking device (Fig. B).

2. Installing the presser foot :

Put the presser foot under the presser foot locking device, and lower the presser foot lifter (Fig. C), press the presser foot locking lever to reinstall the foot. Raise the presser foot lifter (Fig. D).

! CAUTION:

1. Please always switch power off, disconnecting the machine from the power adaptor and remove the foot pedal before replacing the presser foot.
2. When replace the presser foot, please the machine on a stable platform.
3. When you put down the presser, please keep your hand or fingers away from the bottom side of the presser foot to avoid injuring your fingers.

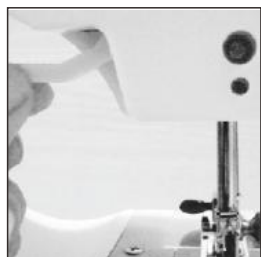

(Fig. A)

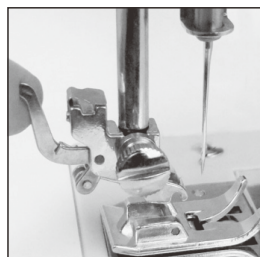

(Fig. B)

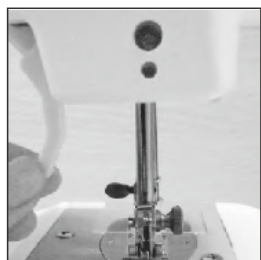

(Fig. C)



(Fig. D)

SEWING

1. Turn the hand wheel counterclockwise to raise the needle to its highest position.
2. Raise the presser foot lifter and place the fabric you want to sew under the presser foot (Fig. 7).
3. Lower the presser foot (Fig. 8).
4. Rotate the pattern selection dial to select the stitch pattern you wanted.

! CAUTION :

- ※ Before you change the stitch pattern, please turn off the switch and turn the hand wheel to raise the needle all the way up so it doesn't get stuck and bent.
 - ※ Changing the stitch pattern is not allowed when the machine is running ; otherwise, the needle and/or machine may damage.
5. Turn the hand wheel counterclockwise several times to make sure there is no jamming in the stitches.
 6. Slide the power switch to the Low or High speed position, and the machine will automatically start sewing. We recommend the low speed for beginners (Fig. 9).
 7. When you finished the sewing, turn off the switch, unplug the adaptor, turn the hand wheel to raise the needle all the way up, lift the presser foot, and then gently remove the fabric from the sewing machine, and cut the thread with the thread cutter (Fig. 10).

USAGE TIPS :

please turn the hand wheel if it is difficult to remove the fabric, and then pull out the fabric gently.

if the thread had tangled or jammed, please turn the hand wheel and simultaneously pull the thread slightly to release the thread. Bottom bobbin mechanism is a more precise part , inappropriate actions may damage it, please do not push or pull it by finger or any tools.

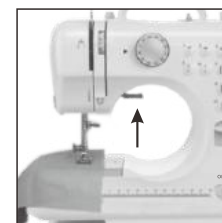

(Fig. 7)

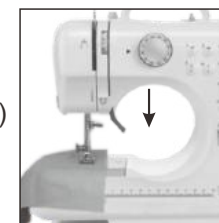

(Fig. 8)

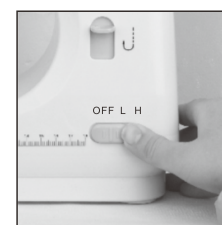

(Fig. 9)

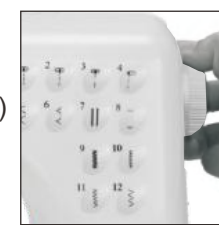

(Fig. 10)