

Assembly Instructions

42942245 QB Rattan Bedhead





CARE INSTRUCTION:

Wipe clean with a dry cloth. Do not use abrasive materials and solvents. Check and tighten all parts regularly. Keep away from water and direct sunlight. For indoor and domestic use.

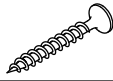

WARNINGS:

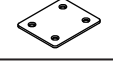
Do not stand on the bedhead surface. Do not use until all screws, bolts and knobs are firmly secured. This product contains small parts and sharp points, keep away from children and babies. Adult assembly required. Failure to follow these warnings could result in serious injury.

Hardware list

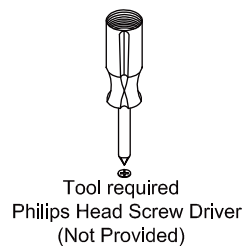
	A	M4X35mm	12 PCS
	B	M6X30mm	4 PCS
	C	M3.5X16mm	8 PCS
	D	60X50mm	2 PCS
	E	M4mm	1 PC

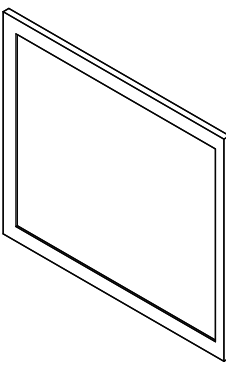
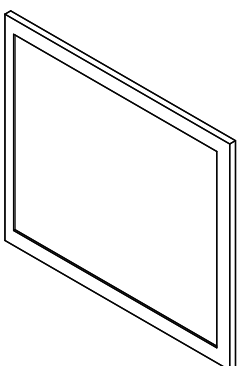

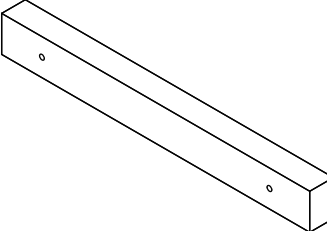
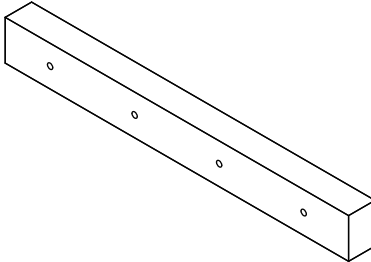
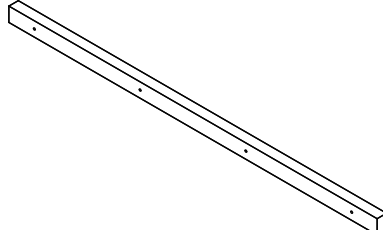
	1	1 PC		2	1 PC		3	2 PCS
	4	2 PCS		5	1 PC		6	1 PC

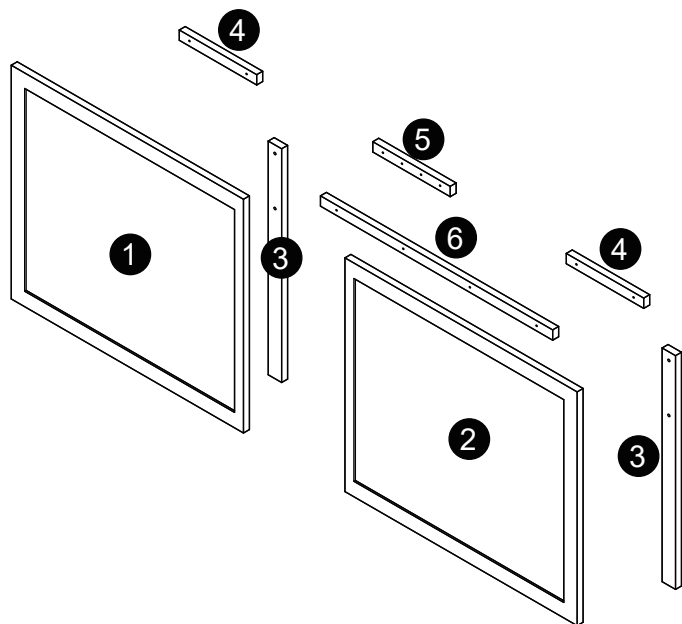

Do not tighten the screws fully during assembly.
Fully tighten screws after the final assembly steps.

STEP 1

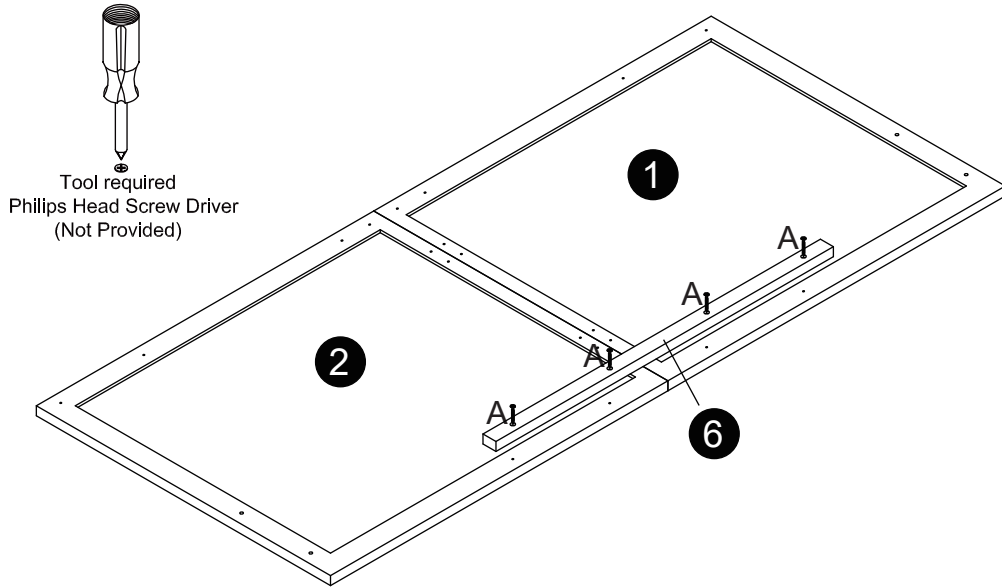
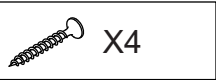

Tool required
Philips Head Screw Driver
(Not Provided)

STEP 2

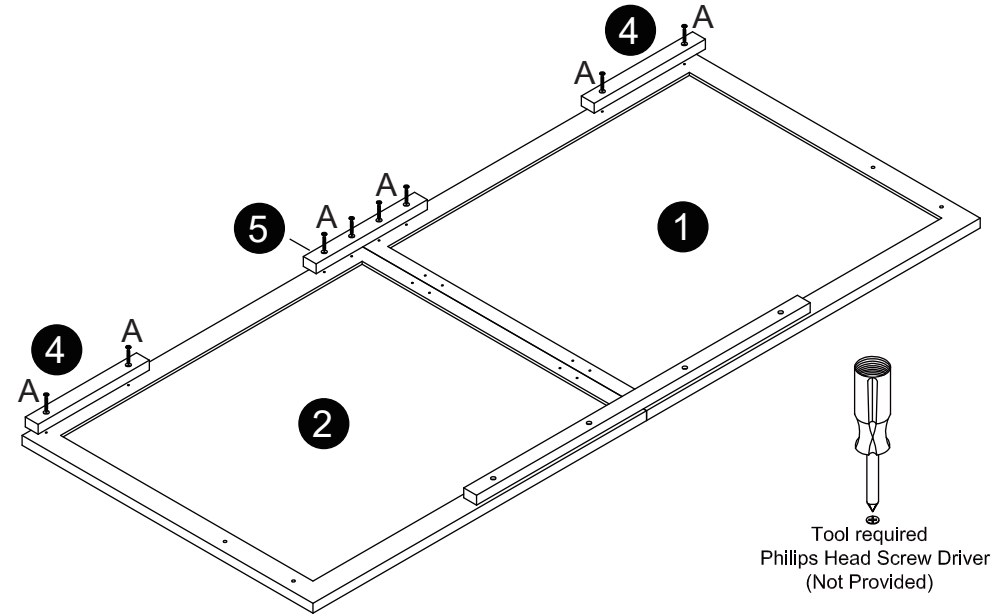

Tool required
Philips Head Screw Driver
(Not Provided)

STEP 3

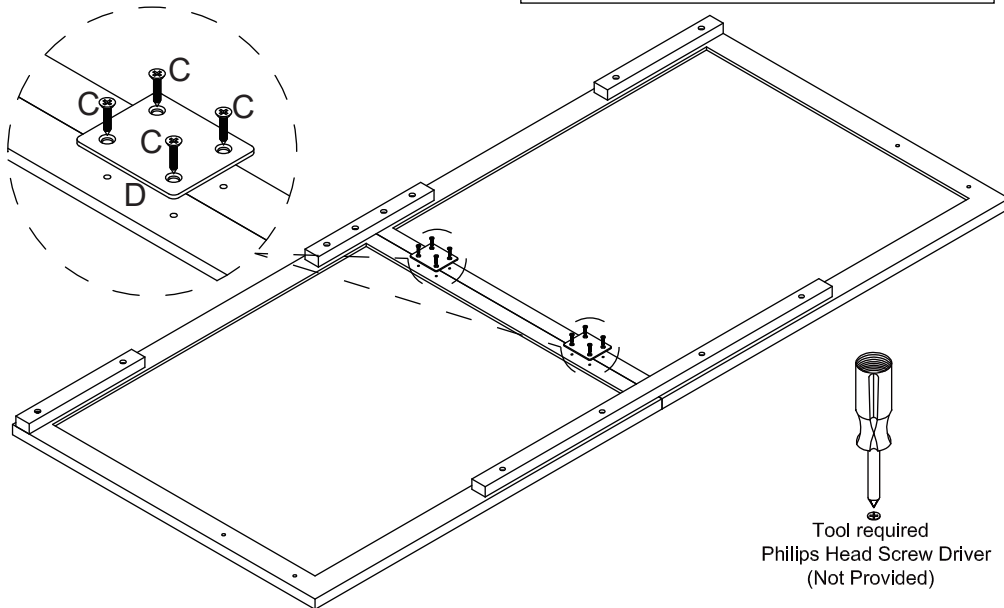

Tool required
Philips Head Screw Driver
(Not Provided)

STEP 4

