

Assembly Instructions

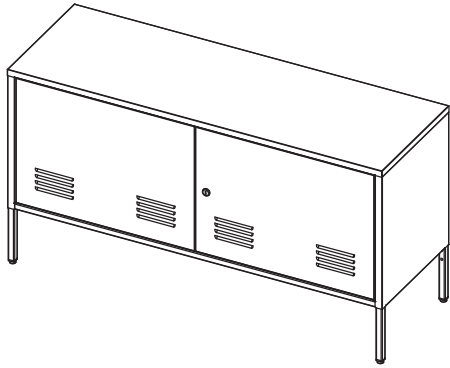

A:Side Panel×2 	B:L Back panel×1 	C:R Back panel×1 	D:Front Beam×1 	E:Back Beam×1 	F:Top panel×1 	G:Middle divided panel×1 	H:L Bottom panel×1 	I:R Bottom panel×1 	
J:Shelf×2 	K:L door panel×1 	L:R door panel×1 	N×4 	M×1 	O×9 	P×8 	Q×2 	R×2 	S×2

Step 1

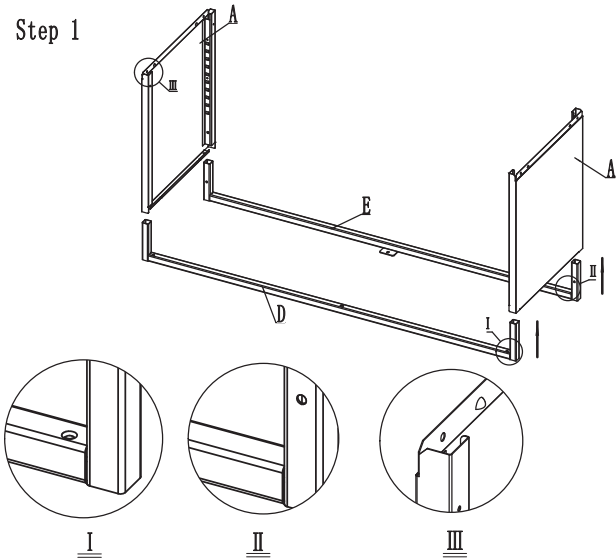

Step 2

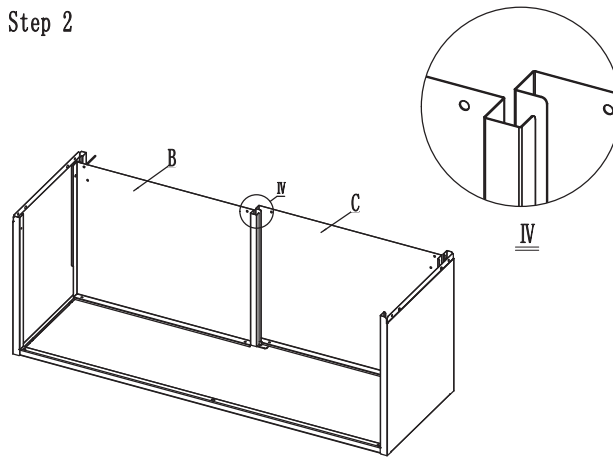

Step 3

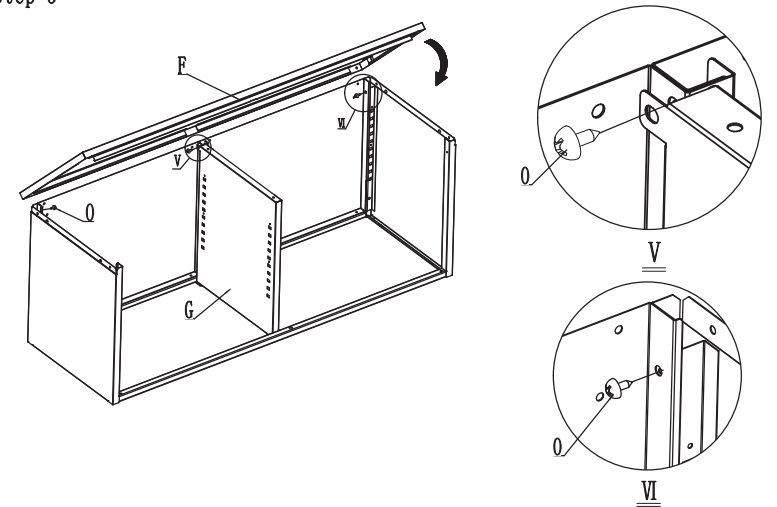

Step 4

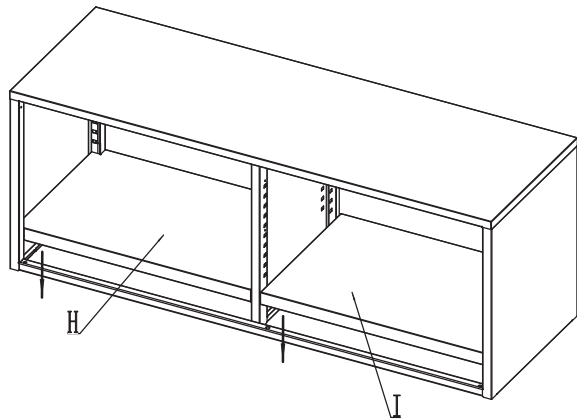

Step 5

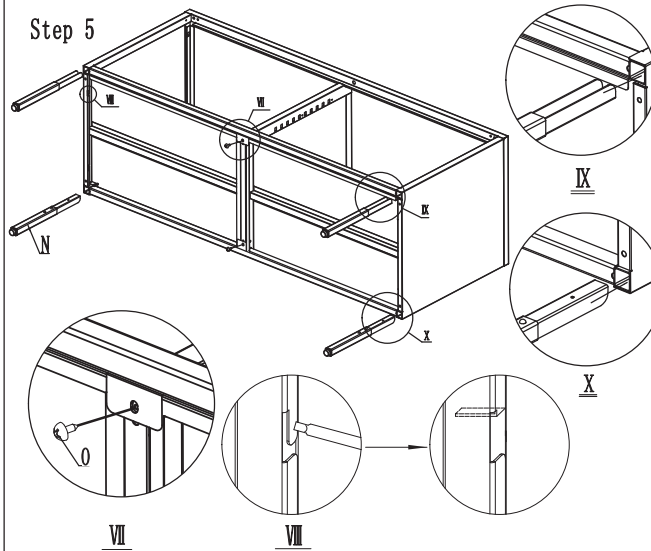

Step 6

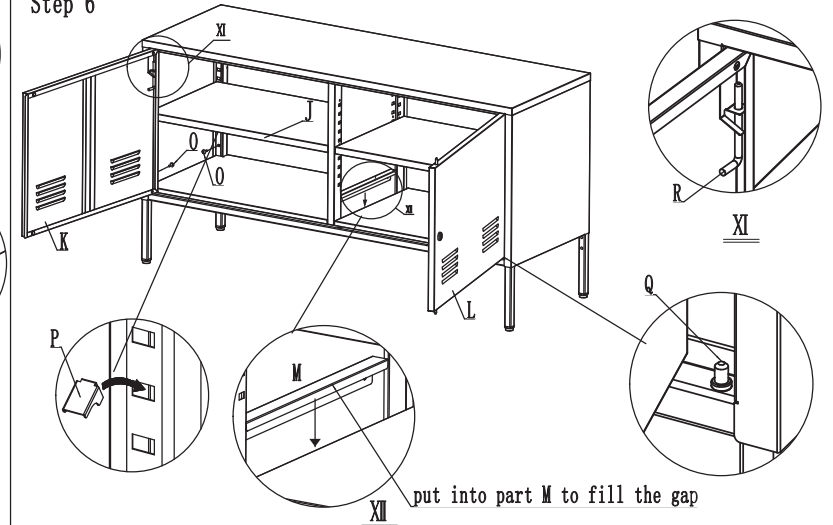

CARE INSTRUCTIONS:

Ensure you have all parts before assembling. Put all part on soft surface such as a carpet when assembling. Wipe clean with a soft dry or damp cloth. Keep away from water and direct sunlight. For indoor and domestic use. Check and tighten all parts regularly.

WARNINGS:

Do not stand or sit on the unit. Do not lean on the product. Do not drag the product. Use only on a flat surface. Do not use until all screws, bolts and knobs are firmly secured. This product contains small parts and sharp points, keep away from children and babies. Adult assembly required. Failure to follow these warnings could result in serious injury.

Max loading weight: 15kg each shelf.20kg for top panel.

It is strongly recommended that this product is permanently fixed to the wall. Please seek professional advice if you are in doubt of what fixing device to use.

Regularly check that anchors are securely maintained.

CAUTION: for your safety when attaching the anchor fixings, please note the following:

Check any electrical wires or plumbing inside the wall before drilling any holes
(if you are unsure please seek professional advice from a qualified tradesperson).

