



CD+G KARAOKE SYSTEM AND BLUETOOTH



**MODEL: KN355BTB
USER MANUAL**

**USB FLASH
DRIVE**

Bluetooth®

**PLEASE READ THIS USER MANUAL COMPLETELY BEFORE OPERATING
THIS UNIT AND RETAIN THIS BOOKLET FOR FUTURE REFERENCE.**

For further information on this model and the entire lineup of Karaoke Night products, please visit www.karaokeus.com

WARNING

TO PREVENT FIRE OR SHOCK HAZARD, DO NOT USE THIS PLUG WITH AN EXTENSION CORD, RECEPTACLE OR OTHER OUTLET UNLESS THE BLADES CAN BE FULLY INSERTED TO PREVENT BLADE EXPOSURE. TO PREVENT FIRE OR SHOCK HAZARD, DO NOT EXPOSE THIS APPLIANCE TO RAIN OR MOISTURE.



The Caution Marking is located at the back enclosure of the apparatus.
The Rating plate is located at the back enclosure of the apparatus.

IMPORTANT SAFETY INSTRUCTIONS

1. Read these instructions.
2. Keep these instructions.
3. Heed all warnings.
4. Follow all instructions.
5. Do not use this apparatus near water.
6. Clean only with dry cloth.
7. Do not block any ventilation openings. Install in accordance with the manufacturer's instructions.
8. Do not install near any heat sources such as radiators, heat registers, stoves, or other apparatus (including amplifiers) that product heat.
9. AC adapter is used as disconnect device and it should remain readily operable during intended use. In order to disconnect the apparatus from the mains completely, the AC adapter should be disconnected from the mains socket outlet completely.
10. Only use attachments/accessories specified by the manufacturer.
11. Use only with a cart, stand, tripod, bracket, or table recommended by the manufacturer, or sold with the product. When a cart is used, use caution when moving the cart/apparatus combination to avoid injury from tip-over.
12. Unplug this apparatus during lightning storms or when unused for a long periods of time.
13. Refer all servicing to qualified service personnel. Servicing is required when the apparatus has been damaged in any way, such as power-supply cord or plug is damaged, liquid has been spilled or objects have fallen into the apparatus, the apparatus has been exposed to rain or moisture, does not operate normally, or has been dropped.
14. This appliance shall not be exposed to dripping or splashing water and that no object filled with liquids such as vases shall be placed on the apparatus.
15. Do not overload wall outlet. Use only power source as indicated.
16. Use replacement part as specified by the manufacturer.

17. Upon completion of any service or repairs to this product, ask the service technician to perform safety checks.
18. Power Sources - This product should be operated only from the type of power source indicated on the marking label. If you are not sure of the type of power supply to your home, consult your product dealer or local power company. For products intended to operate from battery power, or other sources, refer to the operating instruction.
19. Object and Liquid Entry - Never push objects of any kind into this product through openings as they may touch dangerous voltage points or short-out parts that could result in a fire or electric shock. Never spill liquid of any kind on the product.
20. Damage Requiring Service - Unplug this product from the wall outlet and refer servicing to qualified service personnel under the following conditions:
 - a) When the power-supply cord or plug is damaged,
 - b) If liquid has been spilled, or objects have fallen into the product,
 - c) If the product has been exposed to rain or water,
 - d) If the product does not operate normally by following the operating instructions. Adjust only those controls that are covered by the operating instructions as an improper adjustment of other controls may result in damage and will often require extensive work by a qualified technician to restore the product to its normal operation.
 - e) If the product has been dropped or damaged in any way, and
 - f) When the product exhibits a distinct change in performance - this indicates a need for service.
21. Excessive sound pressure from earphones and headphone can cause hearing loss.
22. Minimum distances of 10 cm around the apparatus for sufficient ventilation.
23. The ventilation should not be impeded by covering the ventilation openings with items, such as newspapers, table-cloths, curtains, etc.
24. No naked flame sources, such as lighted candles, should be placed on the apparatus.
25. The use of apparatus in moderate climates.

CAUTION

CLASS 1 LASER PRODUCT

CLASS 1 LASER PRODUCT
APPAREIL À LASER DE CLASSE 1
PRODUCTO LÁSER DE CLASE 1

CAUTION
INVISIBLE LASER RADIATION
WHEN OPEN AND INTERLOCKS
DEFEATED.
AVOID EXPOSURE TO BEAM.



This product contains a low power laser device.

Follow the advice below for safe operations.

ON PROTECTION AGAINST LASER ENERGY EXPOSURE

- As the laser beam used in this compact disc player is harmful to the eyes, do not attempt to disassemble the casing.
- Stop operation immediately if any liquid or solid object should fall into the cabinet.
- Do not touch the lens or poke at it. If you do, you may damage the lens and the player may not operate properly.
- Do not put anything in the safety slot. If you do, the laser diode will be ON when the CD door is still open.

- If the unit is not to be used for a long period of time, make sure that all power sources are disconnected from the unit. Remove all batteries from the battery compartment, and unplug the AC adapter from the wall outlet. Make it a practice to remove the AC adapter by grasping the plug and not by pulling the cord.
- This unit employs a laser. The use of controls or adjustment or performance of procedures other than those specified here may result in exposure to hazardous radiation.

ON SAFETY

- Before use, check that the rated voltage of your unit matches your local voltage.
- When you are not going to use the unit for a long period of time, disconnect the AC adapter.

ON CONDENSATION

- When left in a heated room where it is warm and damp, water droplets or condensation may form inside the CD player.
- When there is condensation inside the unit, the unit may not function normally.
- If condensation occurs, let unit stand for 1 to 2 hours before turning the power on, or gradually heat the room up and dry the unit before use.
- Ensure a minimum distance of 2 inches (5 cm) around the apparatus for sufficient ventilation.
- Ensure that the ventilation is not impeded by covering the ventilation openings with items, such as newspapers, table cloths, curtains, etc.
- Do not place naked flame sources, such as lighted candles on the apparatus.
- Take attention to the environmental aspects of battery disposal.
- Use the apparatus only in moderate climates.
- Do not expose the apparatus to dripping or splashing.
- Do not place objects filled with liquids, such as vases, on the apparatus.
- Battery should not be exposed to excessive heat such as sunshine, fire or the like.
- The mains plug of apparatus should not be obstructed and should be easily accessed during intended use.

Should any trouble occur, disconnect the AC Adapter and refer servicing to qualified personnel.

DEAR KARAOKE NIGHT CUSTOMER

Selecting fine audio equipment such as the unit you've just purchased is only the start of your musical enjoyment. Now it's time to consider how you can maximize the fun and excitement your equipment offers. This manufacturer and the Electronic Industries Association's Consumer Electronics Group want you to get the most out of your equipment by playing it at a safe level. One that lets the sound come through loud and clear without annoying blaring or distortion and, most importantly, without affecting your sensitive hearing. Sound can be deceiving. Over time your hearing "comfort level" adapts to higher volumes of sound. So what sounds "normal" can actually be loud and harmful to your hearing. Guard against this by setting your equipment at a safe level BEFORE your hearing adapts.

To establish a safe level:

- Start your volume control at a low setting.
- Slowly increase the sound until you can hear it comfortably and clearly, and without distortion.

Once you have established a comfortable sound level:

- Set the dial and leave it there.

Taking a minute to do this now will help to prevent hearing damage or loss in the future. After all, we want you listening for a lifetime.

We Want You Listening For a Lifetime

Used wisely, your new sound equipment will provide a lifetime of fun and enjoyment. Since hearing damage from loud noise is often undetectable until it is too late, this manufacturer and the Electronic Industries Association's Consumer Electronics Group recommend you avoid prolonged exposure to excessive noise.



Customer's Record:

The serial number for this product is found on the back of the unit. You should note the serial number of this unit in the space provided as a permanent record of your purchase to aid in identification in the event of theft or loss.

Model Number: KN355BTB

Serial Number : _____

CONTENTS OF YOUR PRODUCT

KN355BTB CD+G Karaoke System	x 1 set
A/V Cable (1.2m / 4 feet)	x 1 pc
Aux In Cable (1m / 3.28 feet)	x 1 pc
Microphone with Cable (3m / 10 feet)	x 2 pcs
AC Adapter (DC 12V--- 1.5A output)	x 1 pc
User Manual	x 1 pc
CD+G Demo Disc	x 1 pc

PROTECT YOUR FURNITURE!!

This system is equipped with non-skid rubber 'feet' to prevent the product from moving when you operate the controls. These 'feet' are made from non-migrating rubber material specially formulated to avoid leaving any marks or stains on your furniture. However certain types of oil based furniture polishes, wood preservatives, or cleaning sprays may cause the rubber 'feet' to soften, and leave marks or a rubber residue on the furniture. To prevent any damage to your furniture we strongly recommend that you purchase small self-adhesive felt pads, available at hardware stores and home improvement centers everywhere, and apply these pads to the bottom of the rubber 'feet' before you place the product on fine wooden furniture.

INTRODUCTION

This Karaoke System has a compact design and is full of features yet it is easy to use. Just a few simple instructions and you will become an expert.

Before using your unit, please glance through this manual to familiarize yourself with all the features available and the sections of the manual that describe their operations. Next go to the section for the specific operation you wish to perform.

For your easy reference, listed here are some of the main features of this Karaoke System.

Monitor – allows you to see the graphics/lyrics while playing CD+G discs or MP3+G songs stored in your USB thumb drives.

Lyrics on Built-in Monitor or External TV Screen - display the lyrics with the tempo of music when playing CD+G discs or MP3+G songs.

Automatic Voice Control - lets you replace the original singer's voice with your own voice when any pre-recorded multiplex karaoke disc is played. To activate, just rotate the Mic Volume to a comfortable listening level and Auto Voice Control for the best balance between playback and microphone levels.

Balance Control - lets you adjust the balance between the pre-recorded original singer's voice and the music if you use a multiplex karaoke disc.

Echo Control - lets you add an echo to enrich your voice for a concert hall effect.

Built-in Speaker - lets you share the music with your family or friends.

Audio Out Jacks - lets you connect another audio output component, such as an equalizer/-booster or a PA system.

Video Out Jack - lets you connect to your external TV for displaying the lyrics.

Digital Key Control – makes it easier to sing at your desired pitch.

Light Show – Exciting LED disco style light show on the speaker grill.

USB Port – Lets you connect your USB thumb drive for playing MP3 audio and MP3+G.

LOCATION OF CONTROLS

FRONT PANEL

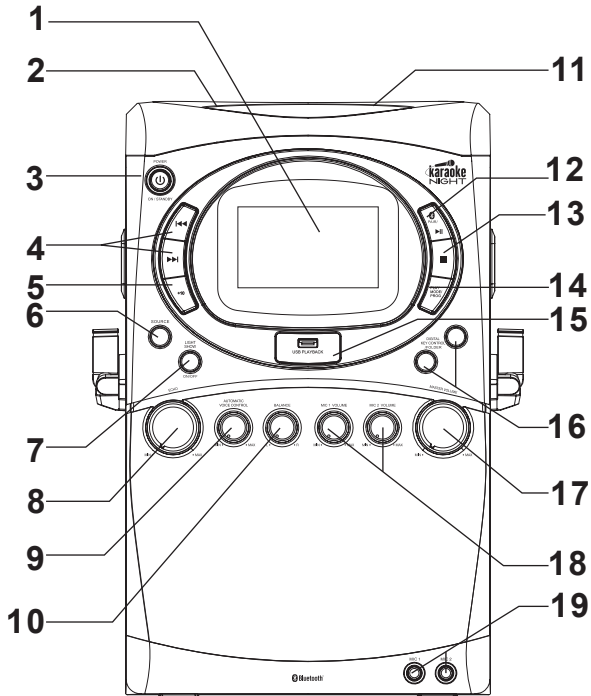

1. BUILT-IN TFT COLOR MONITOR
2. CD DOOR
3. POWER ON/STANDBY BUTTON WITH INDICATOR
4. **⏮ / ⏭** SKIP BUTTONS
5. +10 TRACK BUTTON
6. SOURCE BUTTON
7. LIGHT SHOW BUTTON
8. ECHO KNOB
9. AVC KNOB
10. BALANCE KNOB

11. CD DOOR LATCH
12. BLUETOOTH PAIR  BUTTON;
PLAY/PAUSE **▶||**
13. STOP **■** BUTTON
14. PLAY MODE/PROGRAM BUTTON
15. USB PORT
16. DIGITAL KEY CONTROLS/
FOLDER UP (+)/DOWN (-) BUTTONS
17. MASTER VOLUME CONTROL
18. MIC 1 / MIC 2 VOLUME CONTROLS
19. MIC 1 / MIC 2 INPUT JACKS

REAR PANEL

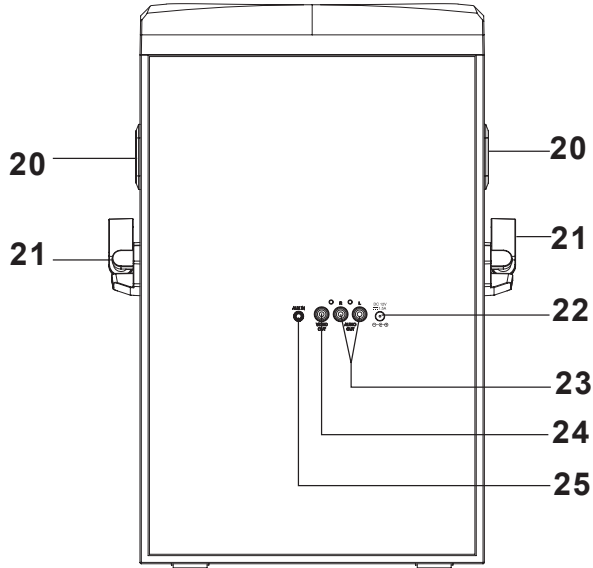

- 20. CARRYING HANDLE
- 21. MICROPHONE HOLDERS
- 22. DC JACK DC12V ---
- 23. AUDIO OUTPUT JACKS (WHITE CODED FOR LEFT, RED CODED FOR RIGHT)
- 24. VIDEO OUTPUT JACK (YELLOW CODED)
- 25. AUX-IN JACK (3.5mm)

MONITOR MESSAGE

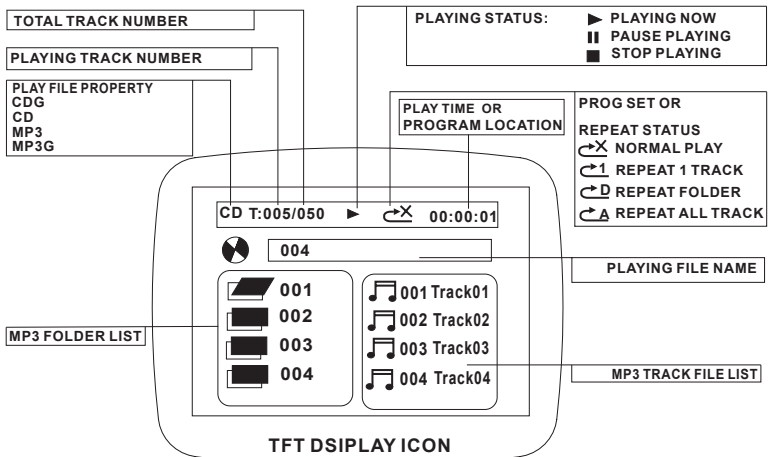

POWER SOURCES

AC OPERATION

Plug the supplied AC adapter into the DC jack (12V DC input) on the rear panel of the unit and connect to a standard AC wall socket. Press the POWER ON/STANDBY button on the Karaoke system to turn on and the POWER INDICATOR will light.

Note: When the unit is not operated for long periods of time, unplug the AC adapter from the unit and wall outlet.



CONNECTING TO AN EXTERNAL TV/MONITOR

The karaoke system provides a patch cord to give you the option of connecting your unit to an external audio/video device. The patch cord has three RCA plugs at each end. White and Red are for left and right audio connections and the Yellow is for video. Modern flat panel digital TV sets and home music systems are usually equipped with corresponding color-coded RCA jacks to assist correct connections. Make sure that you have a CD+G disc in the karaoke system playing when you are making this connection. You will know you have the proper settings on your TV as soon as you see the lyrics on the screen.

Video connection

Please follow these steps to display CD+G or MP3+G lyrics on an external TV screen:

1. Locate the color-coded patch cords.
2. Connect video cable (Yellow) to the VIDEO OUT on the back of the karaoke system.
3. Connect the other end of the video cable (Yellow) to the VIDEO / A/V INPUT on your TV.
4. Turn on both units and start playing CD+G disc or MP3+G stored in your USB thumb drive.

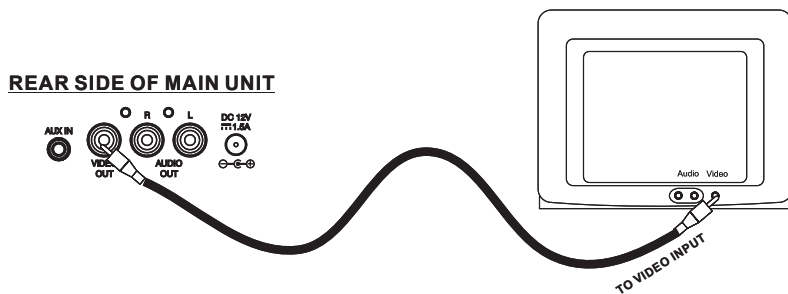

CONNECTING AUDIO TO TV OR HOME STEREO

Connect the unit to your TV or home stereo system using the White and Red connections on the supplied patch cord. Plug the white end of the patch cord into the white AUDIO OUT jack on the unit. Plug the red end of the patch cord into the red AUDIO OUT jack on the unit. Now connect the other end of the cable's white (left channel) and red (right channel) plugs to your TV or home stereo system's 'AUDIO INPUT', 'LINE IN' or 'AUX IN' jacks. After connecting, you should be able to play music from a CD/CD-R/CD-RW/CD+G disc through the connected TV or home stereo system.

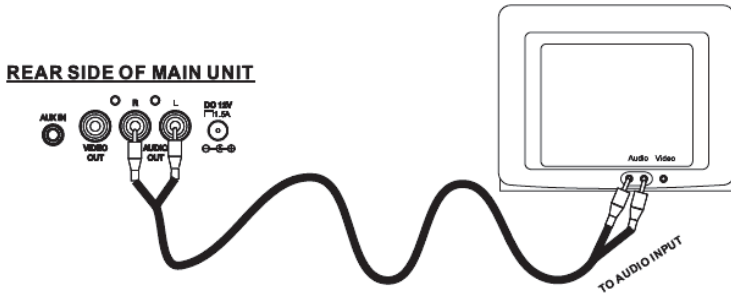

USING AUX IN FUNCTION

This feature allows you to listen to an external audio source through the speaker of this unit.

1. Plug a 3.5mm audio cable (included) into the headphone jack of your external audio player (not included) and connect the other end (3.5mm plug) into the AUX IN jack on the rear side of this unit.
2. Make sure both units are turned on. Tap the SOURCE button of KN355BTB repeatedly to select AUX mode, AUX IN message will show in TFT color monitor.
3. Play a song on your external audio player.
4. Adjust the volume control of your audio player and then the MASTER VOLUME CONTROL of the unit to obtain the desired audio sound level.
5. Turn off both the external audio player and this unit after use. Unplug the audio cable from AUX IN jack.

EXAMPLE OF EXTERNAL AUDIO PLAYER



CONNECTING THE MICROPHONE

WARNING - Tapping or dropping the microphone while it is on can permanently damage your microphone. Do not swing the microphone around by the cord.

Note: To prevent feedback or whistling from occurring, please be sure that the microphone is not too close to unit's speaker.

FRONT SIDE LOWER OF MAIN UNIT

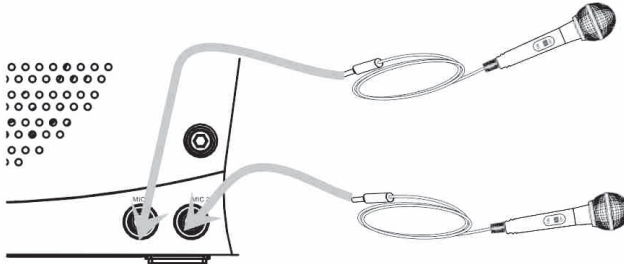

1. Connect the supplied Microphone to either one of the MIC input jacks.
2. Press the POWER ON/STANDBY button to turn on the Karaoke system, the POWER INDICATOR will light.
3. Slide the ON/OFF switch located on the Microphone to the ON position and speak or sing into the Microphone. The Microphone sensitivity and loudness can be adjusted as required by turning the corresponding MIC VOLUME control and/or MASTER VOLUME control.
4. Turn off the unit after use by pressing the POWER ON/STANDBY button again. The POWER INDICATOR will be dim.

INSTALLING AND REMOVING A DISC

Make sure nothing is connected to the AUX IN JACK and press the POWER ON/STANDBY button to power up the unit. Pull on the CD DOOR LATCH to open. Hold the CD by the edges with label side facing up and mount it horizontally into the CD compartment. Press the CD DOOR to close.

Notes:

- Do not press or open the CD DOOR while it is playing.
- Do not apply excessive force to the CD DOOR.
- Never place anything except a compact disc in the CD compartment. Foreign objects can damage the unit.
- Mount only one disc into the CD compartment at a time.

CD/CD+G/MP3 DISC OPERATION

ABOUT CD-R/CD-RW DISCS

PLEASE READ THIS IMPORTANT INFORMATION:

CD mechanisms used in devices like this are designed to fully read all commercial CDs. They will also read self-compiled CD-RWs but it may take up to 10 seconds for playback to start. If playback does not start, it is likely due to the quality of the CD-R/RW disc and/or the compatibility of the CD compilation software. Manufacturer is not responsible for the playback quality of CD-R/RW discs.

Do not attach a label or seal to either side of the CD-R/RW disc. It may cause a malfunction.

Note: This unit is designed to play CDs bearing these identification logos.

If CDs do not conform to the CD or CD+G standard, they may not play properly.



LOADING A DISC

1. Tap the POWER ON/STANDBY button to turn on the unit. The power indicator will be bright and the built-in monitor will be on.
If the color TFT monitor shows unit in other mode, tap the SOURCE button repeatedly to change to CD mode.
2. Grip the "OPEN" mark on the CD Door and pull gently to open it.
3. Load a disc into the compartment with the printed side facing upward.
4. Gently close the CD DOOR. The karaoke system begins to read the disc. The TFT color monitor will briefly show "Disc Reading" message and then total number of tracks.
5. Tap the ►|| PLAY/PAUSE button to play disc. (If no disc is recognized, "No Disc" will be displayed).

PLAY/PAUSE MODE

1. To start playing, tap the ►|| PLAY/PAUSE button once, the first track "01" will be displayed and the PLAY indicator "►" will show in the monitor.
2. To temporarily stop playing, press the ►|| PLAY/PAUSE button, the PAUSE indicator "||" will show in the monitor.
3. To resume play, press the ►|| PLAY/PAUSE button again.
4. Use the MASTER VOLUME knob to increase or decrease the speaker sound.

Notes:

- If a CD+G disc is detected, the CDG indicator will appear briefly and then the lyrics will appear in the built-in TFT color MONITOR.
- If desired, connect the A/V cable to an external TV monitor or home stereo system instead (TV and/or home stereo system are not included).

STOP MODE

If the STOP button ■ is pressed in the course of playing, the disc will cease to play. The total number of tracks & time will be shown on the TFT color monitor.





SKIP/SEARCH

1. In stop mode, you can skip up or down to a specific track number by pressing the ◀◀ / ▶▶ SKIP buttons.
2. While the selected track is reached, press the ►|| PLAY/PAUSE button to play.
3. During the PLAY mode, you can skip down or up to a specific track number by pressing the ◀◀ / ▶▶ SKIP buttons respectively.

4. [For CD and MP3 disc only] When music is playing, press and hold the ⏮ / ⏭ SKIP buttons to fast-forward or fast-rewind search through the current track.
- **Folder searching (for MP3 disc only)**
In MP3 disc stop mode, press the FOLDER UP (+) or FOLDER DOWN (-) button to skip to next / previous folder.
 - **+10 track searching**
Press the +10 track button to search by advance 10 track per step if the track is far away from menu selection.

CD/CD+G/MP3 DISC REPEAT OPERATION

In CD / CD+G / MP3 disc playing mode,

1. To repeat the current track, press the PLAY MODE button once. The REPEAT 1 indicator  will show in the monitor. The track will continue to play until the repeat function is turned off.
2. To repeat folder playing (for MP3 disc only), press the PLAY MODE button twice, the REPEAT FOLDER indicator  will show in the monitor. The tracks of selected folder on the disc will be played repeatedly.
3. To repeat all the tracks, repeatedly press the PLAY MODE button until the REPEAT ALL indicator  show in the monitor. All the tracks on the disc will be played repeatedly.
4. To clear the repeat function, press the PLAY MODE button again. The REPEAT OFF indicator  will show in the monitor.

CD/CD+G/MP3 DISC PROGRAM OPERATION

In CD, CD+G or MP3 disc stop mode, use the PLAY MODE/PROGRAM button to program and play back songs in a pre-selected order.

Note: Programming can be done in the stop mode only.

1. Press the PROGRAM (PROG) button. The PROGRAM SET mode “PROG SET 01: 01” will show in the monitor, last two digits of track number indicator are flashing to prompt for input.
2. Press the ⏮ / ⏭ SKIP buttons forward or back to select a desired track number. Press the +10 track button if the track is far away from menu selection. If folder selection is required, press the FOLDER+ (UP) or FOLDER- (DOWN) button to skip to next or previous folder.

Notes: Folder selection for MP3 disc only.

3. Press PROGRAM button to confirm entry. Program counter advance to “02” and flashing with programmed track number again.
4. You can repeat the steps 2 & 3 up to a maximum of 20 tracks. When maximum of 20 tracks have been programmed, “PROG FULL” message appears briefly in the monitor and then “PROG” mode icon shows in the monitor steadily.
5. Press ►|| PLAY/PAUSE button when you have completed programming to start playing. You are now ready to start singing along.
6. Press STOP button twice or open the CD COMPARTMENT COVER to clear all the programmed entries.

USING MICROPHONES/ECHO/BALANCE/AVC/DIGITAL KEY CONTROL

- **MICROPHONE** : When either one or two Microphones are plugged into the MIC 1 jack / MIC 2 jack, their output is mixed with the playback from CD/CD+G/MP3 discs or MP3/MP3+G songs from USB thumb drive.
- **MIC VOLUME**: Adjust corresponding MIC VOLUME knob for best balance between playback and microphone (singing) levels.
- **ECHO** : Adjust ECHO to add depth and richness to vocals.
- **BALANCE** : Adjust BALANCE for balance between the pre-recorded singer's voice and the music if you are using a multiplex karaoke disc.
- **AVC** : Press the AVC (Automatic Voice Control) button to ON if you want the original singer's voice to stop while you are singing. The original singer's voice will resume immediately when you pause your singing.
- **DIGITAL KEY CONTROL**: Adjust accordingly to be able to sing at your desired pitch.

USB OPERATION

The system is able to decode and playback all MP3 OR MP3+G files which are stored in the memory media of your USB thumb drive.

Note: If music stored in your USB thumb drive does not conform to the MP3 or MP3+G standard, they may not play properly.

1. Plug-in the USB plug with the face up & make sure it is inserted completely.
Note: Connecting the USB upside down or backwards could damage the audio system or the storage media of USB thumb drive. Check to be sure the direction is correct before connection.
2. Tap the POWER ON/STANDBY button to turn on the unit. The power indicator will be bright.
3. Tap the SOURCE button repeatedly to select USB mode, the system will start reading inserted storage device automatically. Display will briefly show "USB Reading" and then the total number of MP3 tracks plus folder and track menus.
Note: 1.) Display will show "No USB" if no USB thumb drive has been inserted into USB port or inserted USB driver is not recognized by the system.
2.) Display will show "No Disc" or "ERROR" if no playable MP3 music after reading.

● PLAY / PAUSE button ►||

- Press the PLAY/PAUSE ►|| button once to start playback the first track, press it again to pause music playback.

● STOP button ■

- Press the STOP ■ button to stop music playback, monitor will show the total track number of MP3 files.

● SKIP UP ►► / SKIP DOWN ◄◄ button

- During MP3 music playback, tap the ►► button once to skip to the next track. Press and hold the ►► button for fast forward.
- During MP3 playback, tap the ◄◄ button once to skip to the previous file. Press and hold the ◄◄ button for fast backward.

NOTE: Fast forward / backward only functions in MP3 music playback.



- **Folder searching (for MP3 or MP3+G song folder only)**

In USB stop mode, press the FOLDER UP (+) or FOLDER DOWN (-) button to skip to next / previous folder.

- **+10 track searching**

Press the +10 track button to search by advance 10 track per step if the track is far away from menu selection.

- **REPEAT 1/FOLDER/ALL FUNCTION**

- During music playback, press the PLAY MODE button once, REPEAT 1 indicator  will show in the monitor, single track will be played repeatedly. Press the PLAY MODE button twice, REPEAT FOLDER indicator  will show in the monitor, all tracks in the folder will be played repeatedly. Press the PLAY MODE button three times, REPEAT ALL indicator  will show in the monitor, it will repeatedly play all tracks in the whole usb drive.



- To clear the repeat function, press the PLAY MODE button in REPEAT ALL mode, the REPEAT OFF indicator  will show in the monitor.

REMARKS

- If you connect your system to an MP3 player via the USB port, due to variances in MP3 encoding format, some MP3 players may not be able to play via the USB port. This is not a malfunction of the system.
- There are numerous USB thumb drive producers in the market. Solution and format are variable between each producer. Therefore, we do not guarantee this unit can support all USB thumb drives from every brand.
- USB thumb drives are supported FAT 32 format, 1 GB - 64 GB maximum.

TRACKS PROGRAMMING

Up to 20 tracks can be programmed for MP3 or MP3+G files and play in any order. Before programming, be sure the system is in stop mode.

1. Insert USB thumb drive, set the unit to USB mode. Press the STOP button if unit is not in stop mode.
2. Press the PLAY MODE/PROGRAM button, "PROG SET 01: 01" will be show in color monitor, last two digits of track number indicator are flashing to prompt for input.
3. Press the ►► or ◀◀ button to select a desired track. Press the +10 track button if the track is far away from menu selection. If folder selection is required, press the FOLDER+ (UP) or FOLDER- (DOWN) button to skip to next or previous folder.
4. Press the PROGRAM button to confirm and store the track into memory. Program counter advance to "02" and flashing with programmed track number again.
5. Repeat steps 3 and 4 to enter additional tracks into the memory if necessary. When maximum of 20 tracks have been programmed, "PROG FULL" message appears briefly in the monitor and then "PROG" mode icon shows in the monitor steadily.
6. When all the desired tracks have been programmed, press the "PLAY/PAUSE" ►► button to play the tracks in assigned order.
7. Press stop ■ button to stop playing of programmed tracks, press stop ■ button again to cancel programming.

PLAYING SONGS FROM A BLUETOOTH DEVICE

The Bluetooth feature enables you to stream and play the digital music on your Bluetooth enabled device to your Karaoke Machine.

1. In power on mode, tap the SOURCE button repeatedly to select the “BLUETOOTH” mode, “Bluetooth” briefly appears and then “Bluetooth No Connect” message will show on the LCD display monitor.
2. The unit will start in auto connection mode and search for a previously paired device that is active and in range (30 feet/10 meters) with the “Bluetooth No Connect” message showing in monitor. If found, a brief welcome melody will be heard and monitor will change to show “Bluetooth Connected”. If no active device is found within 20 seconds, the unit will switch to interactive pairing mode and the “Bluetooth Pairing” will show in the monitor and flashing.
3. To establish a new link, turn on the Bluetooth function of your Bluetooth enabled device and enable the search or scan feature to find “KN355BT” in the list of discoverable Bluetooth devices. Select the “KN355BT” from your available device list when it appears on its screen and a brief welcome melody will be heard if pairing and connection is successful.
4. If no successful pairing and connection is made within 5 minutes, the unit will enter manual pairing mode and the “Bluetooth No Connect” message showing in monitor steadily. You need to press and hold the PAIR button until “Bluetooth Pairing” message flashes on the monitor to initiate a pairing/connecting request to a new or old Bluetooth enabled device. Follow step #3 to complete the process.
5. After successfully pairing and connecting your device with KN355BTB, the unit will emit a short beep and the LCD display will change to show “Bluetooth Connected” message steadily. You can now play music from your Bluetooth enabled device wirelessly to the KN355BTB.
6. If you want to connect the KN355BTB to another new external Bluetooth enabled device while paired with another device, press and hold the PAIR button for few seconds to disconnect the existing connection. The unit will emit two short beeps and LCD display will change to show “Bluetooth Paring” and flashing. Repeat steps #2 to #4 above to make a new link.
7. Rotate the VOLUME CONTROL on the front panel to increase the listening volume gradually until a comfortable listening level is reached.
8. Press the PLAY/PAUSE button to control play/pause.
9. Press the SKIP FORWARD button to skip to next song and SKIP BACKWARD button to skip to previous song.

Notes:

- If you cannot pair the unit with your Bluetooth enabled device, try solving the problem by turning the unit power off, then power on, and then starting the pairing process again.
- The Bluetooth function of the Karaoke Machine will remain paired unless the paired device goes out of range of 30 feet (10 meters). If the broken link is re-established within 20 seconds, the KN355BTB will reconnect to the current paired device automatically. Otherwise you will need to make a manual connection again later.
- You may need to turn off the Bluetooth function of the paired external device first before make a new link.
- Refer to manual of your smartphone or external Bluetooth enabled device for correct Bluetooth operation instructions since it may vary from model to model.

- If your Bluetooth enabled device does not support A2DP, it will not play the music through the KN355BTB system even after it is paired and connected successfully.
- If you are pairing and connecting your personal computer to the KN355BTB using Bluetooth, you may need to set the KN355BTB as your computer's default sound device.

RE-LINKING TO A SMARTPHONE OR BLUETOOTH ENABLED DEVICE

Even if your smartphone or Bluetooth device is already paired with the KN355BTB and with both Bluetooth functions turned on, they can become unlinked at some point due to intentional manual disconnection or undesirable external signal interferences or over-range for more than 10 seconds. If this happens, the Turntable unit will emit a low level alert beep tone. You can re-link them and resume play by:

1. Select "KN355BT" from the device list on your smartphone or Bluetooth device. The KN355BTB should re-link to your Bluetooth enabled device within 5 seconds.
2. Tap the play button of the music player on your Bluetooth enabled device to resume playback.

ANSWER THE INCOMING CALL

When your unit is playing music by Bluetooth and you receive an incoming call on your mobile phone, the music will stop and the ring tone will sound from your mobile phone. When you end the call, the music will play again automatically.

LED LIGHT SHOW

- To turn off the LED light show, press the LIGHT SHOW button.
- To turn on the LED light show, press LIGHT SHOW button again.

Note: If the brightness is glaring, turn on room lights or turn off LED light show.

RESETTING THE UNIT

If the system does not respond or exhibits erratic or intermittent operation, you may have experienced an electrostatic discharge (ESD) or a power surge that triggered the internal microcontroller to shut down automatically. If this occurs, simply disconnect the AC Adapter. Wait for at least 3 minutes and then setup the unit again as if you were using it for the very first time.

CARE AND MAINTENANCE

1. Clean your unit with a damp (never wet) cloth. Solvent or detergent should never be used.
2. Avoid leaving your unit in direct sunlight or in hot, humid or dusty places.
3. Keep your unit away from heating appliances and sources of electrical noise such as fluorescent lamps or motors.
4. If drop-outs or interruptions occur in the music during CD play, or if the CD fails to play at all, its bottom surface may require cleaning. Before playing, wipe the disc from the center outwards with a good soft cleaning cloth.



TROUBLESHOOTING GUIDE

PROBLEM	POSSIBLE CAUSE	SOLUTION
No power when plugged in	AC adapter is not plugged into the AC outlet.	Insert the AC adapter into the AC outlet.
	The AC outlet may not have power.	Check the outlet with a working lamp or other electrical appliance.
No sound	Master volume control is set to minimum.	Turn up the master volume.
	Volume control on TV set/PA system is set to minimum.	Turn up the volume of the TV/PA system.
	TV set/PA system power is OFF.	Turn on the power at TV/PA system.
CD PLAYER does not work normally or the TFT color monitor shows "No Disc"	Disc inserted upside down.	Insert disc correctly.
	Cable plugged into AUX IN jack.	Remove AUX IN cable
	Disc is dirty.	Wipe it clean with soft cloth.
	Disc is scratched or warped	Use a new disc.
	A non-standard disc is inserted.	Only use discs bearing identification logos.
	Lens is dirty.	Clean the optical pickup with a CD lens cleaner.
	Moisture has formed inside the CD deck.	Wait about 20 to 30 minutes to let it dry out.
Cannot pair with a new Bluetooth enabled device	An active paired Bluetooth device is already connected to KN355BTB system.	You need to turn off the Bluetooth function of the currently connected external Bluetooth device so as to release the KN355BTB system for a new pairing and connection.
	USB port does not work normally or the TFT color monitor shows "No USB"	Insert the USB thumb drive properly and firmly
USB port does not work normally or the TFT color monitor shows "No USB"	USB thumb drive is not inserted properly.	Insert the USB thumb drive properly and firmly
	USB thumb drive is not supported in this system.	Try some USB thumb drives which can be supported in this system
	No playable file.	Make sure your USB thumb drive has playable files in MP3 or MP3+G format.
No sound through TV home stereo	Source selection on your TV home stereo is not set properly.	Select AUX IN as the source for your TV home stereo.
	Improper connection to stereo system or PA.	Follow directions on 'Audio Connection' page for connecting to a home stereo system.
	Video cable is not connected properly to the TV.	Connect the video cable to the VIDEO OUT of the unit and to the TV VIDEO IN jacks.

No song lyrics appear on the Built-in Monitor or External TV screen	“Source” selector on TV is not set to VIDEO or A/V IN	Use your TV Remote to select VIDEO or A/V input.
	TV does not have video line input.	Connect from VIDEO OUT of the unit to a RF modulator and then to the TV cable input.
	A CD+G disc is loaded but the CD+G indicator is not lit.	Check the disc to be sure it is a CD+G. Check disc to ensure it is clean.
Cannot sing through the mic.	Improper mic volume control.	Adjust MIC and MASTER volume level controls to appropriate levels.
	Mic is off.	Turn on mic with the ON/OFF switch located on the microphone.
	Mic is not properly plugged in.	Insert the mic plug into either MIC 1 or MIC 2 jack of the unit properly.

SPECIFICATIONS

Built-in Monitor	: 4.3 inch TFT color monitor
Audio Output Power	: 5W (RMS)
USB port	: Supports FAT 32 format, 1 GB - 64 GB maximum USB thumb drives
Speaker	: 1 x 4 inch / 8 ohms
Aux In Jack	: 1 x 3.5 mm
Microphone Inputs	: 2 x 600 ohms Impedance with 6.3 mm jack
Microphone	: 2 x Dynamic Microphones
Power Source :	
AC Adapter:	Input AC 240V~ 50Hz 0.5A Output DC 12V --- 1.5A 



Adapter's manufacturer: SHEZHEN SHI GUANGKAIYUAN TECHNOLOGY., LTD
(model : GKYPSO150120AU1)

Due to continuing improvement, the features and the design are subject to change without notice.

Karaoke Night products are designed and engineered by Marino Andriani, LLC

The *Bluetooth*® word mark and logos are registered trademarks owned by Bluetooth SIG, Inc. and any use of such marks by Spectra Merchandising Intl, Inc. is under license. Other trademarks and trade names are those of their respective owners.

SERVICE

All necessary care is taken at the point of manufacture to ensure this unit will perform to the manufacturer's highest quality standards. However, if this unit becomes faulty within the warranty period, please return your unit to the point of purchase with your proof of purchase date for a replacement or refund. When returning the unit, please remove all batteries to prevent damage to the unit in transit and/or from possible leakage. We are not responsible for batteries returned with the product or for the cost of replacement.

For further information on this product please contact:

K2 Sales Pty Ltd
PO Box 696
Black Rock, Victoria 3193
Australia

Email: accounts@k2sales.com.au

The specification and external appearance of the set are subject to change without prior notice.

0720

Printed in China