

Assembly Instructions

42967255 E/WAY STORAGE ANDERS

CARE INSTRUCTION:











TO BE ASSEMBLED ON A CLEAN, DRY AND SMOOTH SURFACE. WIPE CLEAN WITH A SOFT DAMP CLOTH. NEVER USE SCOURERS, ABRASIVES OR CHEMICAL SOLVENTS. CHECK AND TIGHTEN ALL PARTS REGULARLY. KEEP AWAY FROM MOISTURE AND DIRECT SUNLIGHT. STORE IN A DRY PLACE. FOR INDOOR AND DOMESTIC USE.

WARNINGS:

DO NOT STAND OR LEAN ON THIS UNIT. DO NOT USE THIS UNIT AS A STEP LADDER. ENSURE THIS UNIT IS USED ONLY ON A FLAT SURFACE. DO NOT USE THIS UNIT UNLESS ALL BOLTS AND SCREWS ARE FIRMLY SECURED. KEEP AWAY FROM CHILDREN AND BABIES. THIS PACKAGE CONTAINS SMALL PARTS AND SHARP POINTS. ADULT ASSEMBLY REQUIRED. A MILD ODOUR MAY BE PRESENT WHEN FIRST OPENING THIS CARTON. SIMPLY ALLOW TO AIR OUTSIDE AND THIS WILL FADE.

MAXIMUM SAFE LOAD: 100KG FOR SEAT,10KG FOR BOTTOM SHELF,3KG FOR EACH HOOK.

Hardware List

	a	6x40mm	4pcs		f		1pc
	b	10x9.5mm	4pcs		g		4pcs
	c	6x30mm	16pcs		h	3x12mm	4pcs
	d	4x55mm	12pcs		i		2pcs
	e	6x45mm	24pcs		j	4x35mm	2pcs
					k		24pcs

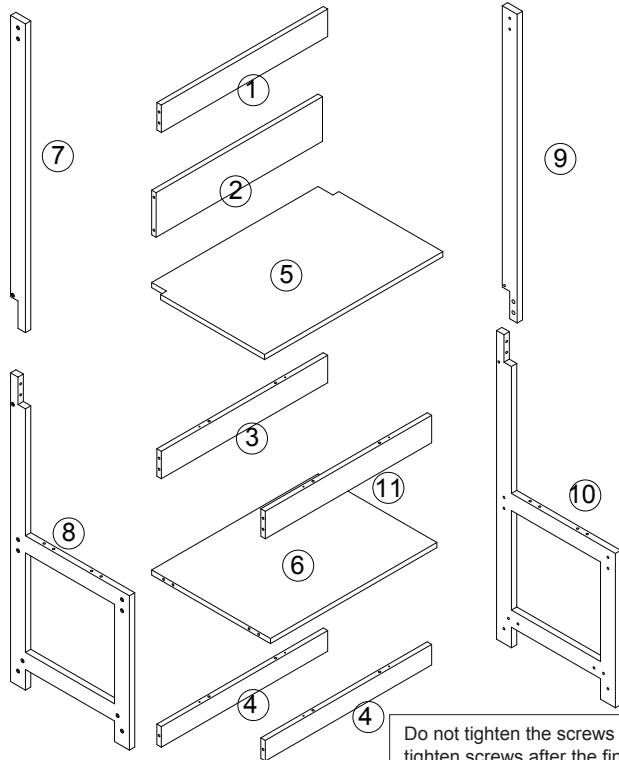

Do not tighten the screws fully during assembly. Fully tighten screws after the final assembly steps.

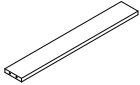
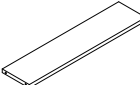
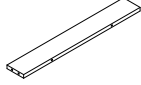
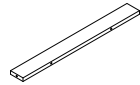
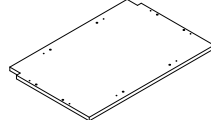
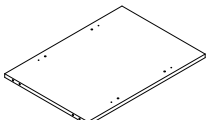
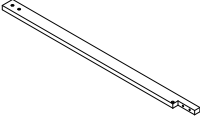
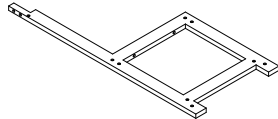
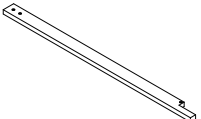
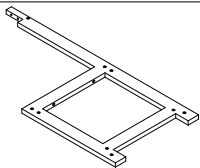
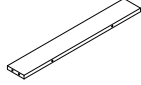
					
①	1PC	②	1PC	③	1PC
					
④	2PCS	⑤	1PC	⑥	1PC
					
⑦	1PC	⑧	1PC	⑨	1PC
					
⑩	1PC	⑪	1PC		

Step 5:

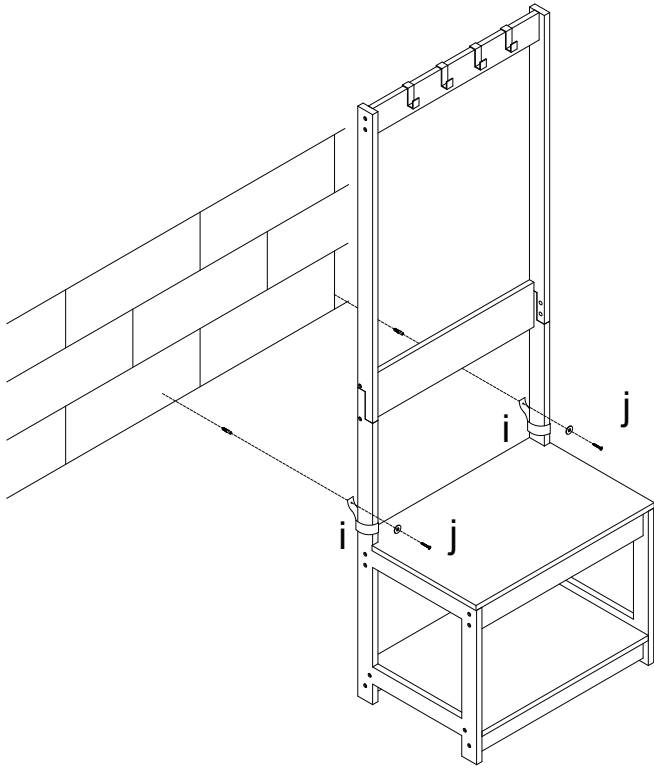
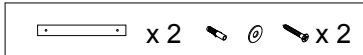

Step 6:

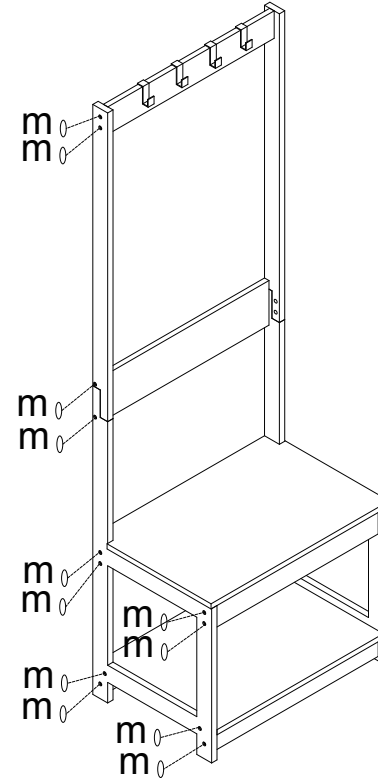
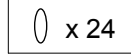

It is strongly recommended that this product is permanently fixed to the wall. Please seek professional advice if you are in doubt of what fixing device to use.

Regularly check that anchors are securely maintained.

CAUTION: for your safety when attaching the anchor fixings, please note the following: Check any electrical wires or plumbing inside the wall before drilling any holes (if you are unsure please seek professional advice from a qualified tradesperson).