

# Assembly Instructions

## 42980254 EGON SIDBOARD











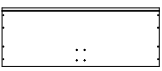







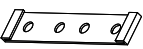







### CARE INSTRUCTION:

WIPE CLEAN WITH A SOFT DRY OR DAMP CLOTH. KEEP AWAY FROM WATER AND DIRECT SUNLIGHT.FOR INDOOR AND DOMESTIC USE. DO NOT PUT HOT ITEMS SUCH AS COFFEE CUPS DIRECTLY ON THE SURFACE OF THIS FURNITURE ITEMS. CHECK AND TIGHTEN ALL PARTS REGULARLY.

### WARNINGS:





DO NOT STAND OR SIT ON THE UNIT.DO NOT LEAN ON THE PRODUCT.DO NOT DRAG THE PRODUCT.USE ONLY ON A FLAT SURFACE.DO NOT USE UNTIL ALL SCREWS, BOLTS AND KNOBS ARE FIRMLY SECURED.THIS PRODUCT CONTAINS SMALL PARTS AND SHARP POINTS, KEEP AWAY FROM CHILDREN AND BABIES. ADULT ASSEMBLY REQUIRED.FAILURE TO FOLLOW THESE WARNINGS COULD RESULT IN SERIOUS INJURY. **MAXIMUM SAFE LOAD: 15KG FOR TOP,15KG FOR INSIDE SHELF**

### Hardware List

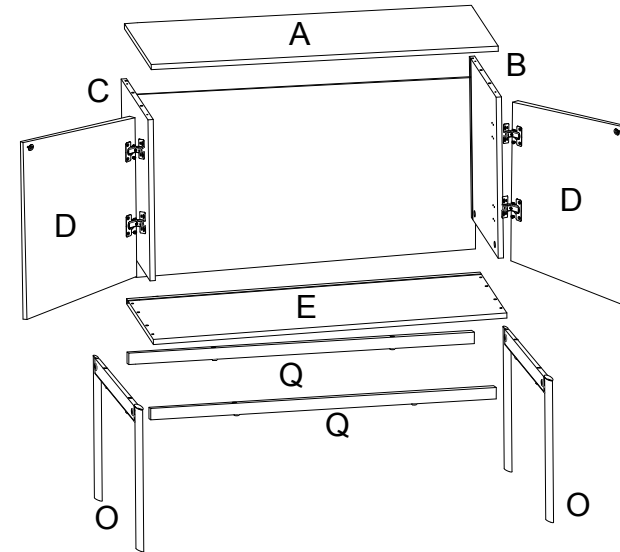
A		1pc	N	 M6X38mm	8pcs
B		1pc	O		2pcs
C		1pc	P		4pcs
D		2pcs	Q		2pcs
E		1pc	R		2pcs
F		1pc	S		2pcs
G		8pcs	T	 M4x35mm	4pcs
H		4pcs	U	 M6x30mm  M4x35mm	2pcs
I	 M4X15mm	4pcs	V	 30x180mm  M4x12mm	2pcs
J		4pcs	W		2pcs
K		4pcs	X		1pc
L	 M4X10mm	28pcs	Y	 M3x8mm	2pcs
M	 M6X30mm	4pcs			

**ATTENTION:**  
DO NOT TIGHTEN THE SCREWS FULLY DURING ASSEMBLY.  
FULLY TIGHTEN SCREWS AFTER THE FINAL ASSEMBLY STEP.



Step 1  G x 4  H x 4  J x 4  L x 4  R x 2  S x 2

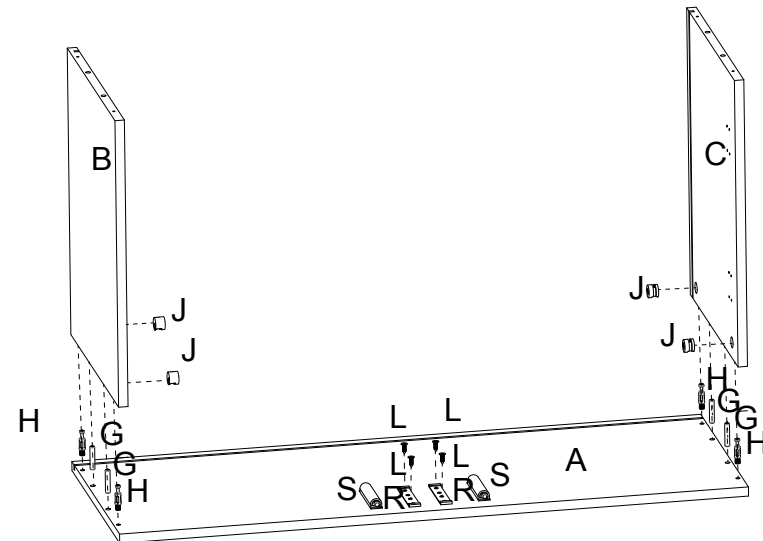

Step 2  K x 4  L x 8  W x 2  Y x 2

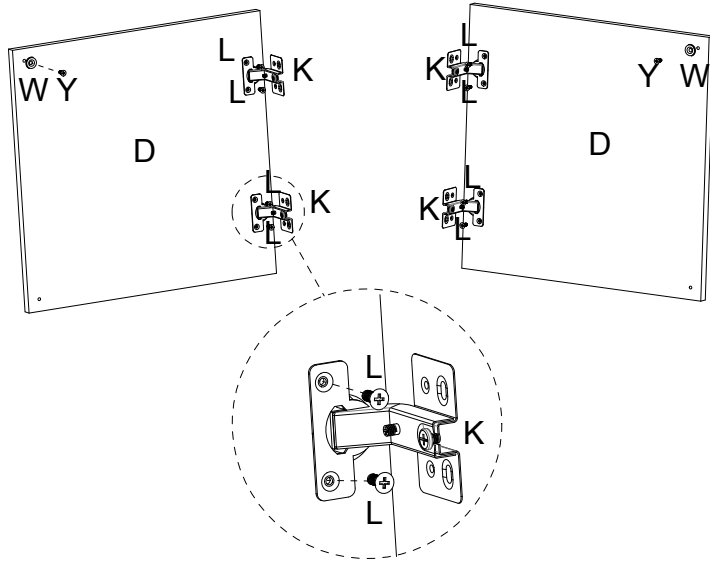

Step 4

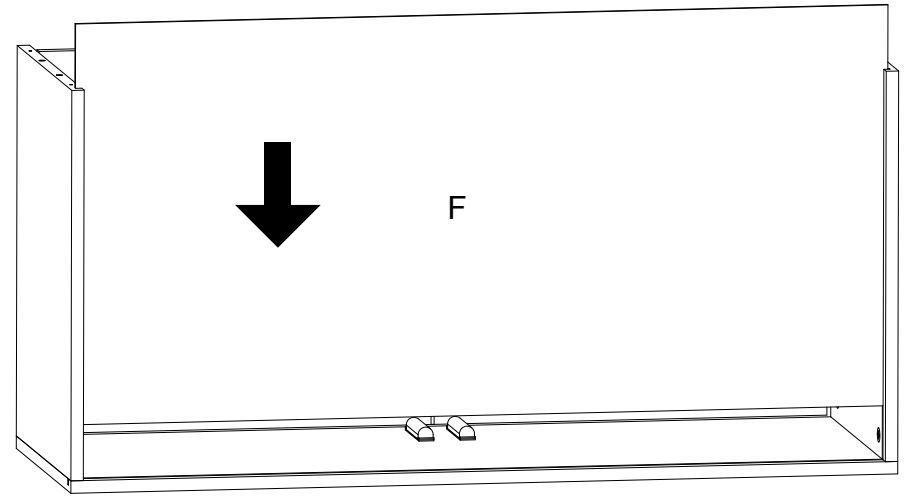

Step 3  L x 16

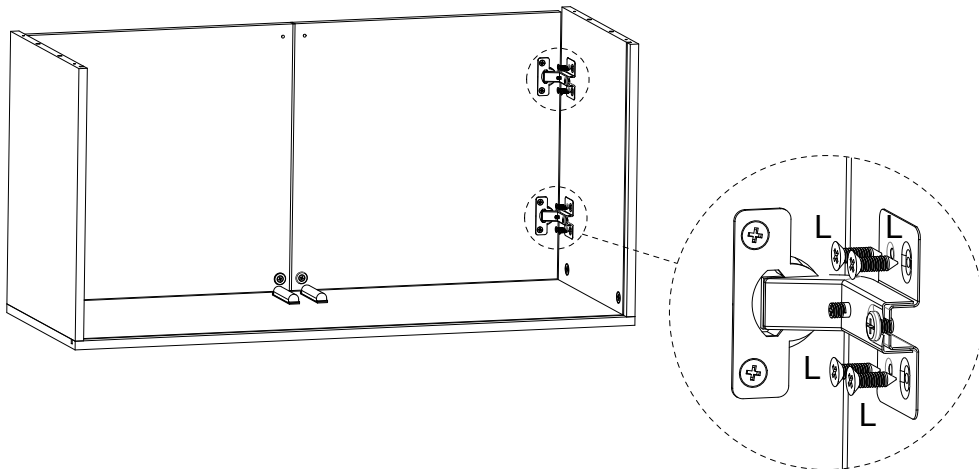

Step 5  G x 4  T x 4

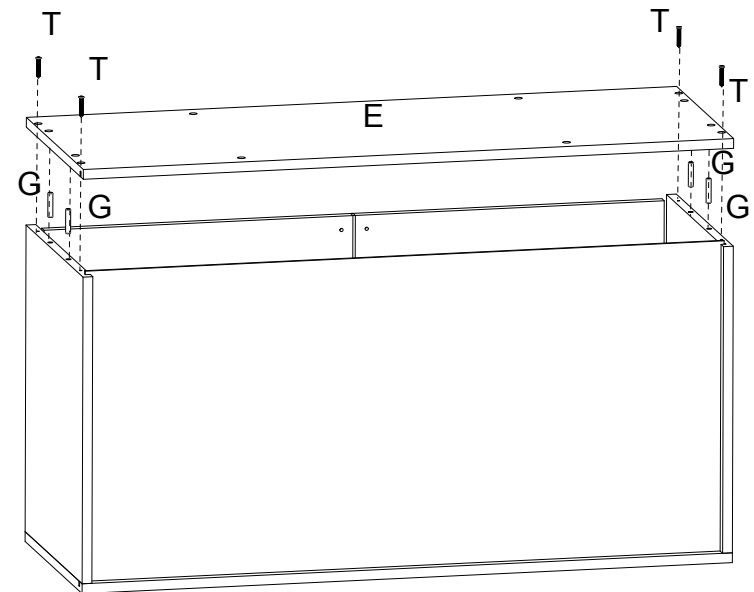

Step 6  M x 4  N x 8  P x 4  I x 4

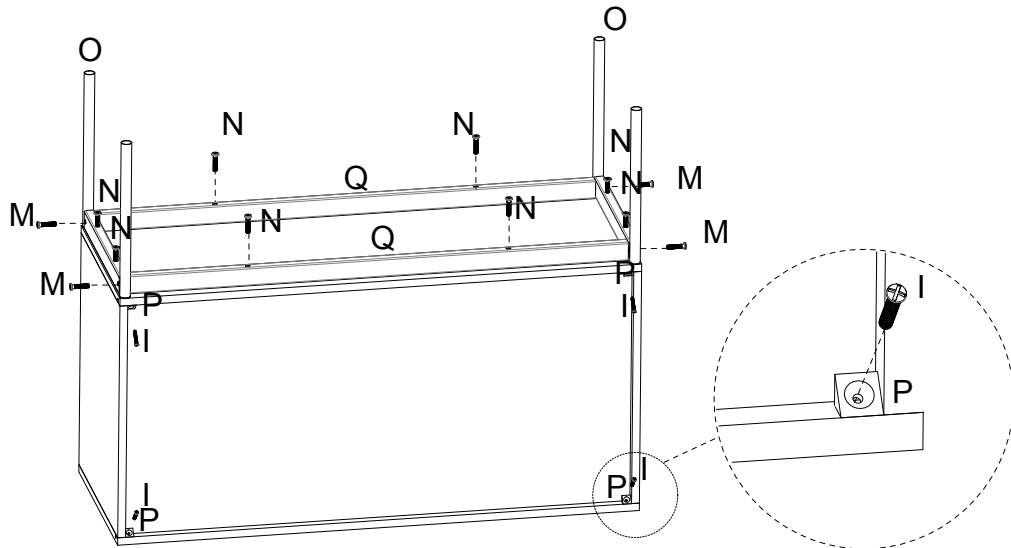

Step 7: Please flip over this unit after Step 6 finished

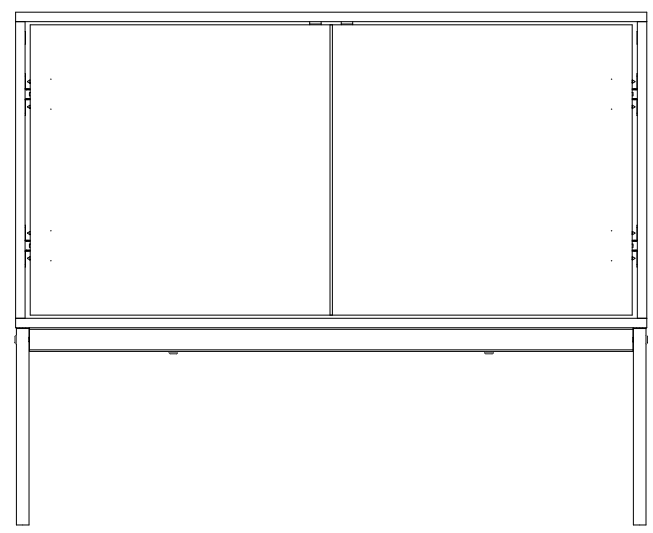

Step 8  U x 2  V x 2

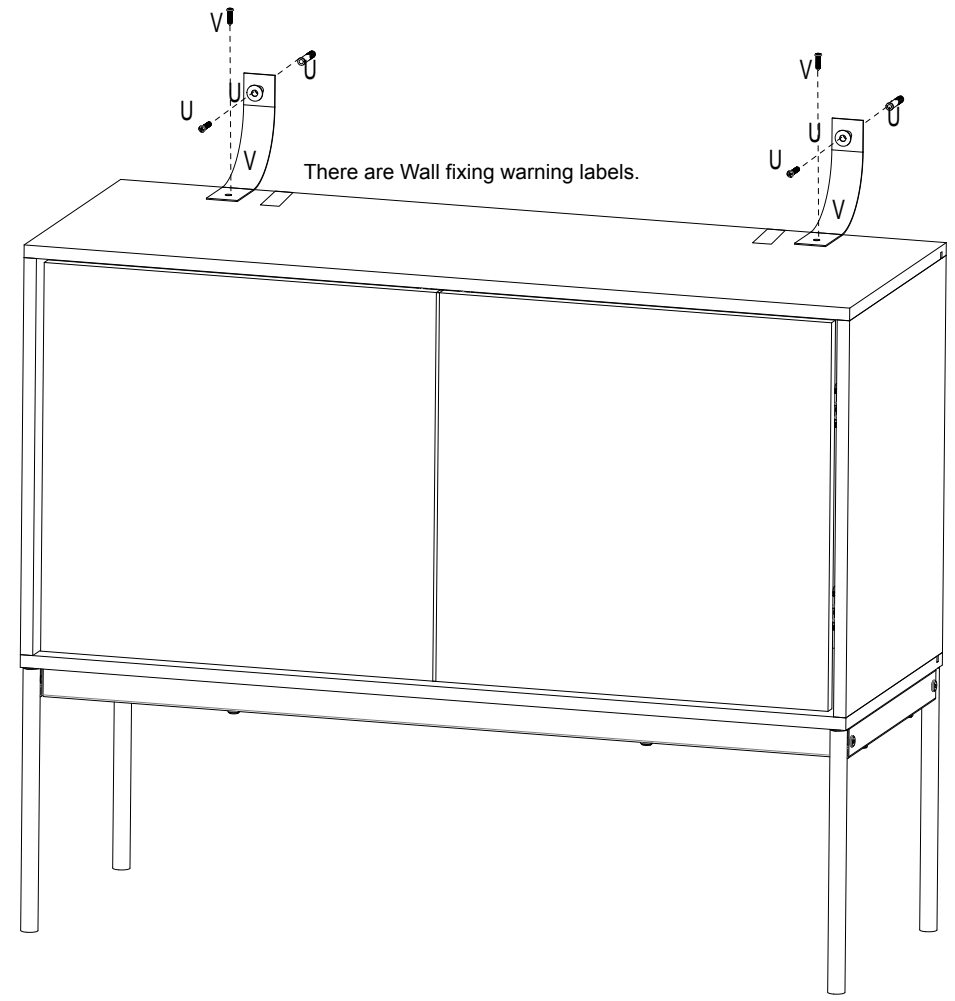

It is strongly recommended that this product is permanently fixed to the wall. Please seek professional advice if you are in doubt of what fixing device to use. Regularly check that anchors are securely maintained.

**CAUTION:** for your safety when attaching the anchor fixings, please note the following: Check any electrical wires or plumbing inside the wall before drilling any holes (if you are unsure please seek professional advice from a qualified tradesperson).