

Trampoline Basketball Hoop Instruction Manual

Keycode 43032877

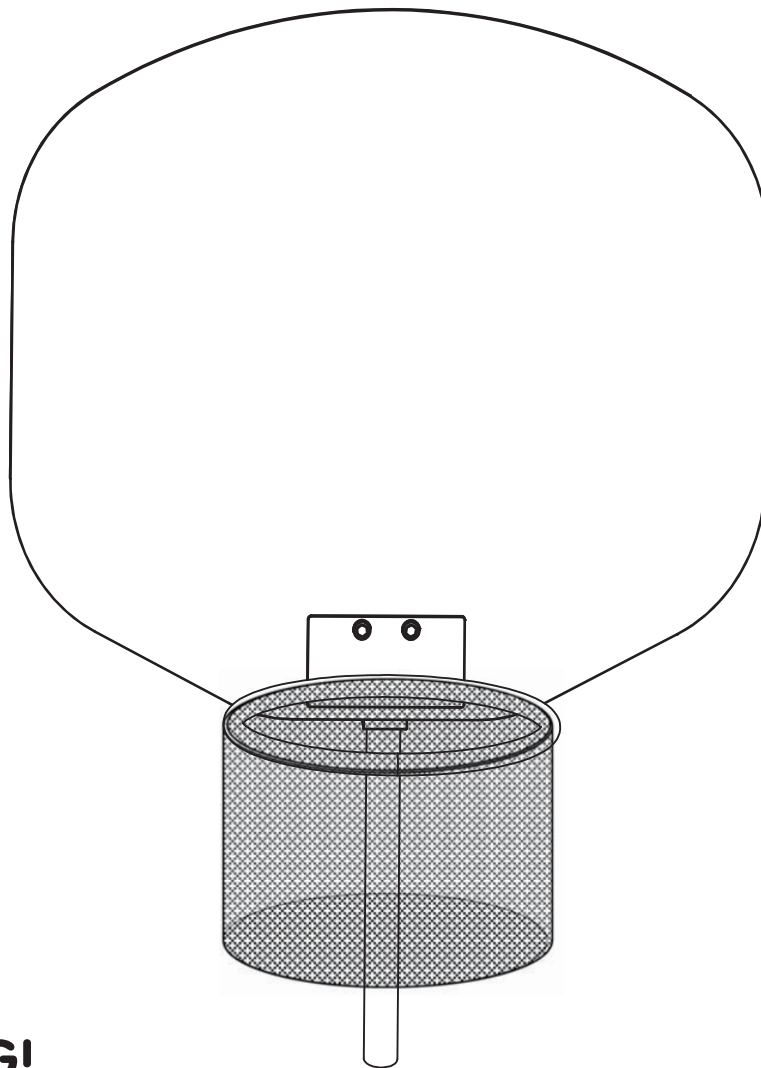





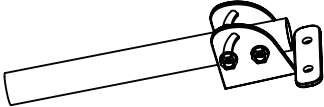
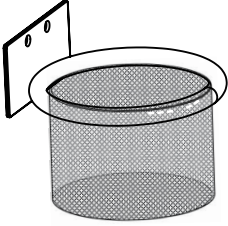
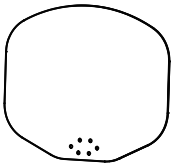

WARNING!

THIS MUST BE ASSEMBLED BY AN ADULT BEFORE USE.
THIS PRODUCT CONTAINS SMALL PARTS AND IS NOT SUITABLE FOR CHILDREN UNDER 36 MONTHS. SMALL PARTS. CHOKING HAZARD.
CHILDREN MUST NOT USE THE EQUIPMENT UNTIL PROPERLY INSTALLED.
ONLY FOR DOMESTIC USE.
FOR OUTDOOR USE.
ADULT SUPERVISION IS REQUIRED.
REMOVE ALL PACKAGING BEFORE GIVING TO YOUR CHILDREN. RETAIN PACKAGING FOR FUTURE REFERENCE.
THIS PRODUCT IS INTENDED FOR USE BY CHILDREN AGED 6+ YEARS.
CHECK ALL FASTENINGS REGULARLY AND OFTEN. FAILURE TO DO THIS MAY RESULT IN THE PRODUCT MALFUNCTIONING, AND CAUSING INJURY.

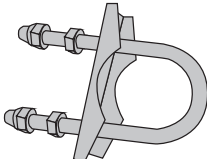
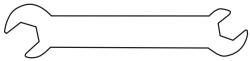
WARNING: IMPROPER INSTALLATION OR SWINGING ON THE RING MAY CAUSE SERIOUS INJURY OR DEATH.

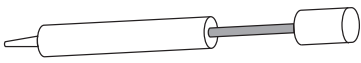
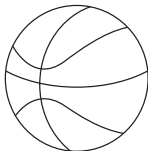

PART #	PART DESCRIPTION	QTY
1	 Pole + metal bracket	1
2	 Basketball hoop	1
3	 Basketball backboard	1
4	 Screw M6*25+ M6 White nut with cap+ M6 spacer *1PC	2
5	 U hook	2
6	 Spanner	1
7	 Hex key	1
8	 Air pump	1
9	 Basketball	1
10	 Protection fabric	1

1

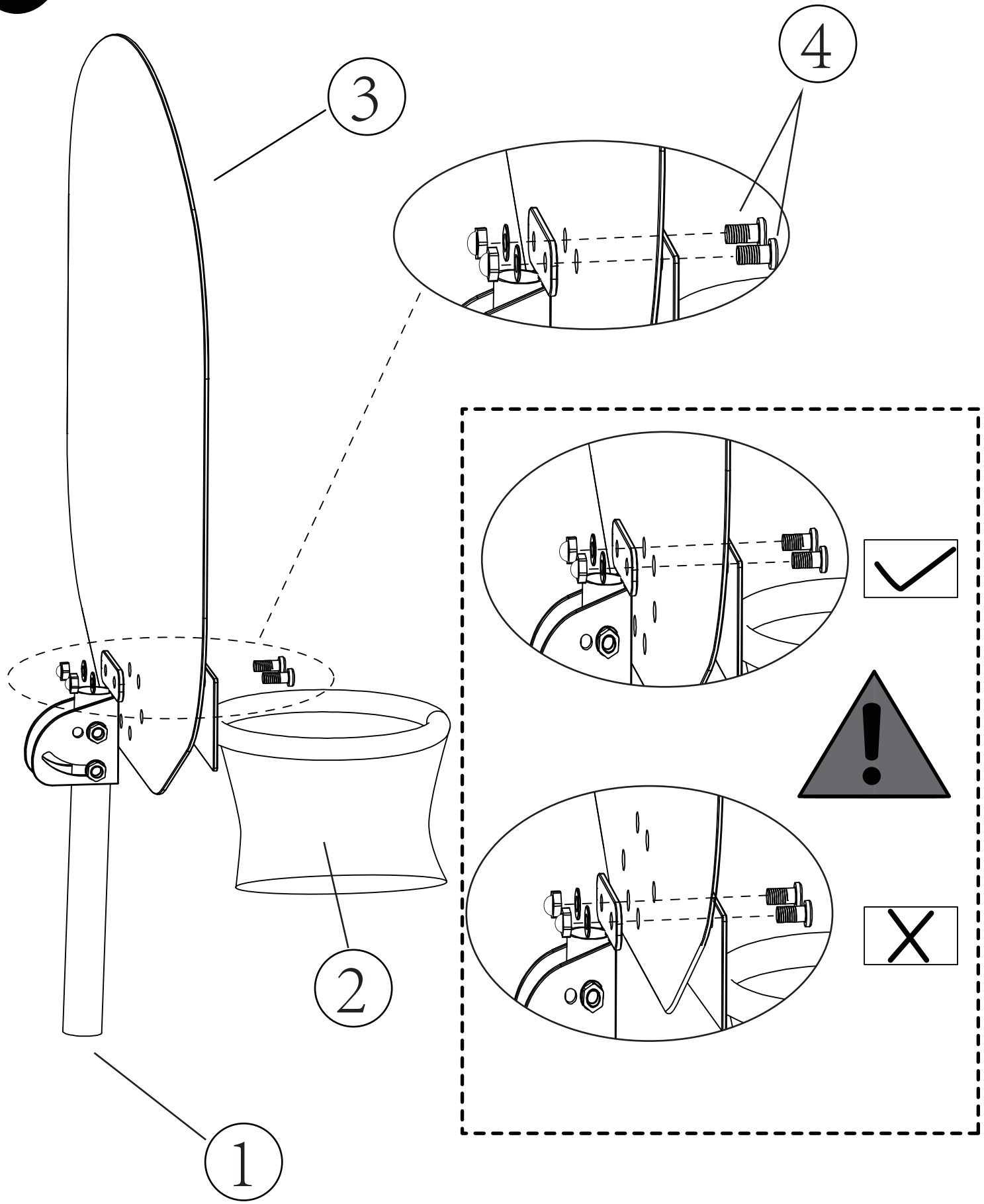

2

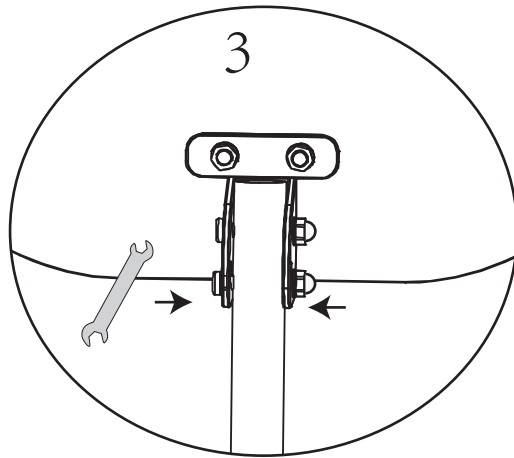
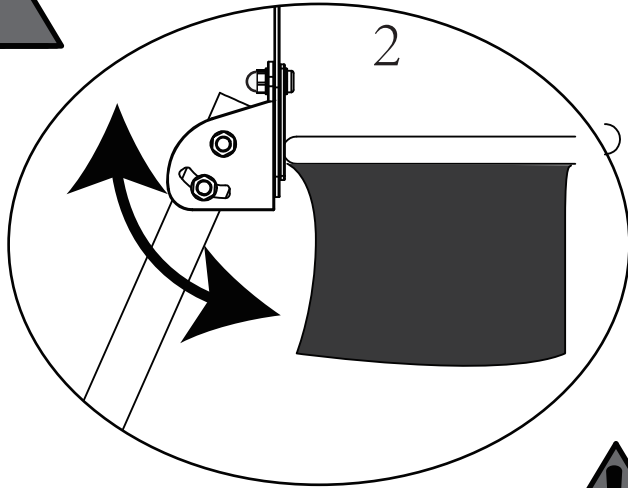
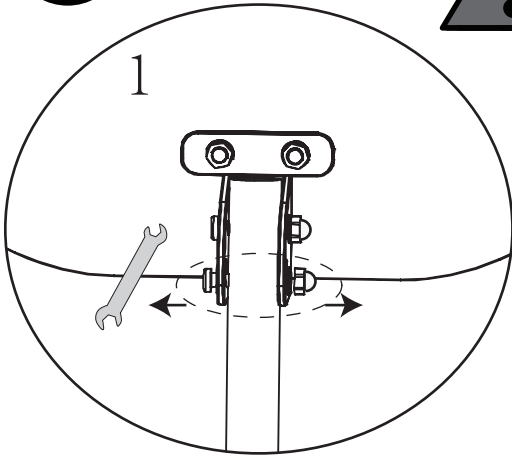

Once installed, tilt the backboard so that it is vertical to the trampoline floor

3 Connect basketball ring enclosure pole to trampoline enclosure pole.

10

5