

Assembly Instructions

CARE INSTRUCTIONS:























TO BE ASSEMBLED ON A CLEAN, DRY AND SMOOTH SURFACE , WIPE CLEAN WITH A SOFT DAMP CLOTH.NEVER USE SCOURERS, ABRASIVE SCREWS OR CHEMICAL SOLVENTS. CHECK AND TIGHTEN ALL PARTS REGULARLY.KEEP AWAY FROM MOISTURE AND DIRECT SUNLIGHT. STORE IN A DRY PLACE. FOR INDOOR AND DOMESTIC USE ONLY.



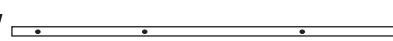

WARNING!

NOT SUITABLE FOR CHILDREN UNDER 8 YEARS OLD. SMALL PARTS, SMALL BALL. CHOKING HAZARD.

ASSEMBLED BY ADULT. DO NOT PUSH THE SCREWS TOO HARD AND FAST TO AVOID THE BOARD BREAKING.DO NOT STAND, SIT OR LEAN ON THIS TABLE.DO NOT USE THIS TABLE AS A STEP LADDER OR AS A CHOPPING SURFACE.ENSURE THIS TABLE IS USED ONLY ON A FLAT SURFACE.DO NOT USE THIS TABLE UNLESS ALL BOLTS AND SCREWS ARE FIRMLY SECURED.DO NOT PLACE HOT ITEMS SUCH AS COFFEE CUPS DIRECTLY ON THE SURFACE OF THIS GAME TABLE.KEEP THE GAME TABLE AGAINST WALL ON FLAT FLOOR AFTER BEING FOLDED. DO NOT PUSH OR DRAG THE GAME TABLE AFTER BEING FOLDED.KEEP CHILDREN AWAY FROM IT AFTER BEING FOLDED. A MILD ODOUR MAY BE PRESENT WHEN FIRST OPENING THIS CARTON.SIMPLY ALLOW TO AIR OUT AND THIS WILL FADE.FAILURE TO FOLLOW THESE WARNINGS COULD RESULT IN SERIOUS INJURY.

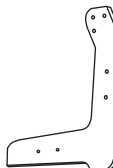
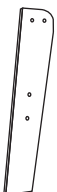
Hardware List

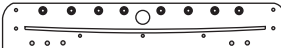
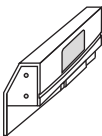
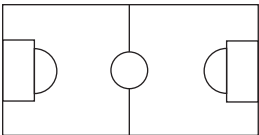
	A	∅6	28pcs		M		16pcs
	B	∅6x30mm	12pcs		N		2pcs
	C	∅6x40mm	12pcs		O		11pcs
	D	6x45mm	4pcs		P		11pcs
	E	M6	12pcs		Q	balls	3pcs
	F	4x12mm	6pcs		R		8pcs
	G	3x18mm	4pcs		S		8pcs
	H	4mmx 20mm	26pcs		T	hex key	1pc
	I	w4mm	26pcs		U		2set
	J	4x40mm	6pcs		V		4pcs
	K		4pcs		W		2pcs
	L		16pcs		X		2pcs

1	1pc	2	1pc	3	1pc
					
4	1pc	5	2pcs	6	2pcs
					
7	1pcs	8	3pcs	9	3pcs
					

Step 1:

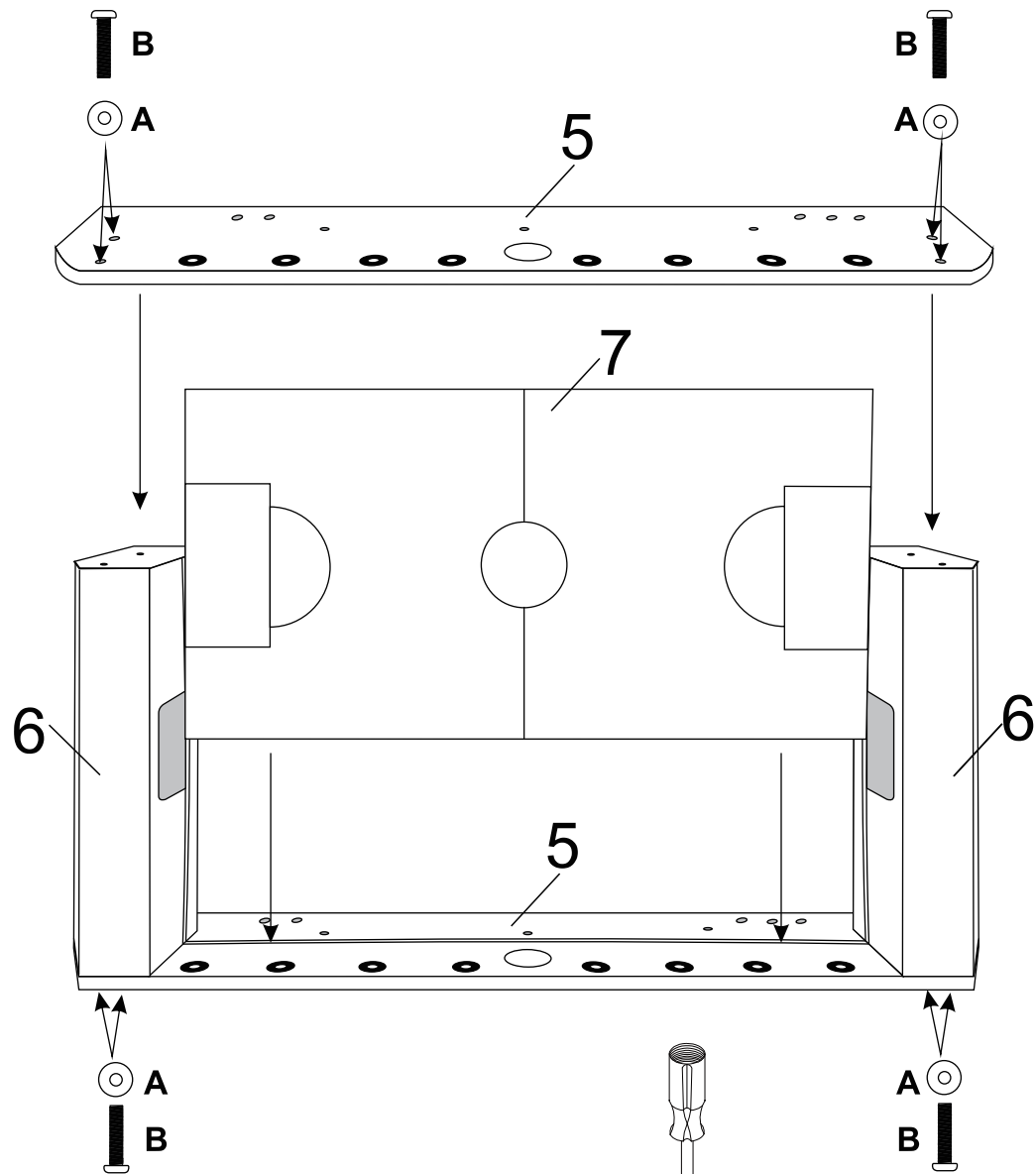

A x 8pcs
B x 8pcs

Tool required
Philips Head Screw Driver
(Not Provided)

Step 2:

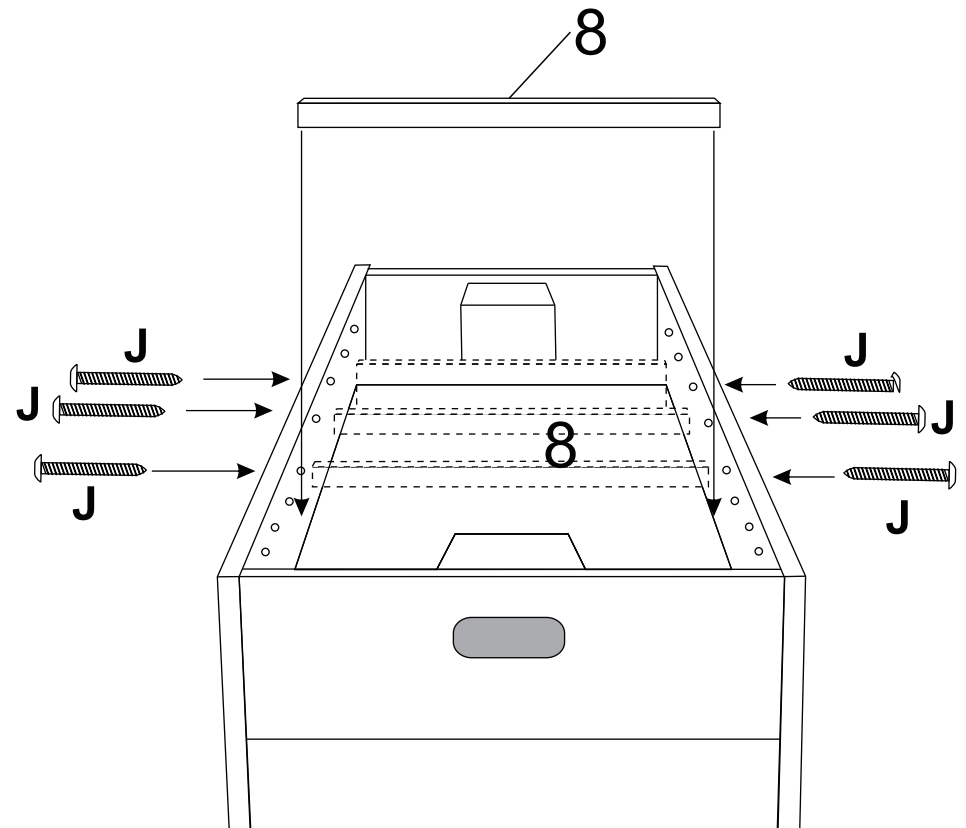

Tool required
Philips Head Screw Driver
(Not Provided)

J x 6pcs

Step 3:

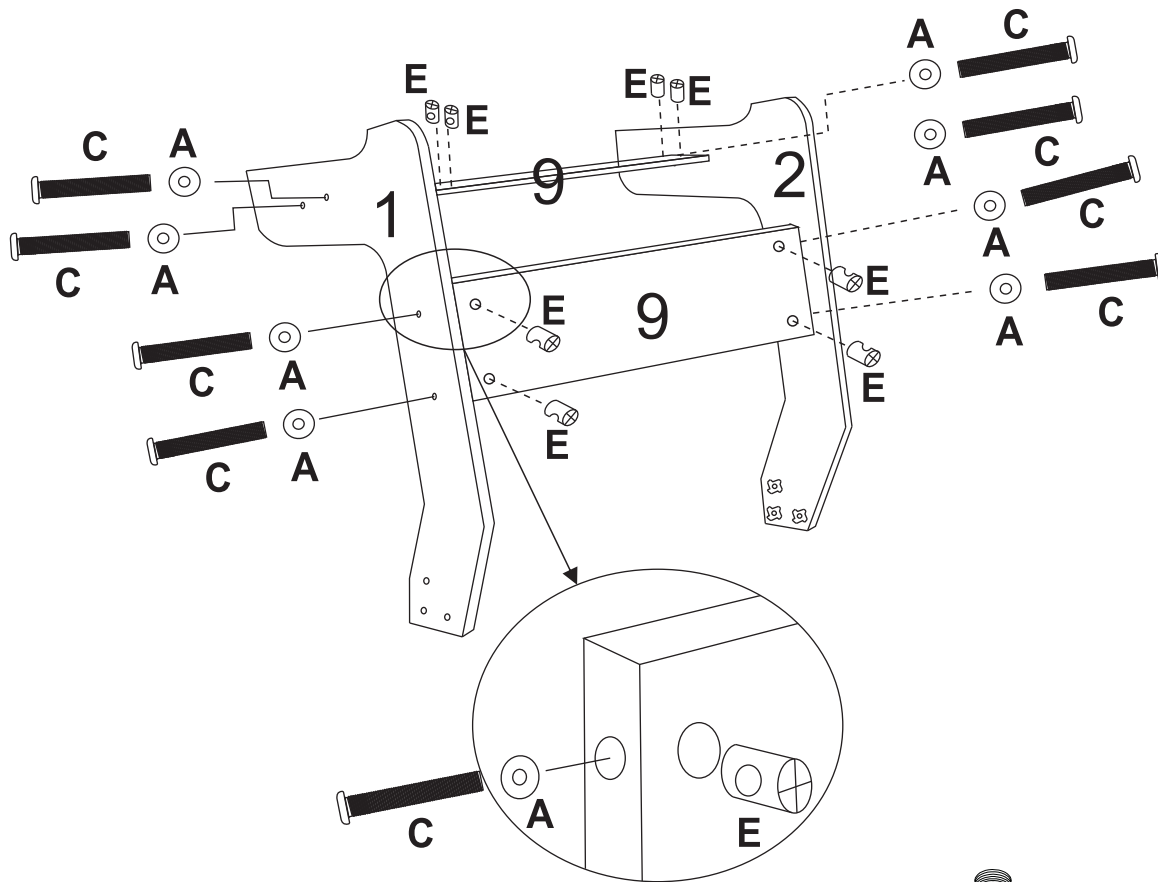

A x 8pcs
C x 8pcs
E x 8pcs

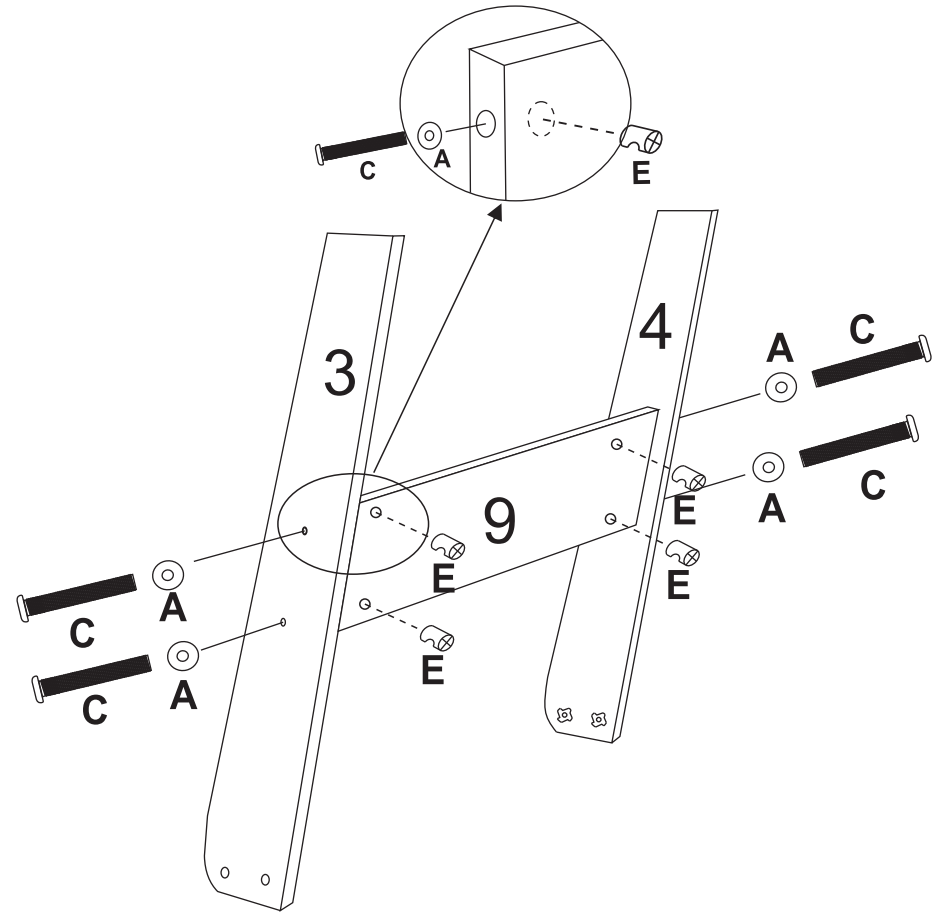
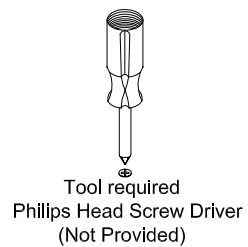

A x 4pcs
C x 4pcs
E x 4pcs

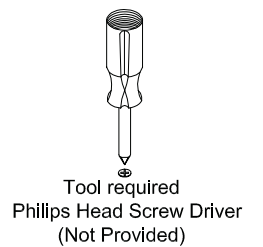

Step 4:

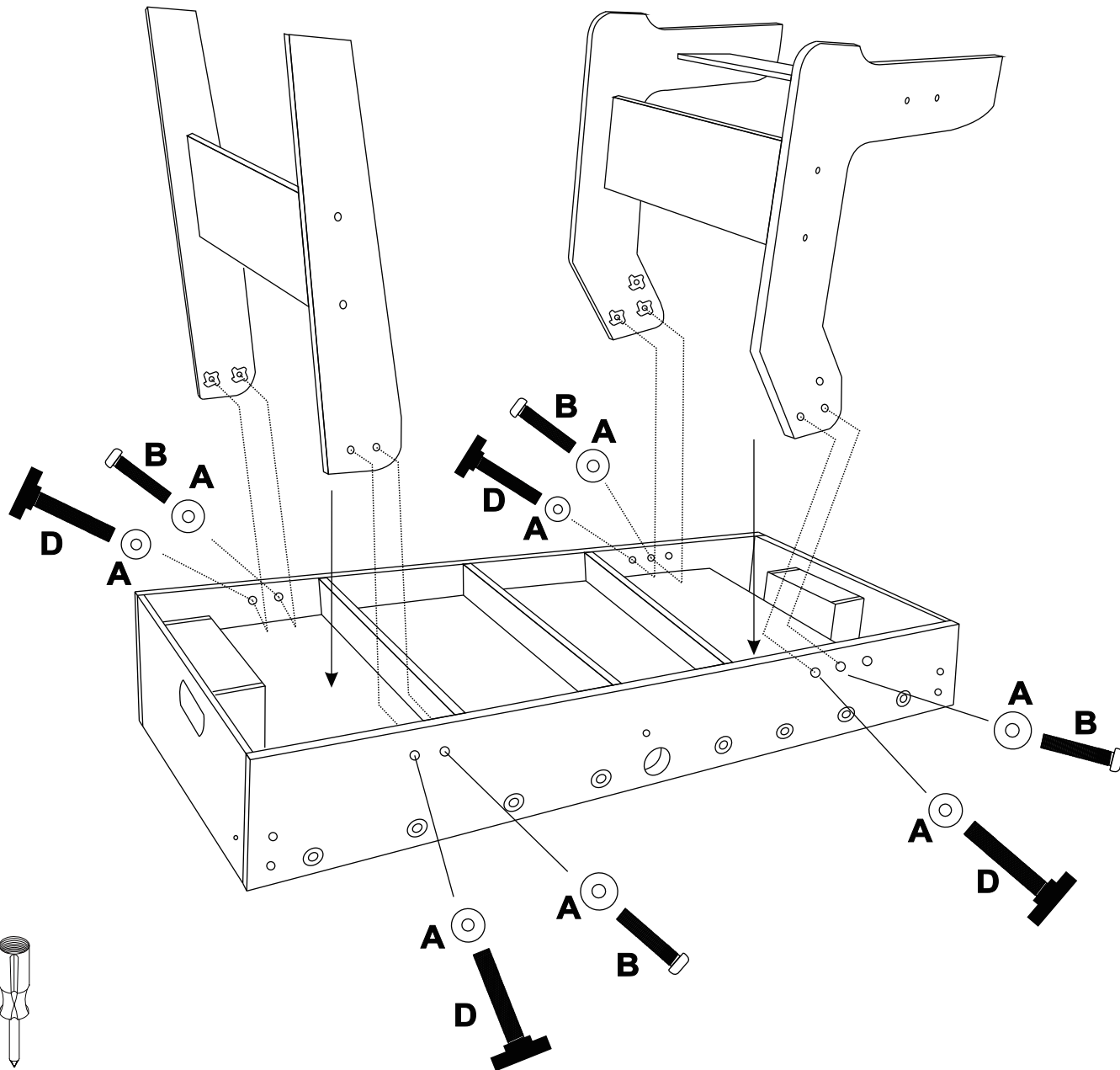

Step 5:

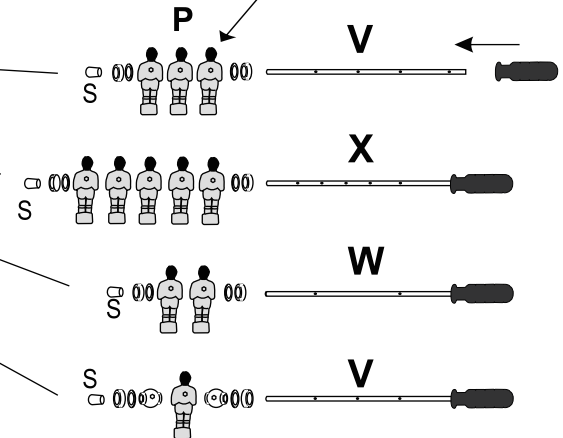
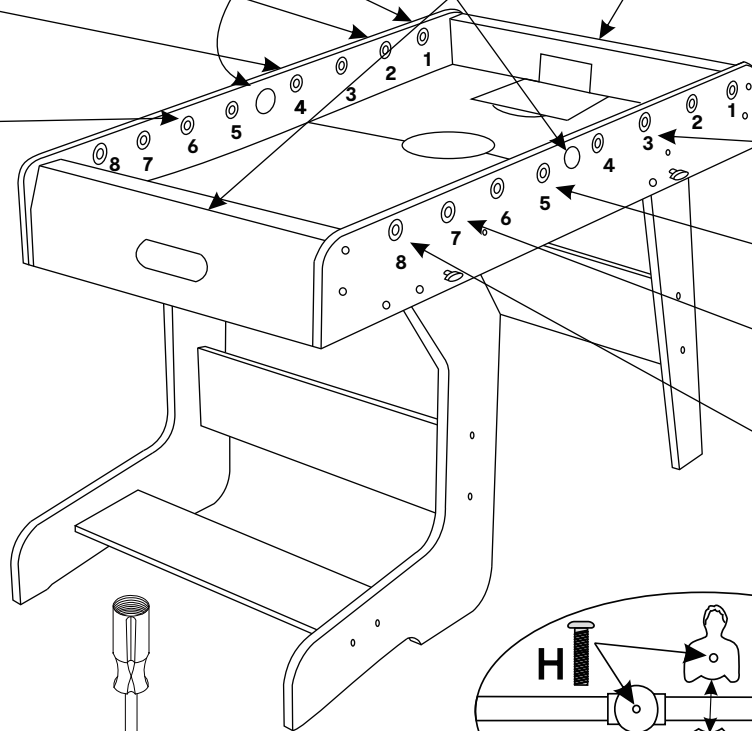
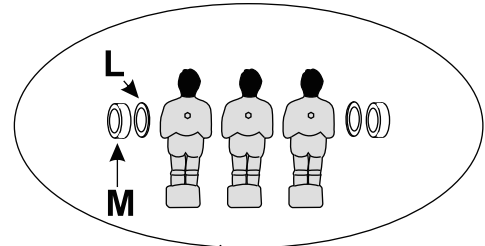
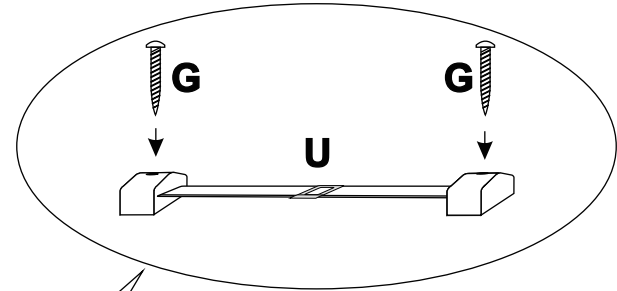
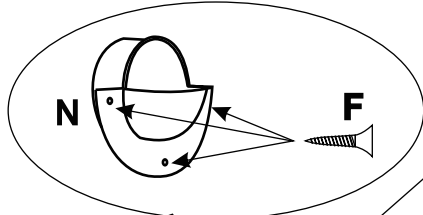
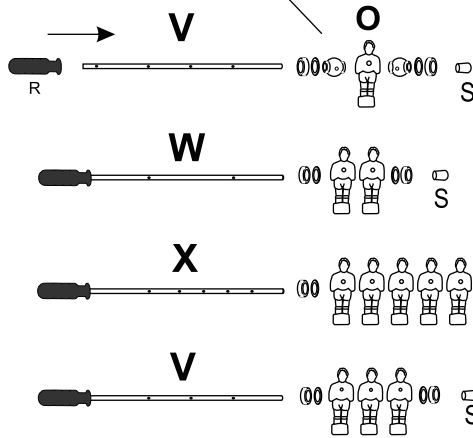
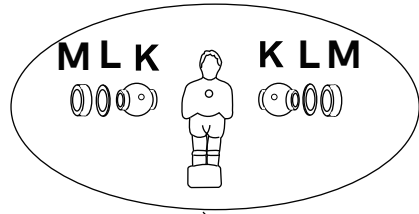

- | | |
|-----------|-----------|
| F x 6 pcs | O x 11pcs |
| G x 4pcs | P x 11pcs |
| H x 26pcs | R x 8pcs |
| I x 26pcs | S x 8pcs |
| K x 4pcs | U x 2pcs |
| L x 16pcs | V x 4pcs |
| M x 16pcs | W x 2pcs |
| N x 2pcs | X x 2pcs |

 Tool required
 Phillips Head Screw Driver
 (Not Provided)

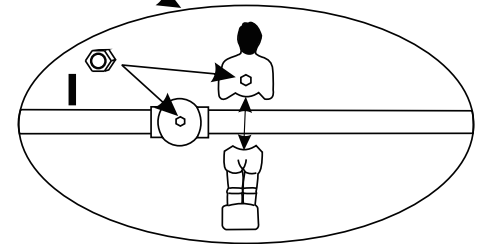
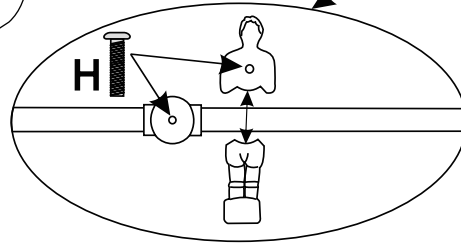

Step 6:

The product can be folded by turning the screws A.

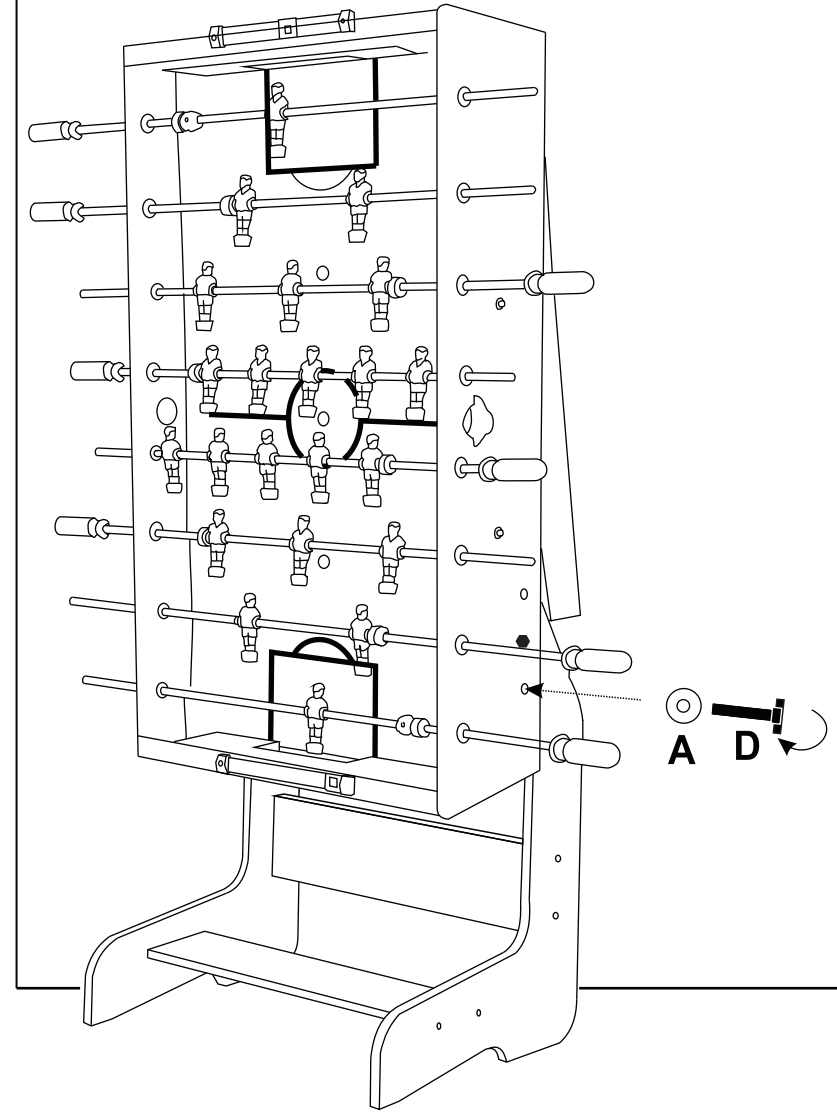
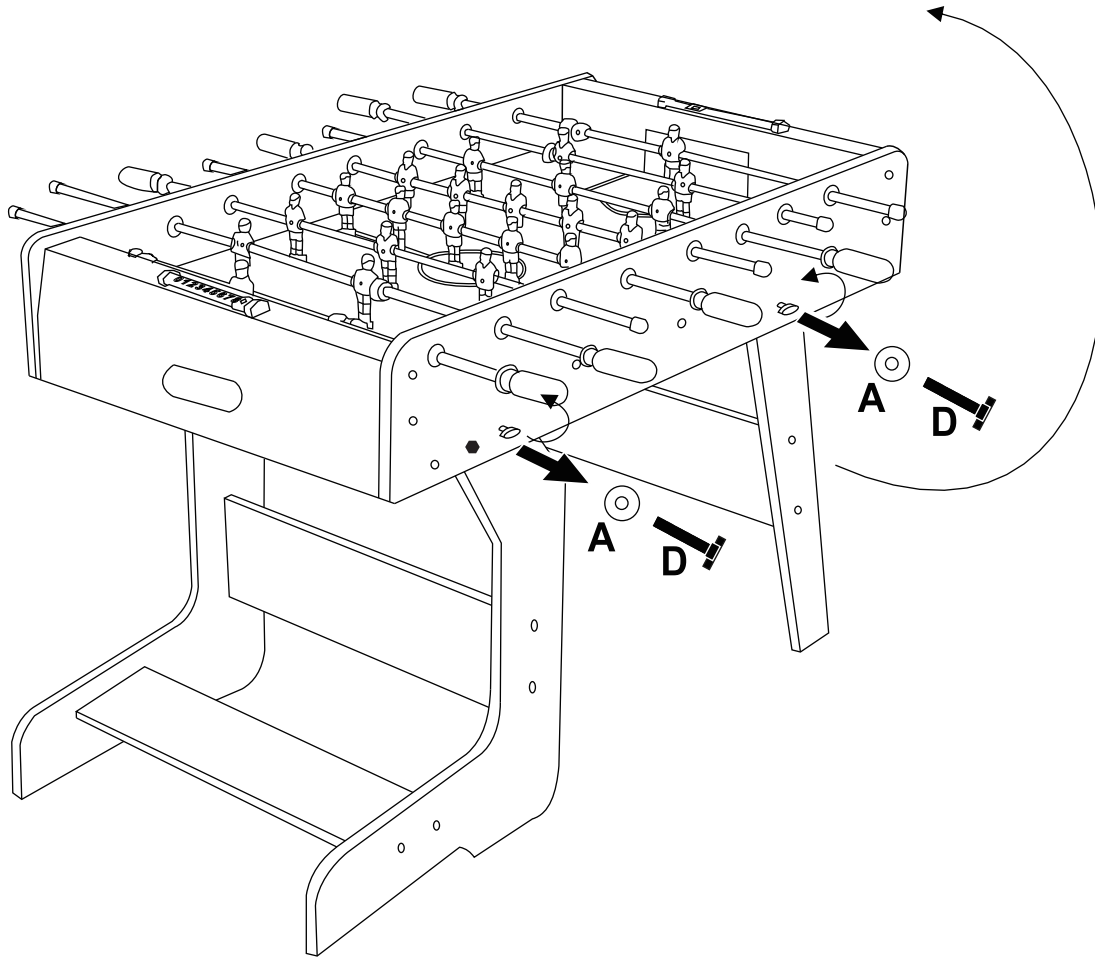

WARNING: THE GAME TABLE AGAINST WALL ON FLAT FLOOR AFTER BEING FOLDED!!!