







# Assembly Instructions









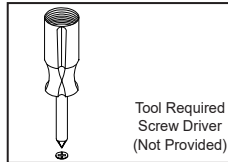

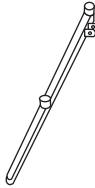
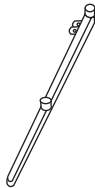
## 43034307 OVER THE WASHER UNIT

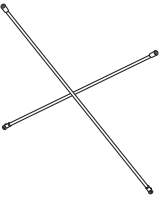
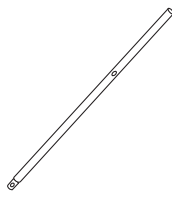
MAXIMUM TOTAL LOADING WEIGHT: 9KG (3KG FOR EACH SHELF, 3KG FOR HANG BAR).

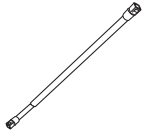
### Hardware list

	a	Plastics	2PCS		d	Plastics	1PC
	b	Long Screw	6PCS		e	Plastics	1PC
	c	Short Screw	2PCS		f	Gasket	2PCS

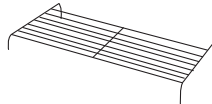

				
①	②	③	④	⑤
1PC	1PC	4PCS	1PC	4PCS
				
⑥	⑦	⑧	⑨	⑩
2PCS	2PCS	2PCS	1PC	1PC
				
⑪	⑫	⑬	⑭	
1PC	1PC	2PCS	1PC	

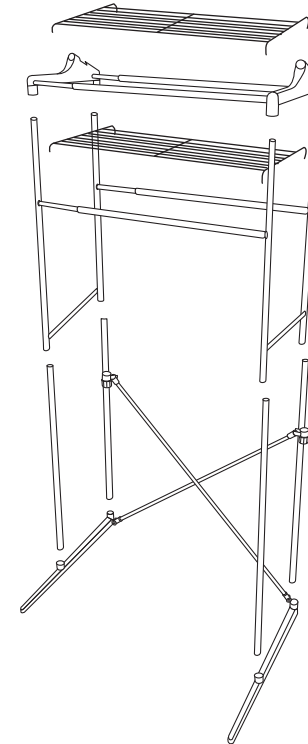

### STEP 1

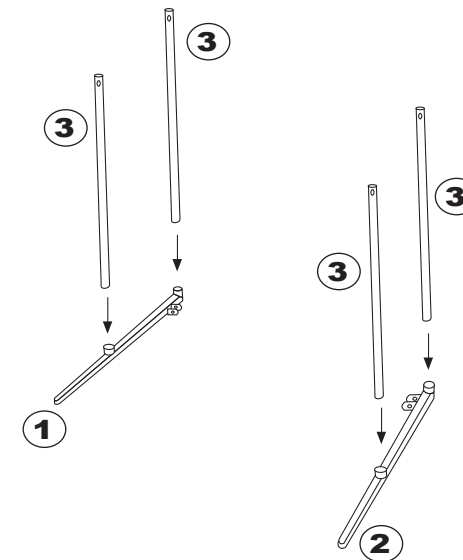

## STEP 2

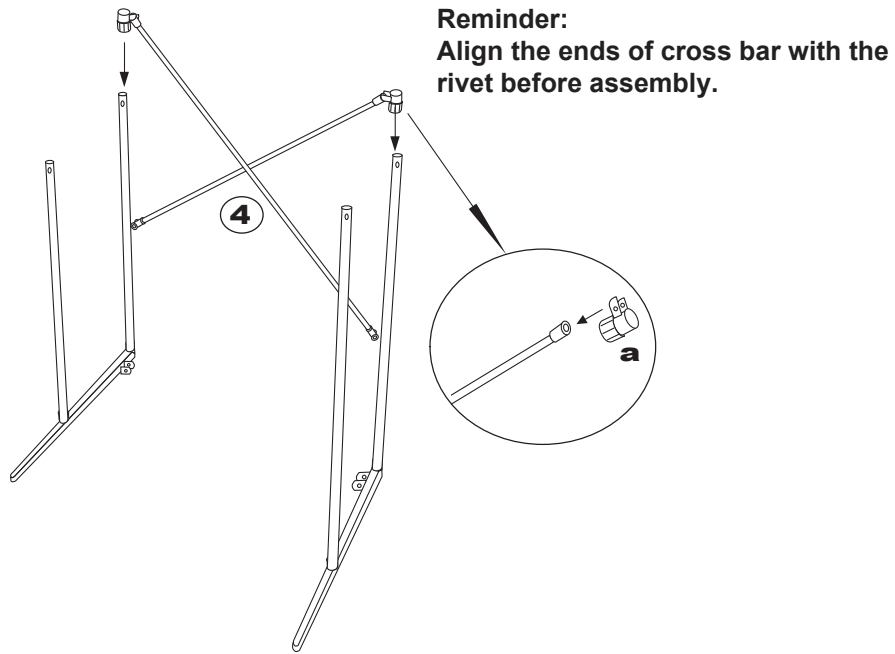

## STEP 3

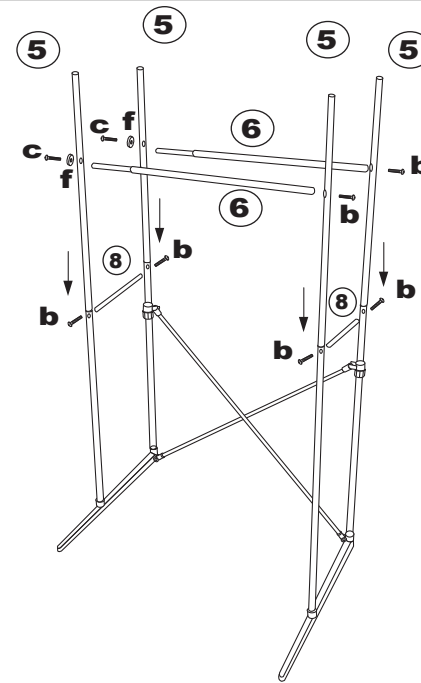

## STEP 4

Pre assembly by manufacturer:  
Align the socket (part 9, 10)  
with the buckle.

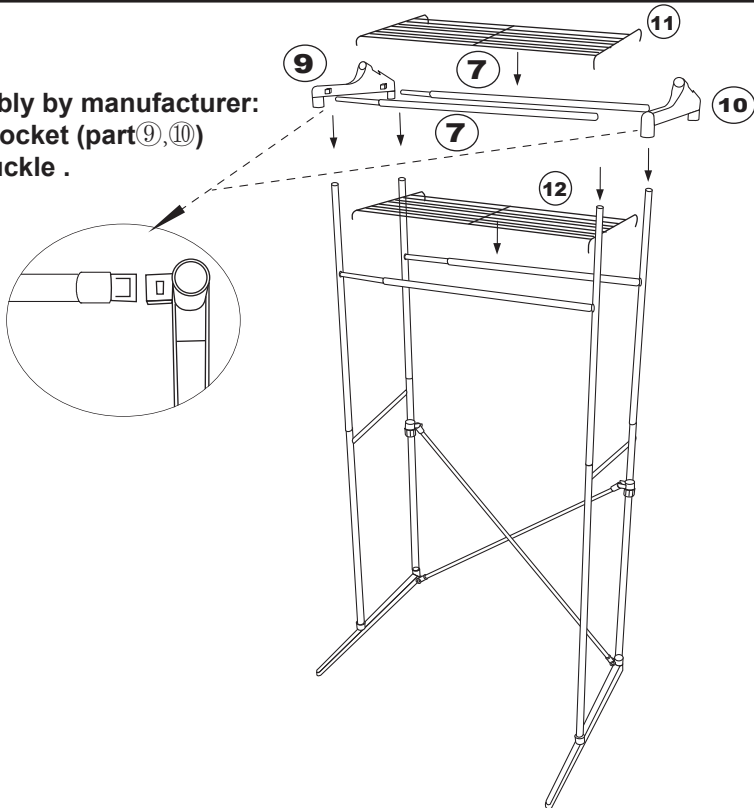

## STEP 5

