

Assembly Instructions

43036097 EGON WARDROBE WITH SHELVES







ATTENTION: DO NOT TIGHTEN THE SCREWS UNTIL THE PRODUCT IS FULLY ASSEMBLED.FOR INDOOR USE ONLY.

CARE INSTRUCTION: WIPE CLEAN WITH A SOFT DRY OR DAMP CLOTH. KEEP AWAY FROM WATER AND DIRECT SUNLIGHT. CHECK AND TIGHTEN ALL PARTS REGULARLY.





WARNING: DO NOT STAND OR SIT ON THE UNIT. DO NOT LEAN ON THE PRODUCT. DO NOT DRAG THE PRODUCT. USE ONLY ON A FLAT SURFACE. DO NOT USE UNTIL ALL SCREWS, BOLTS AND KNOBS ARE FIRMLY SECURED.THIS PRODUCT CONTAINS SMALL PARTS AND SHARP POINTS, KEEP AWAY FROM CHILDREN AND BABIES. ADULT ASSEMBLY REQUIRED. FAILURE TO FOLLOW THESE WARNINGS COULD RESULT IN SERIOUS INJURY.

MAXIMUM TOTAL LOADING WEIGHT: 46KG (10KG FOR CLOTHES RAIL AND 12KG FOR EACH SHELF)

1 Hardware list

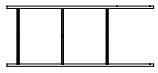
	a	M4x12mm	8pcs		e	2pcs
	b	M6x20mm	27pcs		f	2pcs
	c		4pcs		g	2pcs
	d	M4x40mm	2pcs			

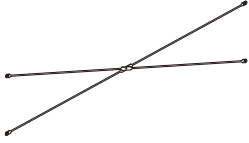
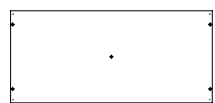
2

					
A	2PCS	B	2PCS	C	3PCS
					
D	1PC	E	1PC	F	3PCS
					
G	1PC				

3

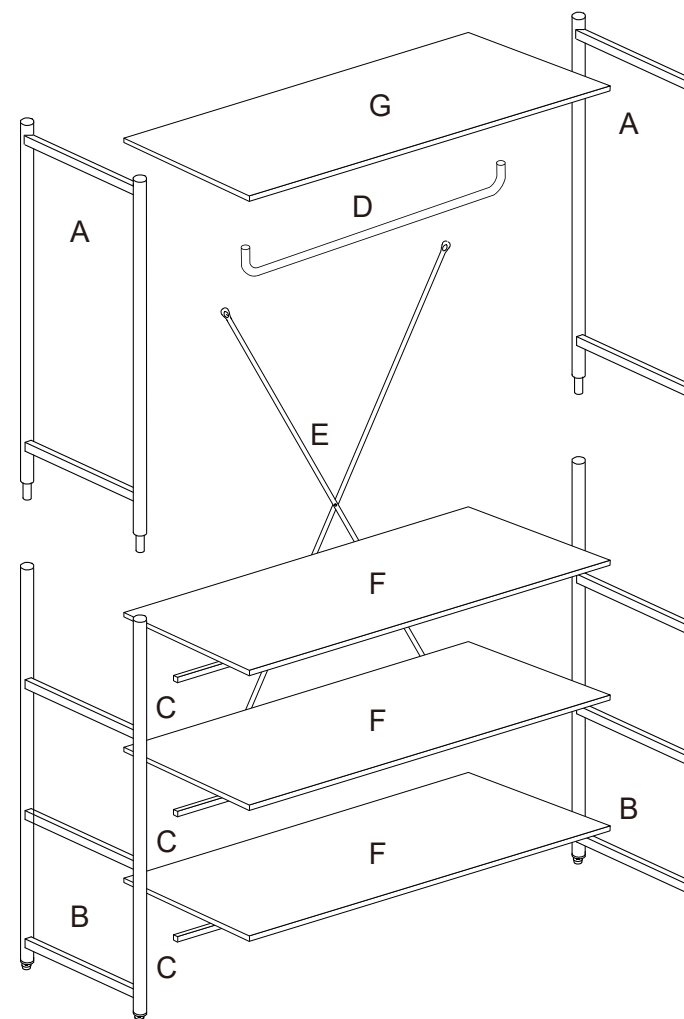

STEP 1

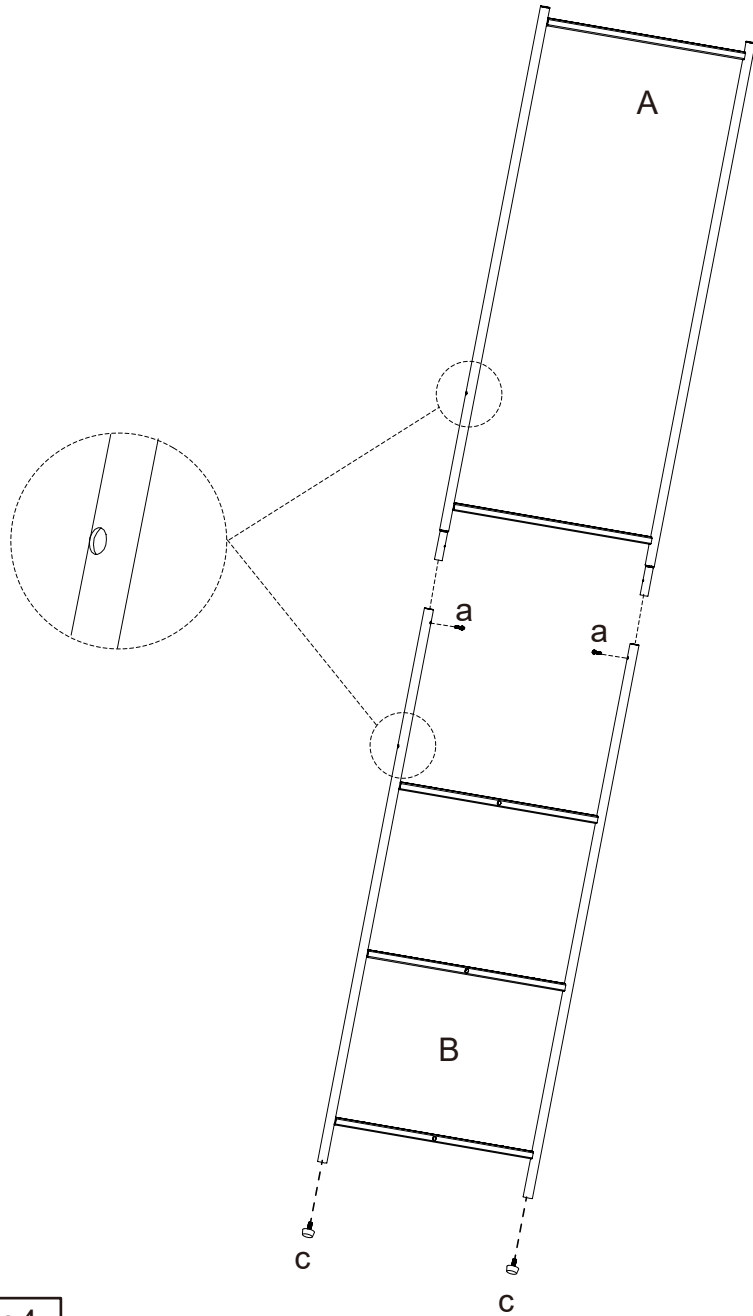

 a x 4

 c x 4

X 2

STEP 2

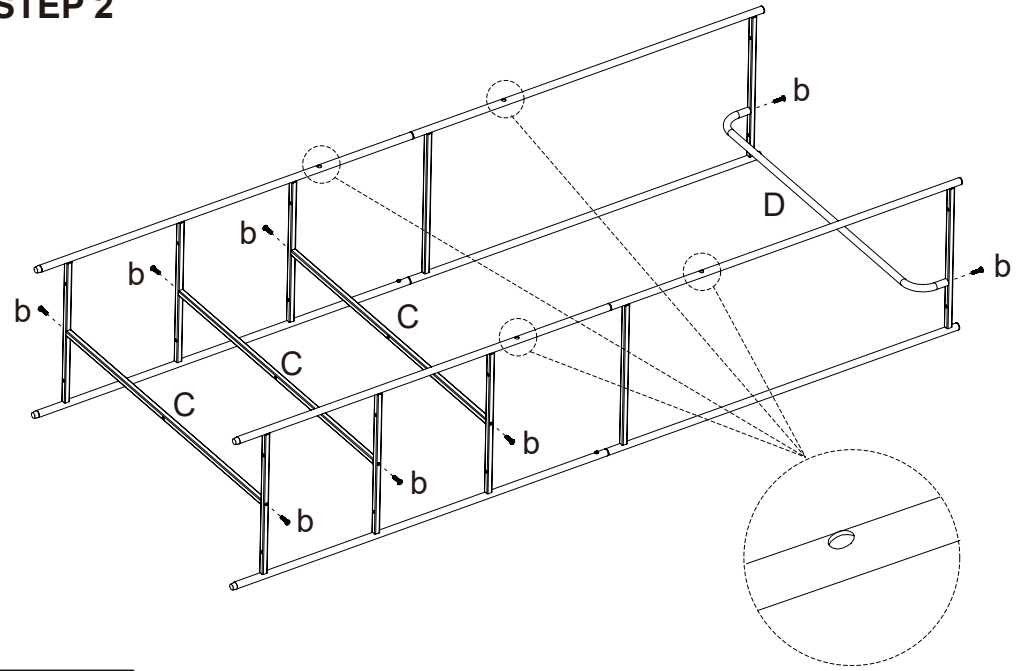

 b x 8

STEP 3

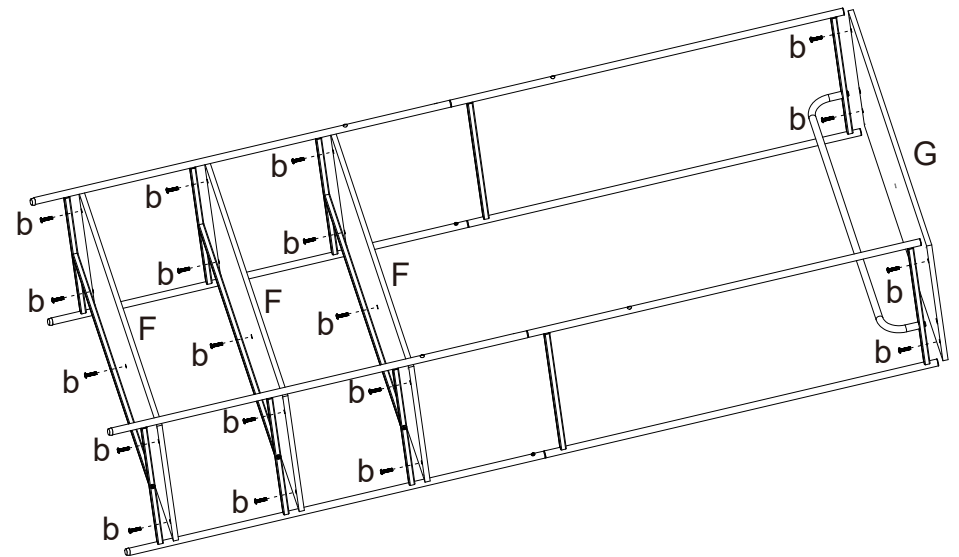

 b x 19

STEP 4

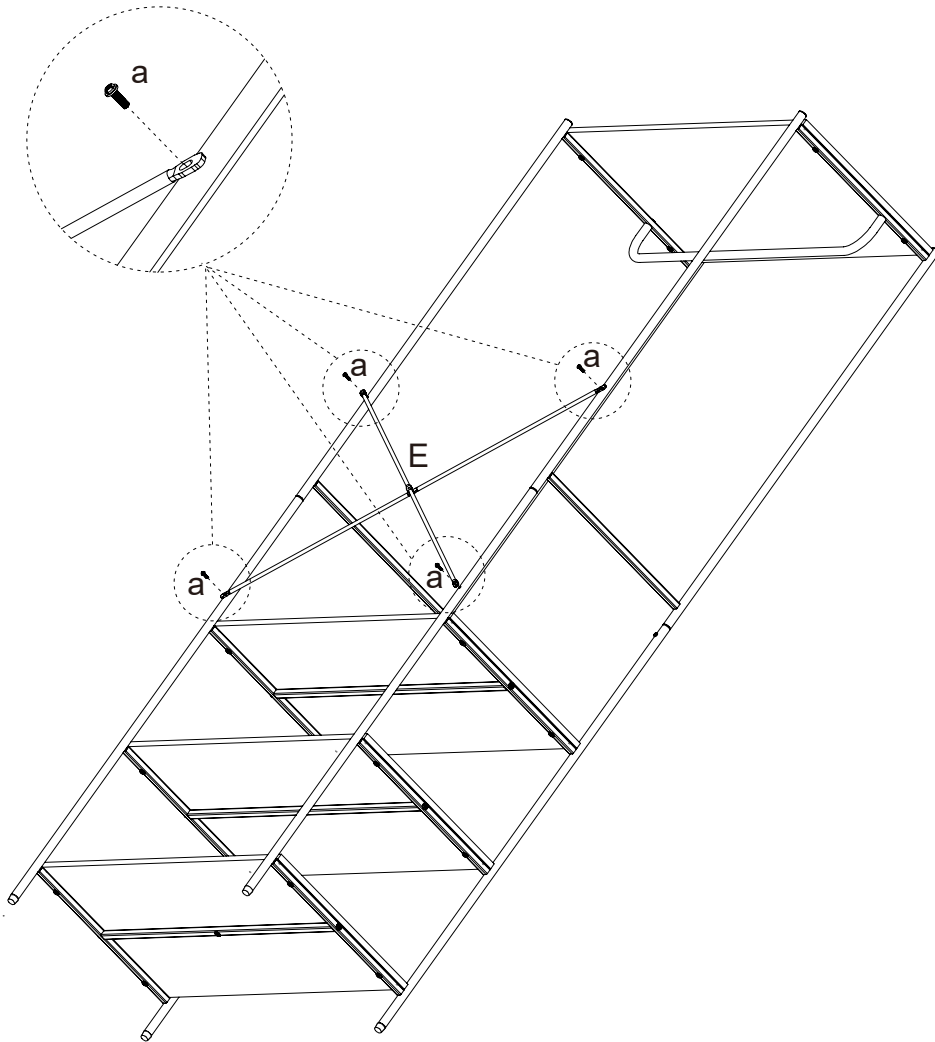

 a x 4

STEP 5

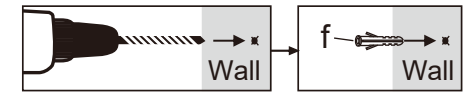



TOPPLING FURNITURE WARNING:

- >IT IS STRONGLY RECOMMENDED THAT THIS PRODUCT IS PERMANENTLY FIXED TO THE WALL.
- >PLEASE SEEK PROFESSIONAL ADVICE IF YOU ARE IN DOUBT OF WHAT FIXING DEVICE TO USE.
- >REGULARLY CHECK THAT ANCHORS ARE SECURELY MAINTAINED.
- >STABILITY OF TALL ITEMS MAY BE AFFECTED BY THICK PILE CARPET OR UNEVEN FLOORS.
- >DO NOT PLACE UNANCHORED TELEVISIONS ON FURNITURE.

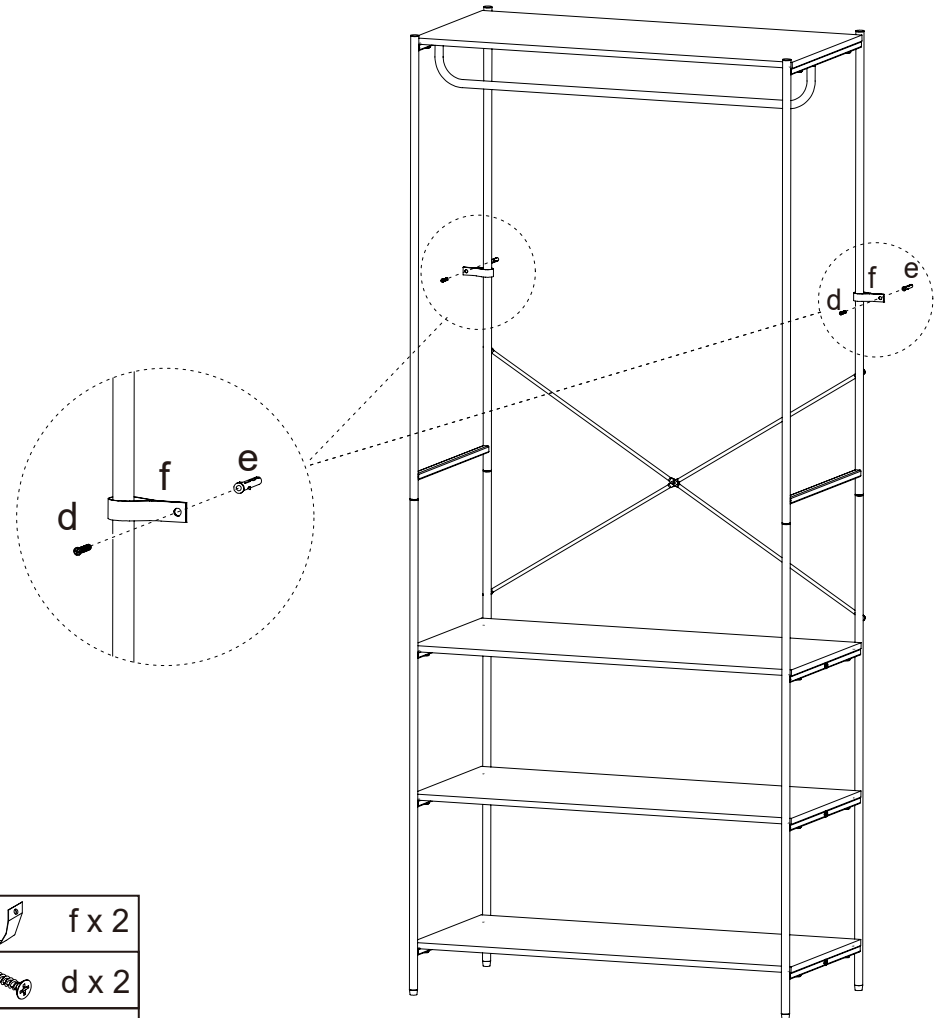
CAUTION: FOR YOUR SAFETY WHEN ATTACHING THE ANCHOR FIXINGS, PLEASE NOTE THE FOLLOWING:
>CHECK ANY ELECTRICAL WIRES OR PLUMBING INSIDE THE WALL BEFORE DRILLING ANY HOLES (IF YOU ARE UNSURE PLEASE SEEK PROFESSIONAL ADVICE FROM A QUALIFIED TRADESPERSON).



	f x 2
	d x 2
	e x 2