

anko

Instruction manual

Bluetooth® Party Ice Bucket Speaker

Keycode: 43067329

Features:



Safety Instructions:

Please read the instruction manual before using this device and follow all the safety instructions to avoid damage caused by improper use.

1. Keep the instruction manual for future reference. Should this appliance be given to a third party, then this instruction manual must also be handed over.
2. Use this appliance solely for its intended purpose.
3. This appliance is intended for household use only.
4. The manufacturer assumes no liability for possible damages that may have been caused by incorrect usage or mishandling of the appliance.
5. This appliance is not intended for use by persons (including children) with reduced physical, sensory or mental capabilities, or lack of experience and knowledge, unless they have been given supervision or instruction concerning use of the appliance by a person responsible for their safety.
6. Children should be supervised to ensure that they don't play with the appliance.
7. Before connecting the appliance to the mains supply, please check that the type of power and mains voltage match the information provided on the type plate.
8. Keep the appliance away from all hot surfaces and naked flames. Always put the appliance on a level, stable, clean, dry surface. Protect the appliance from extreme heat and cold, dust, direct sunlight, humidity and drops or jets of water.
9. The appliance is only suitable for use in temperate latitudes. Do not use it in the tropics climate or in humid climatic conditions.
10. Do not use the appliance if it is damaged. To avoid hazards, defective components must only be replaced by the manufacturer, his customer service or similar qualified persons.
11. Do not open the housing under any circumstances. Do not introduce any objects into the interior of the housing.
12. Do not immerse the appliance, power cord or power plug in water or in other liquids.
13. Do not place the appliance in the direct vicinity of liquids - e.g. bathtubs and sinks, in a damp basement or close to a swimming pool.
14. Do not charge the speaker in wet condition. Close the rubber cover when using the speaker.
15. Ice bucket for use with chilling only.

Package Include:

Bluetooth® speaker x 1
USB Charging cable x 1
User manual x 1

Specification

Bluetooth version 5.0
Speaker : 5W
Play time: up to 5 hours
Charge Voltage: DC5V 1A
Built-In Rechargeable Battery: 3.7V
IPX4

Bluetooth connection

If you have used Bluetooth connection before, as soon as you switch on your device, the system will start searching for the device last connected. When the device is found, it will re-connect automatically.

If you want to switch between devices, you have to turn off Bluetooth on the device last connected.

NOTE: Only one Bluetooth device can be connected to the remote control at one time.

First Bluetooth connection

1. Long press the power button 2-3 seconds to turn on the speaker. The blue LED indicator starts flashing.
2. Turn on Bluetooth on your smart phone. Refer to its user manual for instructions on pairing and connecting Bluetooth devices.
3. Select "KM43067329" from the device list.
4. The blue LED indicator stop flashing and stay on when connected successfully.

Product Overview

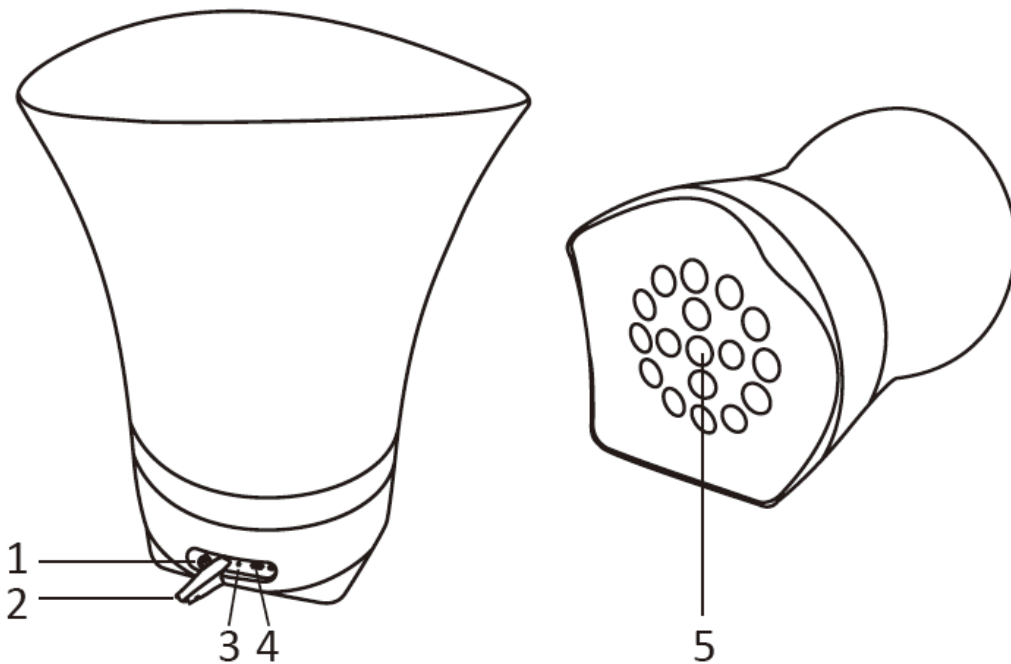

1	Power/LED light/Play/Pause Button	<ol style="list-style-type: none"> 1. Long press button to turn/off speaker. 2. Short press the button twice to different light modes. Slow rolling mode -> Fast rolling mode -> Breathing mode -> Fix color mode: Blue -> Red -> Green -> Purple -> Cyan -> Yellow -> White -> off. 3. Short press the button once to play or pause music.
2	Rubber cover	Rubber cover. Close the cover securely when filling ice or water.
3	LED indicator	<ol style="list-style-type: none"> 1. Blue LED flashing: waiting for Bluetooth connection.

		2. Blue LED stay on: Bluetooth connected. 3. Red LED on: Power connected.
4	Charging port	5V 1A
5	Speaker	5W Speaker

Use

1. Long press power button to turn on speaker.
2. Turn on your smartphone, make sure the Bluetooth connection is established and open your music app, play music on your device.
3. Choose desired light mode.
4. After use, long press power button to turn off speaker.

WARNING: THIS PRODUCT PRODUCES FLASH THAT MAY TRIGGER EPILEPSY IN SENSITISED INDIVIDUALS

12 Month Warranty

Thank you for your purchase from Kmart.

Kmart Australia Ltd warrants your new product to be free from defects in materials and workmanship for the period stated above, from the date of purchase, provided that the product is used in accordance with accompanying recommendations or instructions where provided. This warranty is in addition to your rights under the Australian Consumer Law.

Kmart will provide you with your choice of a refund, repair or exchange (where possible) for this product if it becomes defective within the warranty period. Kmart will bear the reasonable expense of claiming the warranty. This warranty will no longer apply where the defect is a result of alteration, accident, misuse, abuse or neglect.

Please retain your receipt as proof of purchase and contact our Customer Service Centre on 1800 124 125 (Australia) or 0800 945 995 (New Zealand) or alternatively, via Customer Help at [Kmart.com.au](https://www.kmart.com.au) for any difficulties with your product. Warranty claims and claims for expense incurred in returning this product can be addressed to our Customer Service Centre at 690 Springvale Rd, Mulgrave Vic 3170.

Our goods come with guarantees that cannot be excluded under the Australian Consumer Law. You are entitled to a replacement or refund for a major failure and compensation for any other reasonably foreseeable loss or damage. You are also entitled to have the goods repaired or replaced if the goods fail to be of acceptable quality and the failure does not amount to a major failure.

For New Zealand customers, this warranty is in addition to statutory rights observed under New Zealand legislation.