

anko

Cat Tower XL

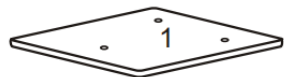

Contents



1PC SIZE 480mm*480mm*12mm

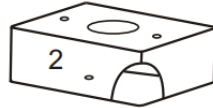

1PC SIZE 480mm*300mm*240mm

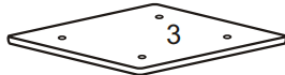

1PC SIZE 480mm*480mm*12mm



2PC SIZE 280mm*280mm*12mm

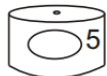

1PC SIZE 280mm*280mm*240mm

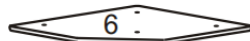

1PC SIZE 480mm*480mm*12mm



2PC SIZE 300mm*300mm*70mm



1PC

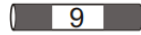

2PC SIZE \varnothing 67mm*480mm



2PC SIZE \varnothing 67mm*480mm



2PC SIZE \varnothing 67mm*100mm

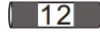

4PC SIZE \varnothing 67mm*240mm

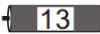

1PC SIZE \varnothing 67mm*240mm

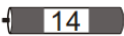

1PC SIZE \varnothing 67mm*400mm

| Accessory | Size | Quantity |
|-----------|----------|----------|
| A | 8mm*35mm | 4pcs |
| B | 8mm*27mm | 2pcs |
| C | 8mm*70mm | 8pcs |
| | 5MM | 1pc |

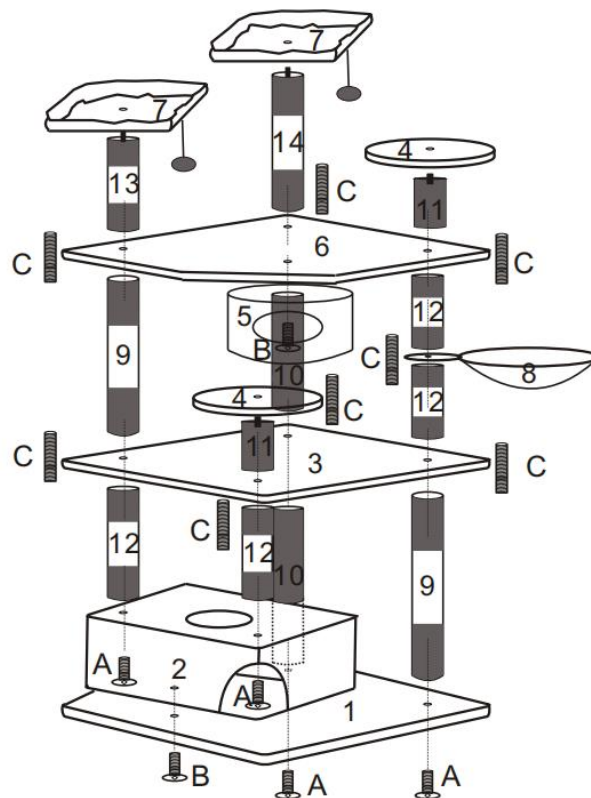

Instructions

Step 1.

Screw the bottom board (No.1 x1) to the cat house (No.2 x1) using the hex key and screw (B x 1). Screw the two poles (No.9 x 1 & No.10 x 1) into the bottom board using the hex key and screws (A x 2). Insert the screws (C x 2) into the top of the poles (No.9 x 1 & No.10 x 1).

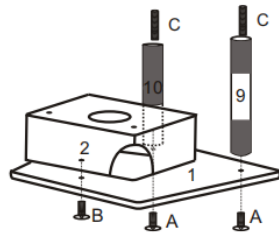

Step 2.

Screw poles (No.12 x 2) into the cat house (No.2 x 1) using the hex key and screws (A x 2). Insert the screws (C x 2) into poles (No.12 x 2).

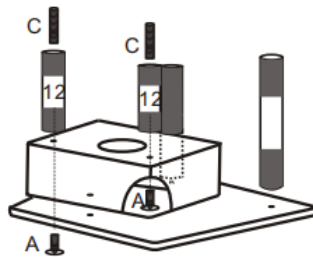

Step 3.

Place the middle board (No.3 x 1) on. Screw the four poles (No.9 x 1 & No.10 x 1 & No.11 x 1 & No.12 x 1) on screw C, then insert the screws (C x 3) into poles (No.9 x 1 & No.10 x 1 & No.12 x 1). Refer to the image below.

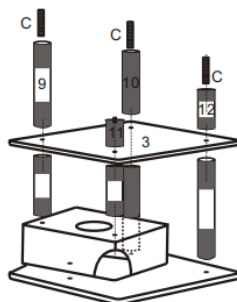

Step 4.

Screw round board (No.4 x 1) on screw C. Put the middle pet bed (No.8 x 1) on pole (No.12 x 1), screw pole (No.12 x 1) on screw C, insert the screw (C x 1) into pole (No.12 x 1).

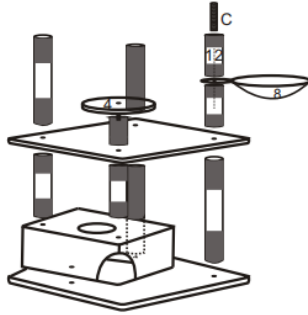

Step 5.

Put the top board (No.6 x 1) on. Screw three poles (No.11 x 1 & No.13 x 1 & No.14 x 1) on screw C as shown below.

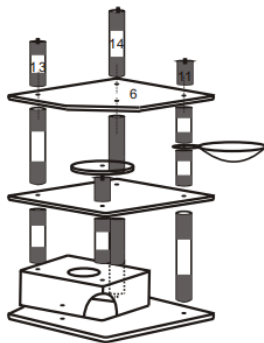

Step 6.

Put the top board (No.6 x 1) on. Screw top square pet bed (No.7 x 2) on poles (No.13 x 1 & No.14 x 1), screw round board (No.4 x 1) on pole (No.11 x 1). Using the Hex key and screw (B x 1) to screw top board (No.6 x 1) together with the round cat house (No.5 x 1).

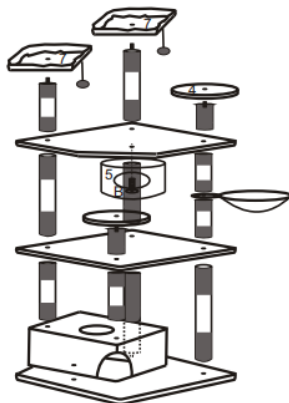

WARNING: Pet toy – Not intended for children.

It is the responsibility of the pet owner if this toy is suitable for their pet's style of play.

No pet toy is indestructible and can be damaged during play.

For your pet's safety, inspect regularly and remove if damaged.

Always supervise your pet during play.