

# 43073436 90CM NEST SWING SEAT

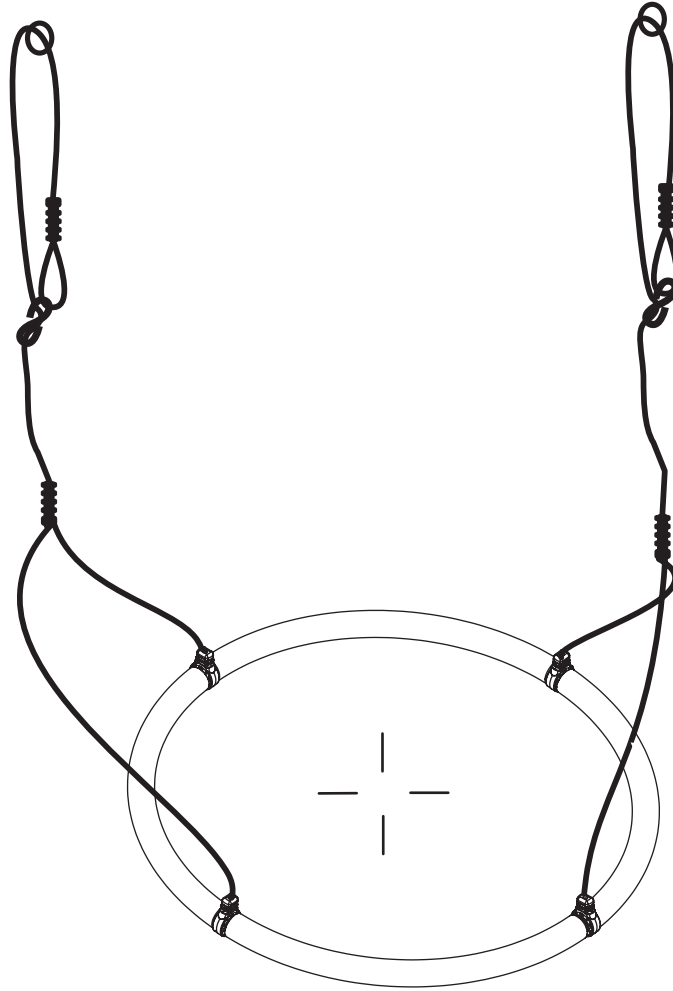

## WARNING!



This must be assembled by an adult before use.

This product contains small parts and is not suitable for children under 36 months.

Children must not use the equipment until properly installed. Adult Supervision is recommended.

Only for domestic use. For outdoor use and indoor use.

Check all fastenings regularly and often. Failure to do this way result in the product malfunctioning, and causing injury.

Suitable for children 3+ years of age. Maximum user weight 100KGS.

Designed to be used for 1 child only.

Danger of falling. Strangulation hazard.

Never stand or kneel on the swing, always hold yourself firmly with both hands

Make sure that you have a safety clearance of at least 2 m (front and back) beyond the maximum reach of the swing and make sure the ground is level and shock absorbing (e.g.grass) without any sharp edges or pointed objects,obstacles, inclines,levels,steps or hard surface (e.g.concrete) etc.

Storing in a dry location when not in use will help to extend the life of your swing.

## INSTRUCTIONS ON ASSEMBLY AND USE



### CONGRATULATIONS ON PURCHASING THIS PRODUCT!

Please read these instructions carefully. The instructions are an integral component of the product. Therefore, please store them and the packaging carefully in case questions arise in the future. Please always include these instructions when handing on the product to a third party. This product must be assembled by an adult. This product is designed for domestic use only. This product is not designed for commercial / industrial use. The use of the product requires certain capabilities and skills. Always adjust according to the age of the user and use for the purpose it has been designed for.

### SAFETY INSTRUCTION

- **WARNING!** Only for domestic use.
- **WARNING!** To be used under the direct supervision of an adult.
- **WARNING!** Not suitable for children under 36 months. Danger of falling!
- **WARNING!** Not suitable for children under 36 months. Long cord. Strangulation hazard. Small parts. Choking hazard.
- **WARNING!** Suitable for outdoor and indoor use!
- The owners of the swing as well as the competent supervisory personnel are responsible for ensuring that all users follow the instructions in the operation manual.
- Do not make any technical modifications.
- Changes to the original product must only be carried out according to manufacturer specifications.
- No one is permitted to gain access to the swing area during use.
- Never stand or kneel on the swing.
- Always hold yourself firmly with both hands.
- No objects of any kind must be in the vicinity of the swing zone (trees, walls, fences, clotheslines).
- Check nest seat fabric and rope for extreme heat before letting children use nest seat. (When exposed to direct sunlight)
- Clearance to stationary components on the side, such as the swing scaffolding must be at least 40 cm.
- Swinging components, such as a neighboring swing must be placed at a distance of at least 60 cm.
- Maximum raised height must not exceed 2.5 meter as measured from the ground.
- In idle mode, the swing must be at least 40 cm and maximally 60 cm from the ground.
- You should never install a swing in such a way that the user could be blinded by sun rays.
- When permanently exposed to UV light, the material ages significantly faster. To avoid premature aging and thereby extend the service life, you should always store the product in a dry and dark place when not in use. Do not permanently expose the product to wind, moisture, extreme temperatures or sunlight.

### INSTRUCTIONS ON ASSEMBLY

Prior to installation, carefully select and check the location where you will install the swing. Place the activity toy on a level surface at least 2.5m from any structure or obstruction such as a fence, garage, house, overhanging branches, laundry lines or electrical wire. Please make sure that the swing carrier is adequately stable. Please take into account that swinging produces centrifugal forces that can put a lot of strain on the swing carrier. Please consult an expert (statics expert, architect, carpenter) and ask how much load your swing carrier can tolerate. Suspension connectors shall be of a design that will prevent unintentional disconnection. After removing the product from its packaging, please check it for completeness.

### HANGING DEVICE AND ADJUSTMENT

The hanging points must be at least as far apart as the swing seat + 100mm. The swing is packaged with two ropes and adjustment eyelet ring, so that the height of the swing can be variably aligned with any suitable hanging device. The swing rope (3) can be lengthened or shortened by pushing or pulling it through the adjustment rope loops. The hanging swing can now be individually adjusted. No one should sit on the swing while making the adjustments. When extending or reducing the length of the swing ropes please make sure that the ropes remain equally long at all times. If the lengths of the ropes differ, this will lead to circular pendulum movements of the swing. Make sure that swing is set up in such a way that the person using the swing cannot reach the ground with the tips of his or her toes. If in doubt, perform a few gentle test swings.

### MAINTENANCE AND STORAGE

Use a dry or damp cloth only to clean the product; do not use special cleaning agents! Check the product for damage or traces of wear and tear before and after each use. If checks are not carried out this may lead to a hazard. Do not make any structural changes. If parts become damaged or if sharp edges or corners should develop, the product may not be used any more. Please replace damaged parts when necessary. Store the product in a safe place where it is protected from the elements, cannot be damaged, and cannot injure anyone.

Check the product for damage or traces of wear and tear before and after each use.

We also recommend before each use:

- to check for the firm sitting of nuts and bolts and plastic suspensions, tighten if necessary
- to lubricate moving parts in order to minimize wear.
- to check all covers of screws and sharp edges and replace if necessary
- to replace defective parts according to the manufacturer's instructions
- to check swing seats, chains, ropes and other means of attachments for evidence of deterioration
- Sand rusted areas and tubular members and repaint using a non-lead based paint when required

Please keep instruction manual for future reference, and it is important that instruction manual is followed at the beginning of each season as well as at regular intervals during usage season.

Kmart

Kmart Australia limited

Kmart Australia-690 Springvale Rd, Mulgrave,

VIC 3170 Australia.

Tel: 1800 124 125

Kmart New Zealand -Regional office

C/O Kmart Papatoetoe Store

Hunters Plaza, Great South Rd, Papatoetoe,

Auckland, New Zealand.

Tel: 0800 945 995

Made in China

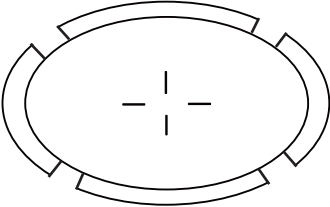
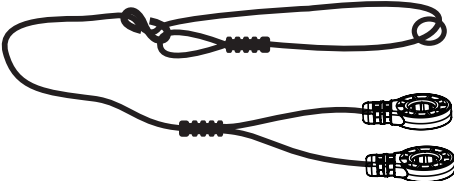
PART #	PART DESCRIPTION	QTY
1	 A curved, U-shaped tube with small rectangular protrusions at each end.	x4
2	 An oval-shaped cloth with a central crosshair and four small tabs around the perimeter.	x1
3	 Two ropes. One is a single loop with a knot and a small cylindrical component. The other is a double-strand rope with two cylindrical components at the ends.	x2

## Step 1: Seat cloth assembly

Make the nest seat tube go through the sleeve tunnel of seat cloth, repeat this step for 4 times.

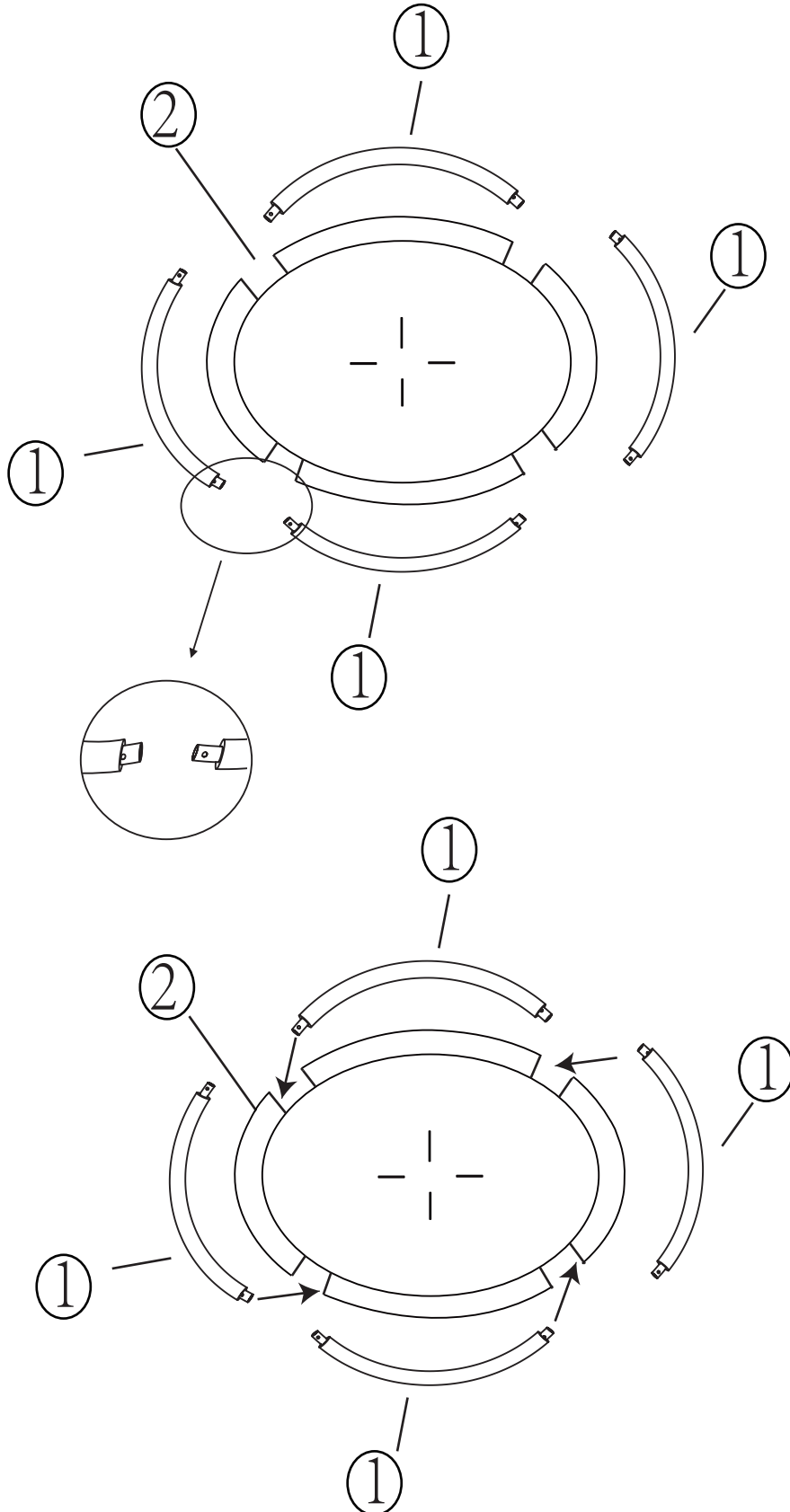

## Step 2: Nest seat tube assembly

Make one nest seat tube end go through the rope plastic suspension and connect to end of another tube by clip the pit pin, repeat this step for 4 times to finish tube assembly.

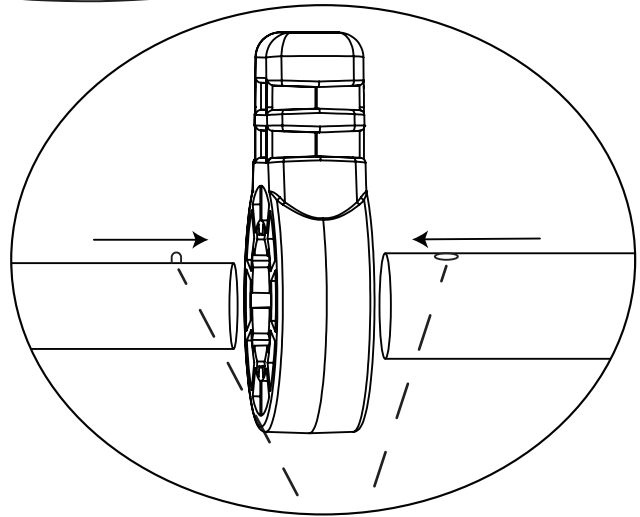
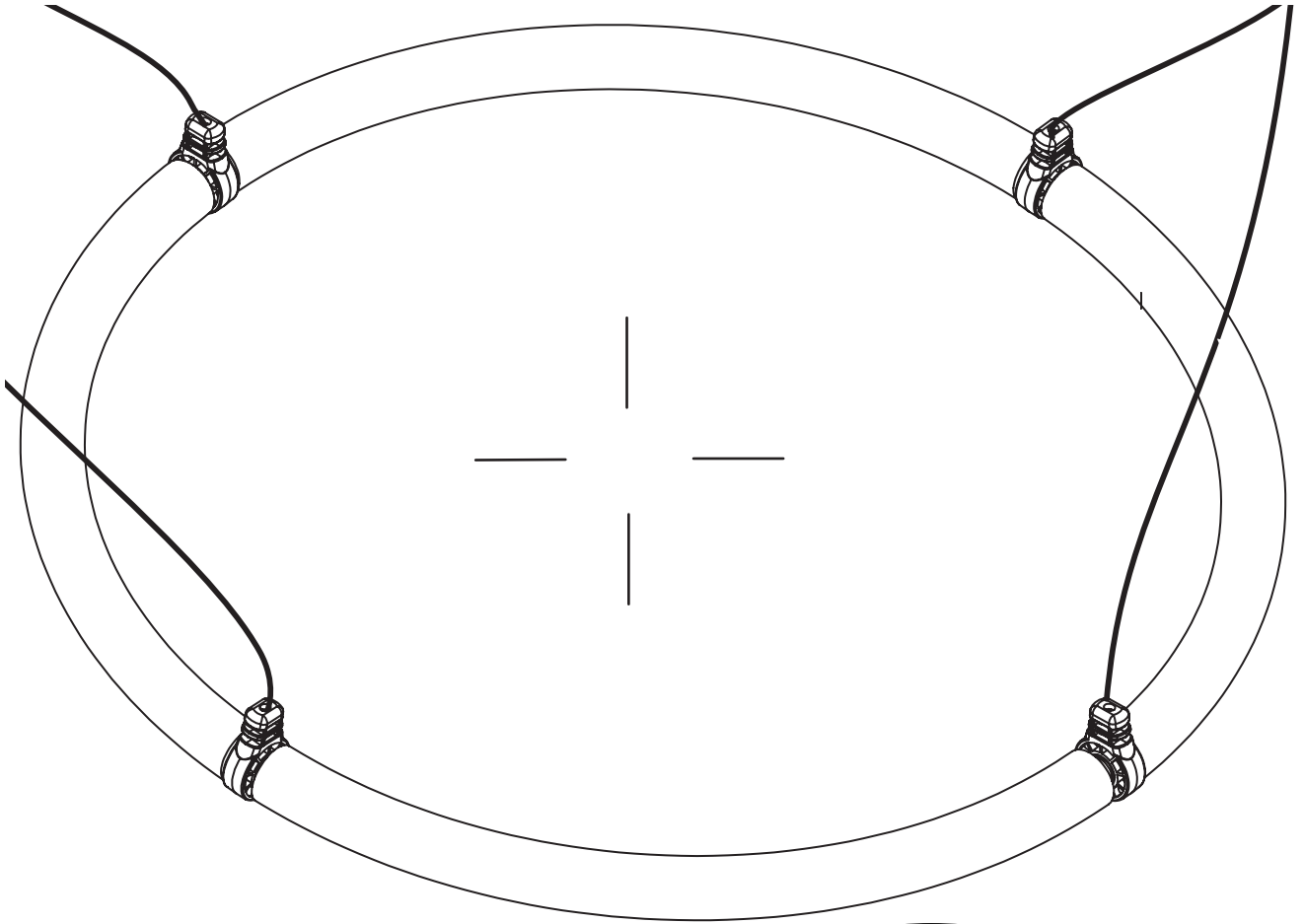

### Step 3: Nest swing assembly on the swing set or stable structure

Attach whole nest swing only to swing set or stable structure (not included)(trees not allowed) top bar by screwing the O ring on the ropes to the U hook. Make sure to follow below requests on swinging zone for safety purpose:

- Make sure that you have a safety clearance of at least 2 m (front and back) beyond the maximum reach of the swing and make sure the ground is level and shock absorbing (e.g.grass) without any sharp edges or pointed objects,obstacles, inclines,levels,steps or hard surface (e.g.concrete) etc.
- No objects of any kind must be in the vicinity of the swing zone (trees, walls, fences, clotheslines). Obstacles, inclines, levels, steps or hard surfaces (e.g. concrete) etc.
- Clearance to stationary components on the side, such as the swing scaffolding must be at least 40 cm.
- Swinging components, such as a neighboring swing must be placed at a distance of at least 60 cm.
- Maximum raised height must not exceed 2.5 meters as measured from the ground.
- In the mode, the swing must be at least 40 cm and maximally 60 cm from the ground.

