

anko

2 in 1 Rechargeable Detail Trimmer User Manual



Model No.: MR-8877
Rev 1

Note: The specifications and/or components of this appliance are subject to change without prior notice.

1	Safety Instructions	3
2	Components	6
3	Instructions for Use	6
3.1	Charging the Appliance	6
4	Operation	7
4.1	Hair Trimmer	7
4.2	Nose Trimmer	8
5	Care and Cleaning	9
5.1	Cleaning the Trimmer and Nose Trimmer.....	9
5.2	Cleaning the Combs.....	10
5.3	Lubrication.....	10
6	Storage	10
7	Technical Specifications	10
8	Warranty Against Defect	11

1 Safety Instructions

When using electrical appliances, basic safety precautions should always be followed, including the following:



Carefully read this instruction manual before using the appliance and USB cable.

- Keep the appliance, accessories and USB cable out of reach of young children.
- This appliance is not intended for use by persons (including children) with reduced physical, sensory or mental capabilities, or lack of experience and knowledge unless they have been given supervision or instruction concerning use of the appliance by a person responsible for their safety.
- Children should be supervised to ensure that they do not play with the Appliance and/or USB cable.
- Ensure children and babies do not play with plastic bags or any packaging materials.
- To protect against the risk of electric shock, do not immerse the appliance, cord or charger in water or other liquids.
- DO NOT use or store the product near sinks, baths or showers containing water or near running water.
- DO NOT use in the bath, shower, spa. pool etc.
- Do not disassemble the Appliance and/or USB cable. There are no user-serviceable parts inside.
- **VERY IMPORTANT:**
Ensure that the charger (not supplied) and/or USB cable does not get wet (water splashes etc.).
- Do not use your charger or the USB cable with wet hands.
- Only Charge the Appliance with the USB cable that was supplied with the Appliance.
- Only Charge the Appliance from an Extra Low Voltage Battery Charger (not supplied) with an output rating the same as indicated on the Appliance's rating label.
- Position the USB cable properly so that they will not be walked on or pinched by items placed on or against them.
- Use the Appliance, accessories and USB cable only for its intended use. The Appliance, accessories and USB cable are intended for household use only and not for commercial or industrial use.

- Inspect the USB cable, Appliance and accessories for damage before every use.
- Do not use the appliance if it has been dropped or any part of the Appliance, accessories and/or the USB cable has been damaged.
- If the USB cable is damaged, call our customer service for a replacement.
- The use of accessories not intended for use with this Appliance may cause injuries to the user or damage to the Appliance, components and/or the USB cable.
- Do not sit the Appliance on other appliances, on uneven surfaces or where it could be subject to heat sources (e.g., radiators or stoves), direct sunlight, excessive dust or mechanical vibrations.

The Appliance and/or USB cable must not be used outdoors if raining, near water, placed near a hot gas or electrical burner or placed in a heated oven.

- Do not place or leave near any heat sources such as radiators, heat registers, stoves, or other apparatus that produce heat.
- Do not operate or charge the Appliance underneath or near flammable or combustible materials (e.g., curtains).
- Always switch off and unplug the USB charger cable when finished charging the appliance, or during lightning storms or when unused for long periods.
- Do not cover the appliance or charger when charging or when in use.
- Turn off and unplug before cleaning or storing.
- Any type of servicing, apart from ordinary cleaning, must be carried out by a qualified electrical person only. There are no user-serviceable parts in this Appliance or USB cable.
- Cleaning and user maintenance shall not be made by children without supervision.
- If this Appliance and USB cable is used by a third party, please supply the instruction manual with it.
- Do not misuse the USB cable. Never carry the Appliance by the USB cable or pull to disconnect it from the socket. Instead, grasp the plug and pull to disconnect.
- Do not insert or allow foreign objects to enter any openings as this may cause damage to the Appliance and/or injury to the user.
- Do not leave the Appliance running or charging unattended.

- No liability can be accepted for any damage caused by non-compliance with these instructions or any other improper use or mishandling of the Appliance, charging base and/or USB cable.
- This product has not been designed for any uses other than those specified in this manual.
- **ONLY** for domestic use. Industrial or commercial use invalidates the warranty.



WARNING

Only use the USB cable that was supplied with this Appliance.

Consumers are cautioned against trying to replace the battery. Using and/or purchasing counterfeit and/or inferior quality batteries have the potential to cause fire, personal injury, and/or damage to property. These batteries are typically found on online-auction websites or from other retailers and are known to pose a potential safety risk.

Never try to charge non-rechargeable batteries as they may explode or catch on fire or cause personal injury and/or damage to property.

- Batteries may explode if disposed of in fire.
- The battery is not replaceable. Do Not open the appliance.
- Do not use or store in temperatures above 40°C



At the end of the appliance's life, it must be disposed of correctly.

Contact your local waste management authority for more information on Battery Recycling and disposal regulations in your area.

Do not dispose of electrical appliances or batteries as unsorted municipal waste, use separate collection facilities. Contact your local council for information regarding the collection systems available. If electrical appliances are disposed of in landfills or dumps, hazardous substances can leak into the groundwater and get into the food chain, damaging your health and well-being. Please contact your local council or regional authority for more information on the collection, reuse, and recycling programmes.

Read and Save These Instructions

2 Components

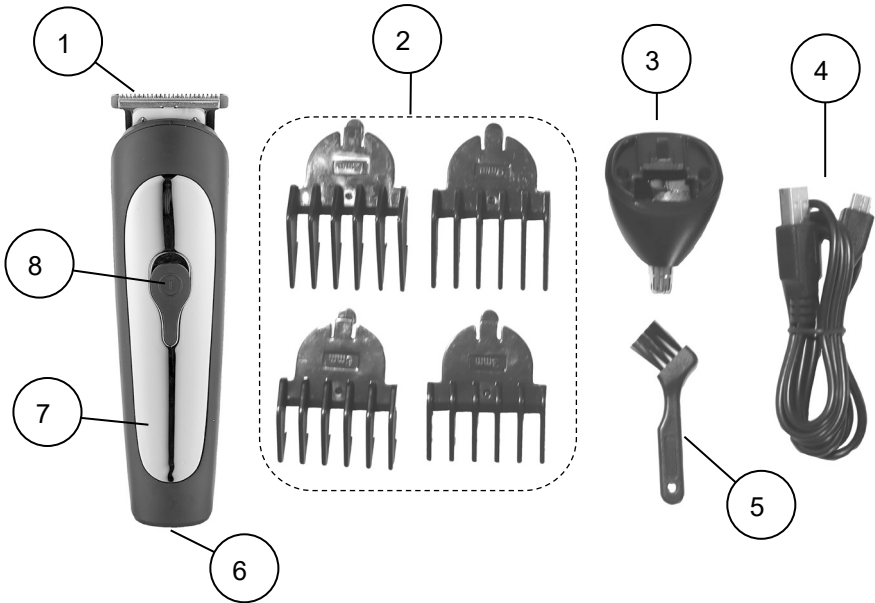

1	Hair Trimmer	5	Cleaning Brush
2	Height Combs	6	Charging port
3	Nose Hair Trimmer	7	Charging indicator
4	USB Cable	8	On / Off Slide Switch

3 Instructions for Use

3.1 Charging the Appliance

Read the Safety Instruction first.

IMPORTANT: This Appliance contains a built-in lithium-ion battery which must only be charged using the supplied USB cable.

Always switch off and unplug the USB cable when charging is completed or when not in use.

DO NOT allow to charge for more than 12 hours.

Normal charge takes approximately 2 hours



If any abnormality occurs during charging, (such as a burning smell or excessive heat or even a strange sound) immediately turn off the charger and disconnect the USB cable, then contact our service department for assistance.

IMPORTANT: The Appliance must be fully charged before first use.

- Take the USB Cable and fully unravel it before using it to charge the Appliance.
- Plug the small end of the USB cable directly into the bottom of the appliance.

Note: This small plug can only be inserted in one direction. If you cannot push the plug in, rotate it 180° and then try again.



- Plug the large end of the USB cable into your 5Vd.c. 1A USB charger (not supplied) and switch on.
- A Red “” symbol will illuminate indicating the battery is charging.
- When fully charged, the Red “” symbol will turn off and a Blue “Battery” Symbol will illuminate.

Note: During use, the Blue “Battery” Symbol will illuminate and will then change to a flashing red “” Symbol when the battery needs recharging.

4 Operation

4.1 Hair Trimmer

The appliance comes with a Hair Trimmer attachment along with various height comb attachments for varying the trim height.

This attachment can be used for trimming sideburns, moustaches, beards, eyebrows, neck hair, etc.

You can attach any of the Height Combs that you require.

- To do this, hook the comb over the front of the trimmer then rotate backwards, then push down on the back of the comb until it clicks in place.

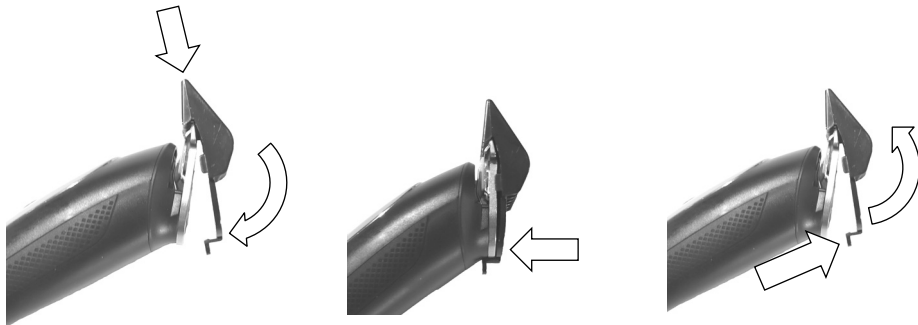

- To remove, lift up the small tab and swing up and forward.
- To use the Trimmer:

Once the desired hair trimmer Comb size (item 2) is fitted, slide the On / Off switch upward to turn On, then in a scooping motion move the comb through the hair against the growth of hair working your way slowing so as not to snag or pull when cutting longer hair.

When cutting hair on the top of your head work from front to back in a similar motion.

When finished slide the On / Off switch down to turn the unit off.

4.2 Nose Trimmer

The appliance comes with a Nose Hair Trimmer attachment.

This attachment can be used for trimming the protruding hairs from your nostrils.

- To attach, first remove the trimmer head attachment by grasping the appliance body with one hand, then grasp the front of the trimmer head and then whilst pulling the front down in a rotating motion, unclip the trimmer head.

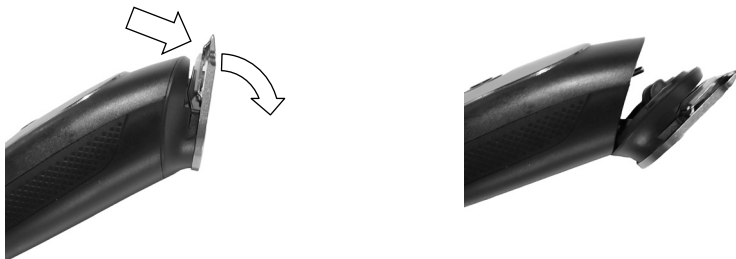

To fit the Nose Trimmer attachment, align the hook into the main body then whilst pushing in, swing up the Nose trimmer attachment and push in until it clicks in place.

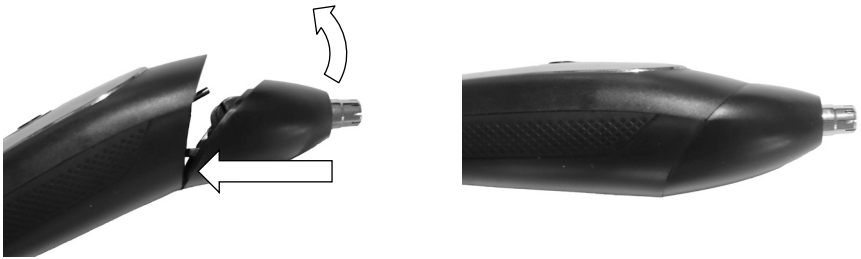

- To use the Nose Trimmer:

Once the Nose Trimmer attachment (3) is fitted slide the On / Off switch upward, then gently place the nose trimmer into one nostril and work in a circular motion around the internal area of the nostril cavity.

CAUTION: Be very careful not to push the trimmer too far up into the nasal cavity as this may become uncomfortable.

Once finished, turn the unit off by sliding the On / Off switch down, check and clean the nose trimmer attachment if necessary and repeat the same procedure on the other nostril.

5 Care and Cleaning

5.1 Cleaning the Trimmer and Nose Trimmer

To ensure optimal trimming efficiency, the trimmer must be cleaned regularly.

IMPORTANT: Do Not use flammable liquids, chemicals, abrasive creams, steel wool or scouring pads for cleaning.

The easiest way to clean the trimmer is to brush off the hairs with the small cleaning brush.

DO NOT use water or any other liquids to clean.

5.2 Cleaning the Combs

- The Combs can be cleaned using a mild detergent and warm water.
- Rinse off in clean water and dry thoroughly before use.

NOTE: Cleaning and user maintenance shall not be made by children without supervision

5.3 Lubrication

The Hair Trimmer will need periodic lubrication to allow the blades to run smoothly.

Use a drop of sewing machine oil every few months of use directly onto the trimming blades.

6 Storage

- Switch off and unplug the appliance.
- Coil the USB cable loosely. Do not kink or pull the cable tight.
- Ensure all parts are completely dry.
- Store your appliance and accessories in a cool, dry location

7 Technical Specifications

Input: 5Vd.c. 1A

Battery Type: Li-ion 3.7V 600mAh

Charge Time: approx. 2hr

Working Time: approx. 1hr

8 Warranty Against Defect

12 Month Warranty

Thank you for your purchase from Kmart.

Kmart Australia Ltd warrants your new product to be free from defects in materials and workmanship for the period stated above, from the date of purchase, provided that the product is used in accordance with accompanying recommendations or instructions where provided. This warranty is in addition to your rights under the Australian Consumer Law.

Kmart will provide you with your choice of a refund, repair or exchange (where possible) for this product if it becomes defective within the warranty period. Kmart will bear the reasonable expense of claiming the warranty. This warranty will no longer apply where the defect is a result of alteration, accident, misuse, abuse or neglect.

Please retain your receipt as proof of purchase and contact our Customer Service Centre 1800 124 125 (Australia) or 0800 945 995 (New Zealand) or alternatively, via Customer Help at Kmart.com.au for any difficulties with your product. Warranty claims and claims for expenses incurred in returning this product can be addressed to our Customer Service Centre at 690 Springvale Rd, Mulgrave Vic 3170.

Our goods come with guarantees that cannot be excluded under the Australian Consumer Law. You are entitled to a replacement or refund for a major failure and compensation for any other reasonably foreseeable loss or damage. You are also entitled to have the goods repaired or replaced if the goods fail to be of acceptable quality and the failure does not amount to a major failure.

For New Zealand customers, this warranty is in addition to statutory rights observed under New Zealand legislation.

IMPORTANT!

For all technical queries or difficulties in operating the product and for spare parts, contact H.E. Group customer service 1300 105 888 (Australia) and 09 8870 447 (New Zealand).

