

# Assembly Instructions

## 43150861 LARGE WHITE CUPBOARD TROLLEY

























### CARE INSTRUCTION:

CHECK AND TIGHTEN ALL PARTS REGULARLY. WIPE CLEAN WITH A SOFT DRY OR DAMP CLOTH. FOR INDOOR AND DOMESTIC USE.

### WARNINGS:

DO NOT STAND OR SIT ON THE UNIT. DO NOT LEAN ON THE PRODUCT. DO NOT DRAG THE PRODUCT. USE ONLY ON A FLAT SURFACE. DO NOT USE UNTIL ALL SCREWS, BOLTS AND KNOBS ARE FIRMLY SECURED. THIS PRODUCT CONTAINS SMALL PARTS AND SHARP POINTS, KEEP AWAY FROM CHILDREN AND BABIES. ADULT ASSEMBLY REQUIRED. FAILURE TO FOLLOW THESE WARNINGS COULD RESULT IN SERIOUS INJURY.

**MAXIMUM SAFE LOAD: 20KG FOR TOP PANEL, 5KG FOR DRAWER, 5KG FOR SHELF, 1.5KG FOR TOWER RAIL.**

	a	6x35mm	16pcs		i		1pc		r		2pcs
	b		16pcs		j		1pc		s	6x70mm	8pcs
	c	3x12mm	23pcs		k		1pc		t		10pcs
	d	6x30mm	20pcs		l		1pc		u	6x40mm	2pcs
	e	4x35mm	12pcs		m		2pcs		v	6x30mm	4pcs
	f	4x25mm	4pcs		n		2pcs		w		4pcs
	g	4x20mm	2pcs		o		1pc		x	2x10mm	12pcs
	h	4x25mm	8pcs		p		1pc		y		1pc

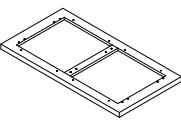
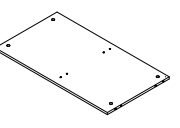
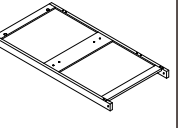
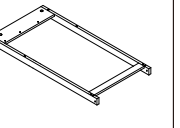
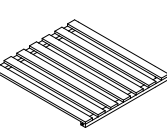
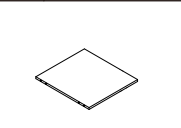
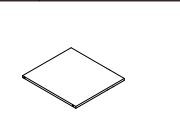
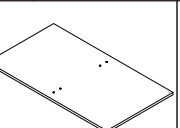
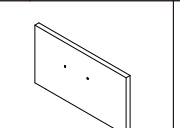
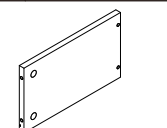
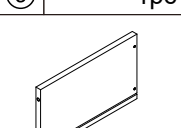
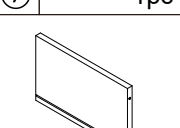
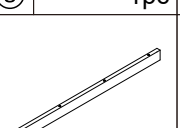
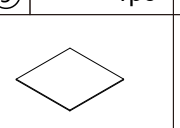
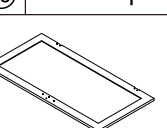
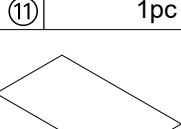
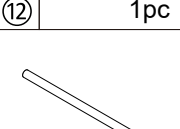
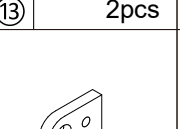
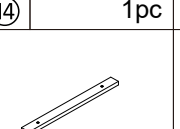
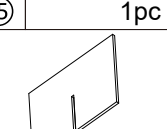
				
①	②	③	④	⑤
1pc	1pc	1pc	1pc	1pc
				
⑥	⑦	⑧	⑨	⑩
1pc	1pc	1pc	1pc	1pc
				
⑪	⑫	⑬	⑭	⑮
1pc	1pc	2pcs	1pc	1pc
				
⑯	⑰	⑱	⑲	⑳
1pc	1pc	2pcs	4pcs	2pcs

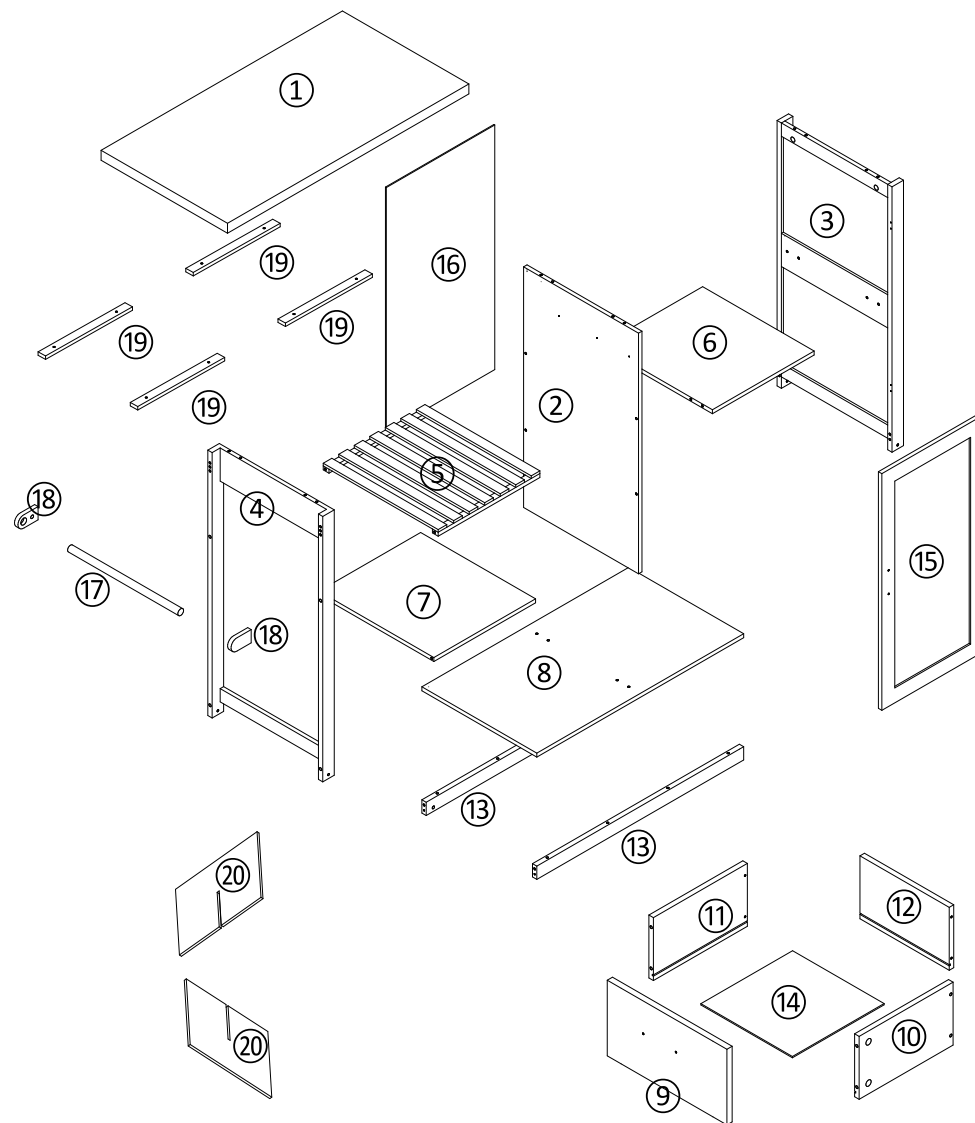

step 1

	jx1		ox1		cx5		ax2
--	-----	--	-----	--	-----	--	-----

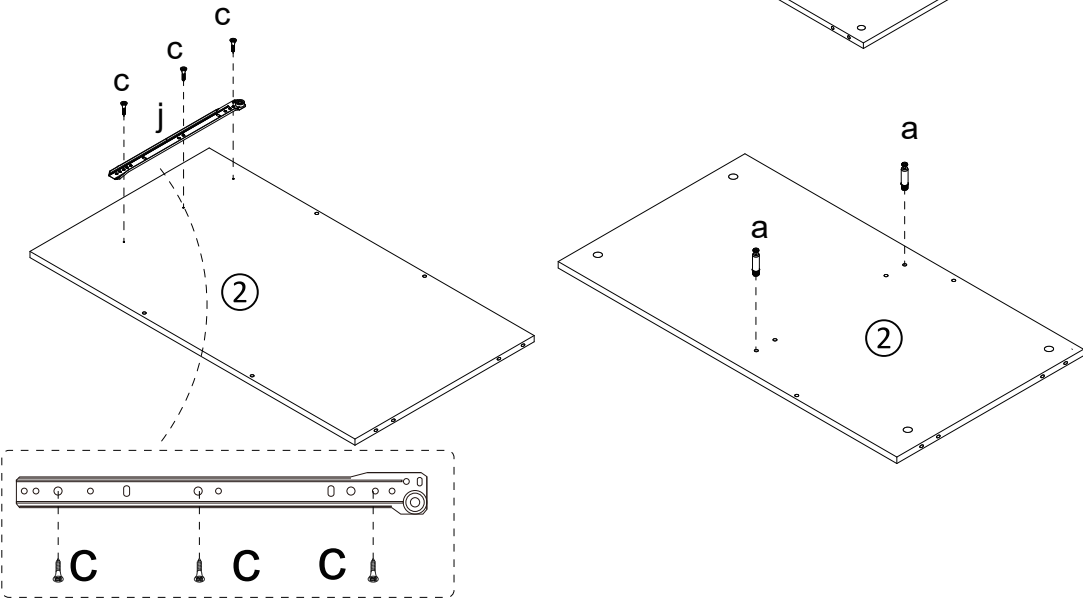

step 2

	tx2		dx2		ux2		bx2
--	-----	--	-----	--	-----	--	-----

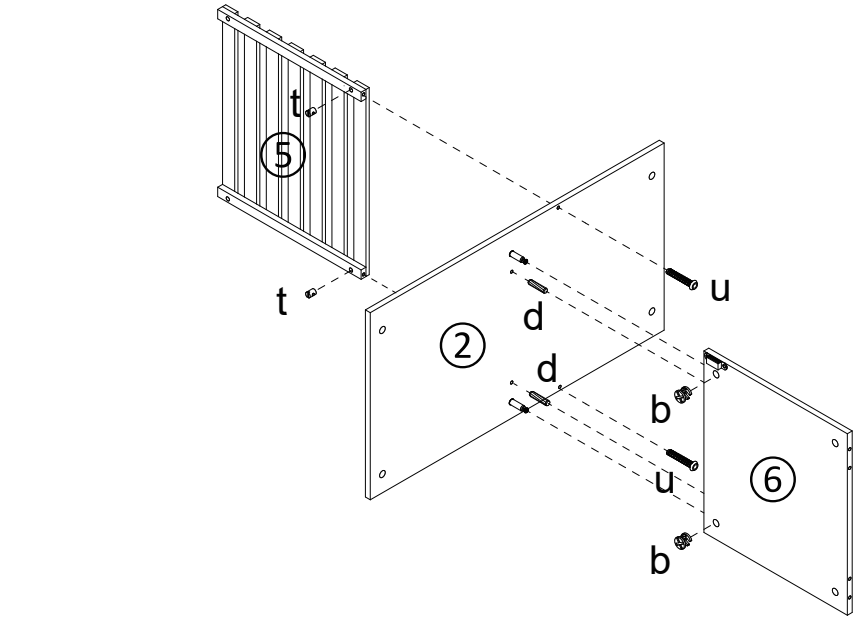

step 3

	ex8		ax2
--	-----	--	-----

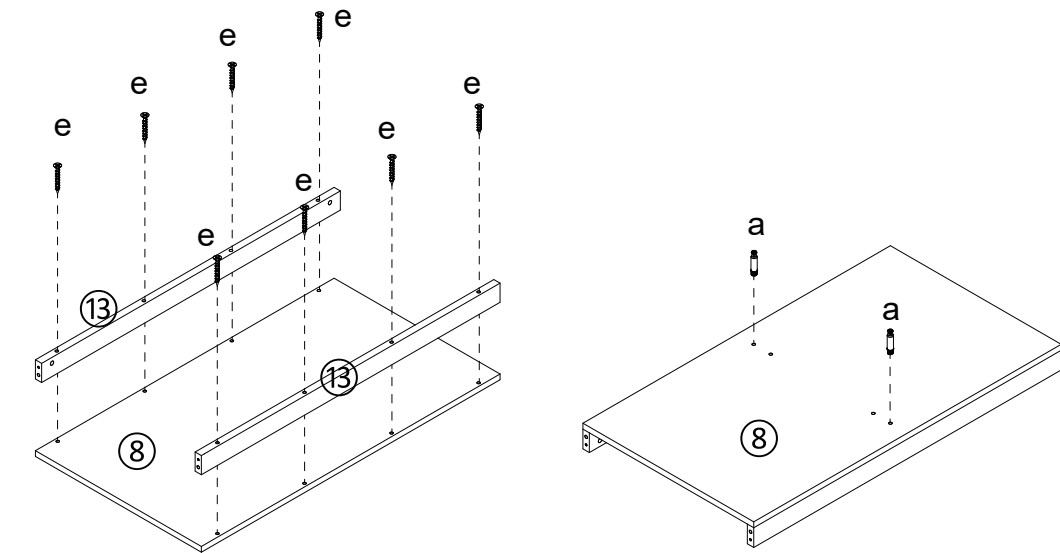

step 4

	cx3		ax2		mx2		nx2		wx4
	dx4		tx2		sx2		ix1		vx4

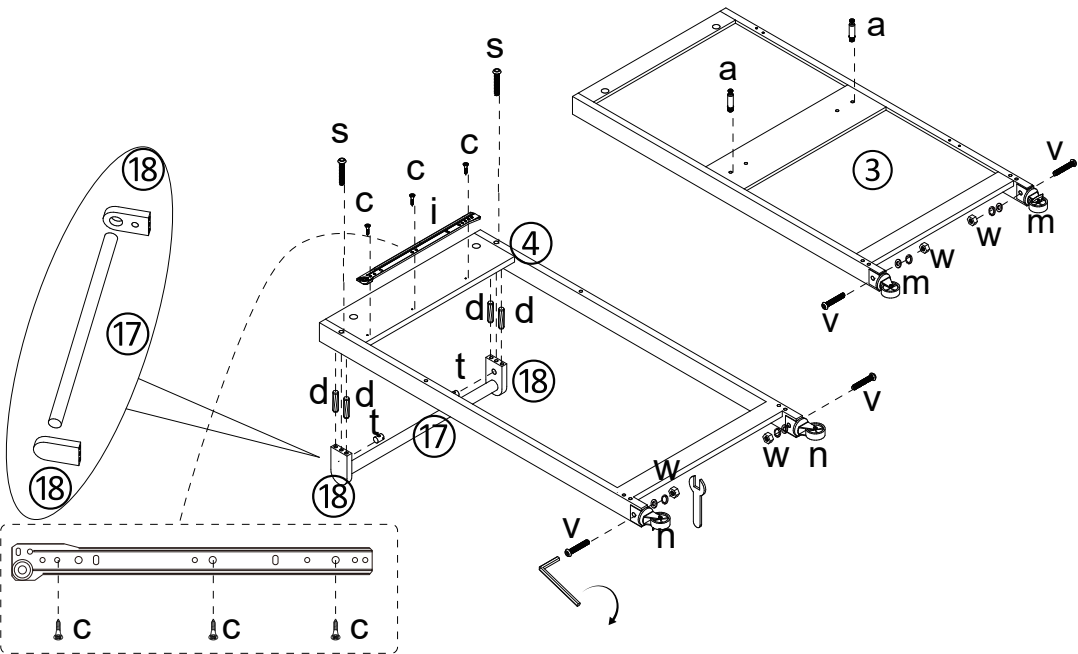

step 5

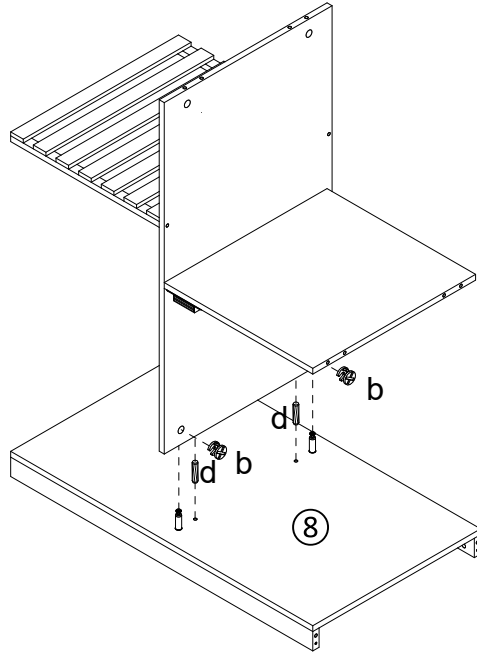
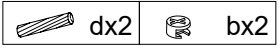

step 6

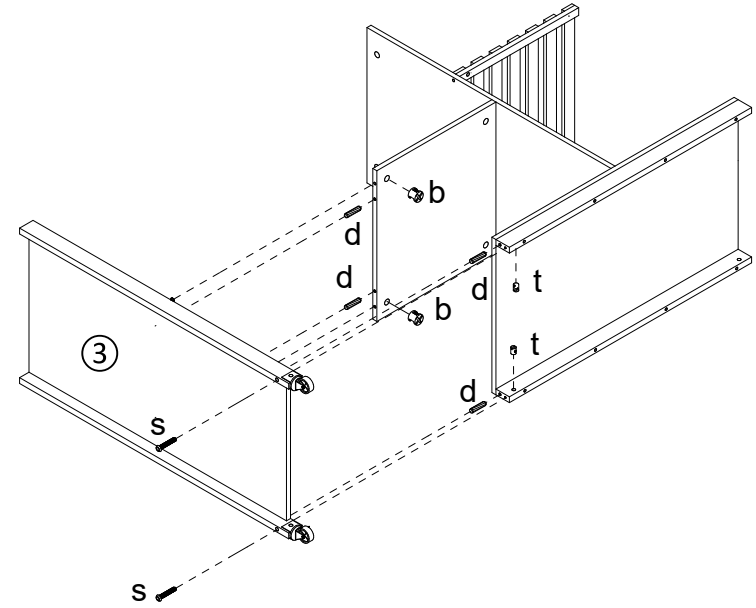
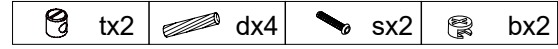

step 7

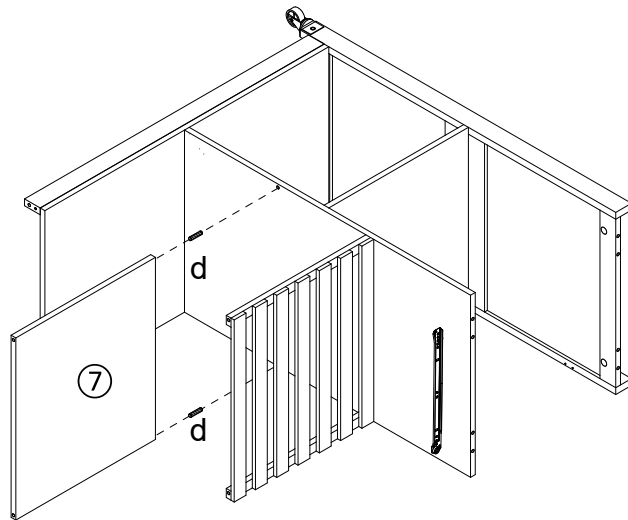

step 8

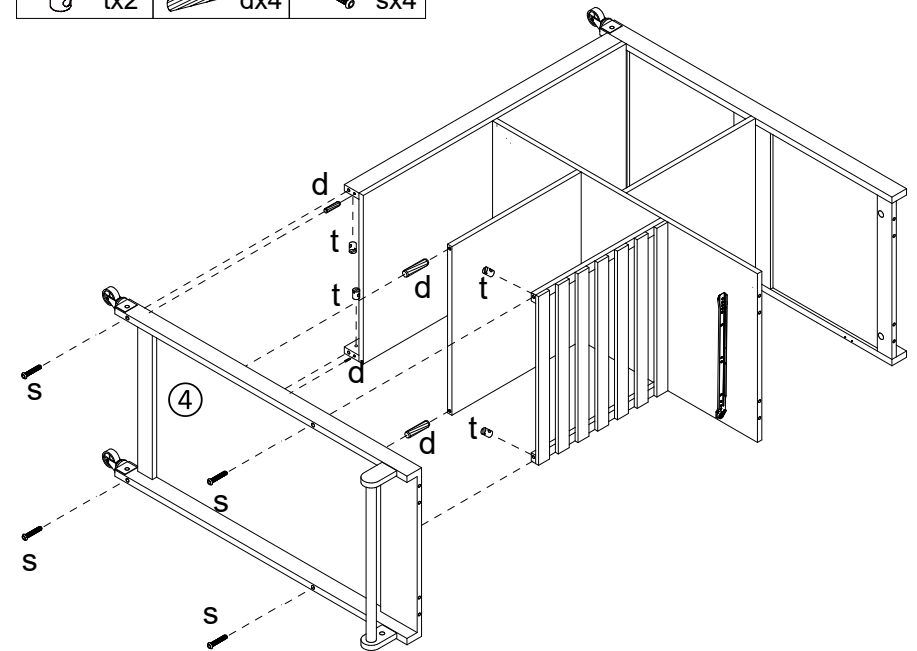

### step 9

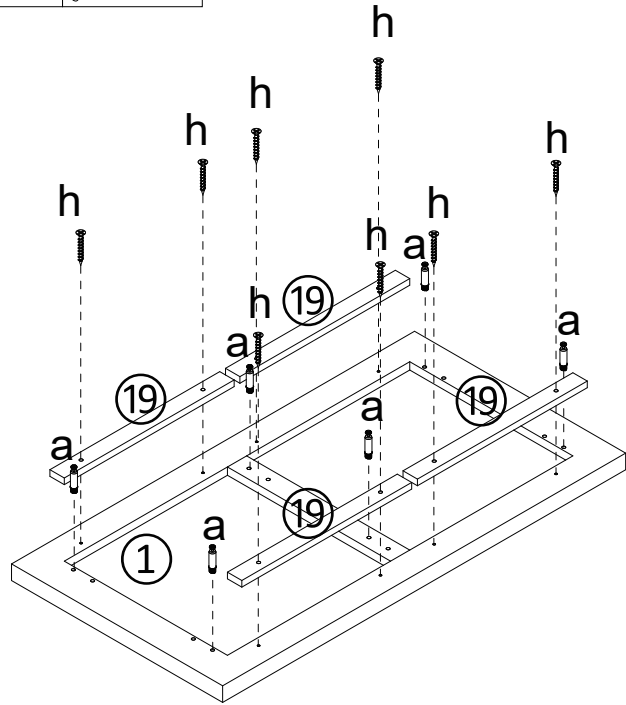
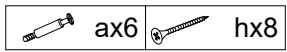

### step 10

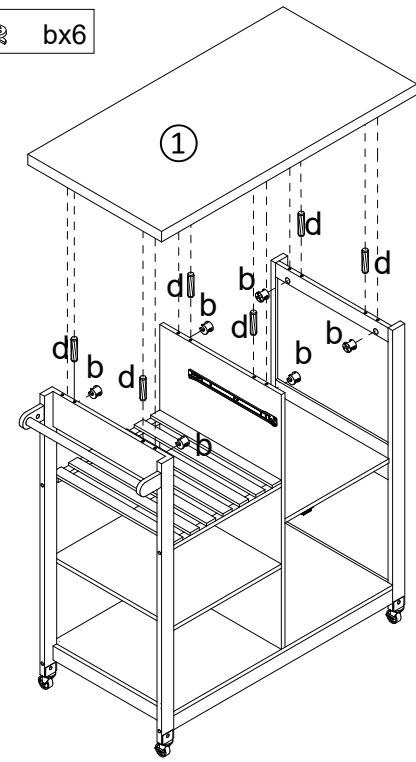
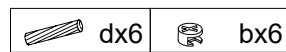



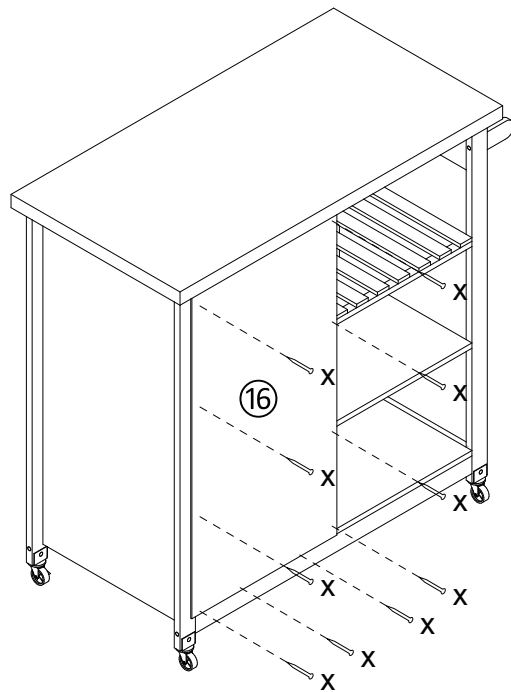
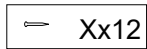

### step 11

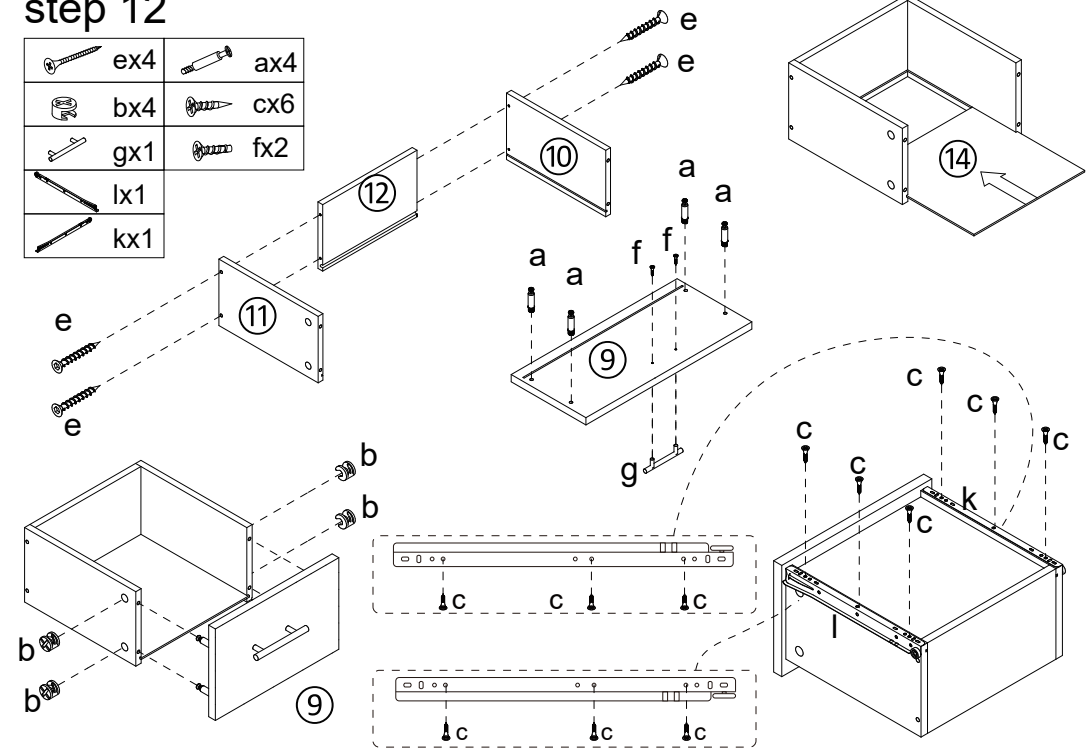
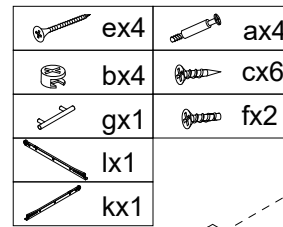

### step 12



### step 13

	cx9
	fx2
	gx1
	rx2
	px1

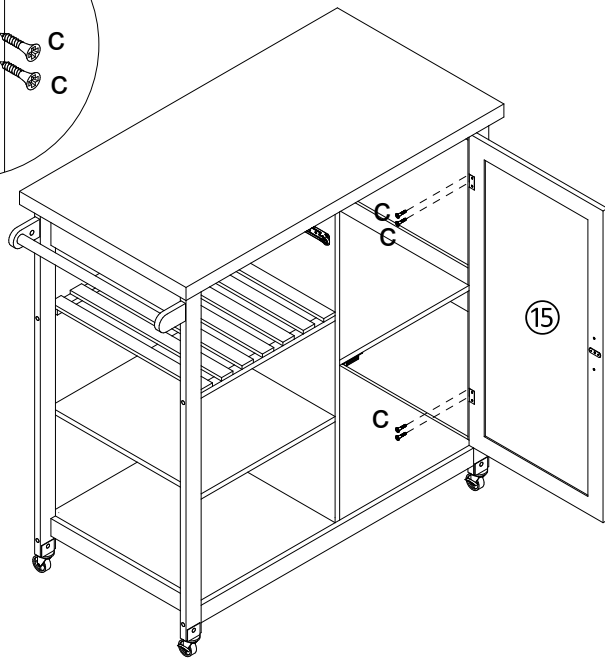
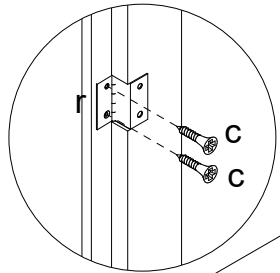
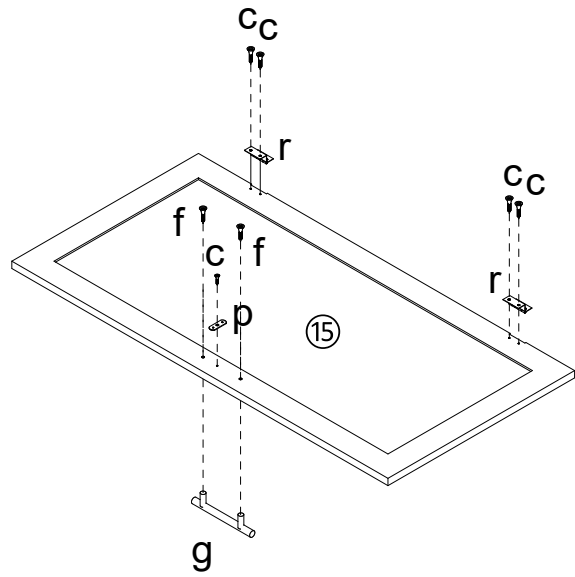

### step 14

