

Assembly Instructions

43150885 SCANDI BOOKSHELF TALL

CARE INSTRUCTIONS:







WIPE CLEAN WITH A DAMP OR DRY CLOTH. DO NOT USE ABRASIVE MATERIALS AND SOLVENTS. DO NOT PLACE HOT ITEMS SUCH AS COFFEE CUPS DIRECTLY ON THE SURFACE. KEEP AWAY FROM WATER AND DIRECT SUNLIGHT.

WARNING:





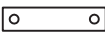



DO NOT STAND OR SIT ON THIS UNIT. DO NOT USE THIS UNIT UNLESS ALL BOLTS AND SCREWS ARE FIRMLY SECURED. USE ONLY ON A FLAT SURFACE. THIS PACKAGE CONTAINS SMALL PARTS AND SHARP POINTS KEEP AWAY FROM CHILDREN AND BABIES. ADULT ASSEMBLY REQUIRED. A MILD ODOUR MAY BE PRESENT WHEN FIRST OPENING THIS CARTON. SIMPLY ALLOW TO AIR OUTSIDE AND THIS WILL FADE.

MAXIMUM SAFE LOAD: LOADING: 3/5/7/9/11/13KG FROM TOP TO BOTTOM.

1 Hardware List

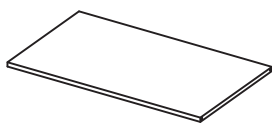
	A	M6x12mm	8pcs		B	M4*12mm	4pcs		C	Ø5*40mm	24pcs
	D	M4*35mm	2pcs		E	Ø6*30mm	2pcs		F		2pcs
	G	M3mm	1pc		H	M4mm	1pc				

2 Parts List

			
① 1pc	② 1pc	③ 1pc	④ 1pc
			
⑤ 1pc	⑥ 1pc	⑦ 2pcs	⑧ 2pcs
			
⑨ 1pc			

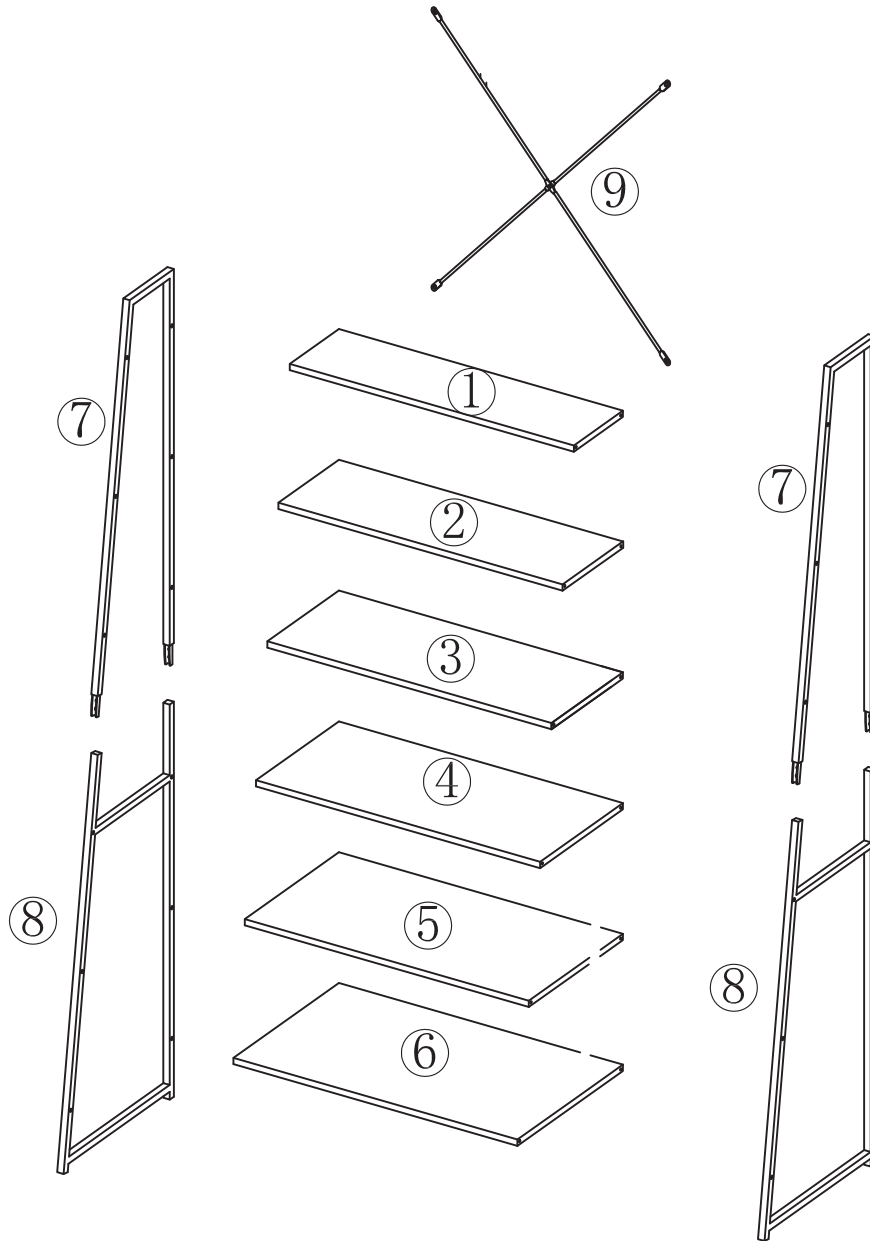

**Do not tighten the screws fully during assembly.
Fully tighten screws after the final assembly steps**

STEP 1 A -  x 8

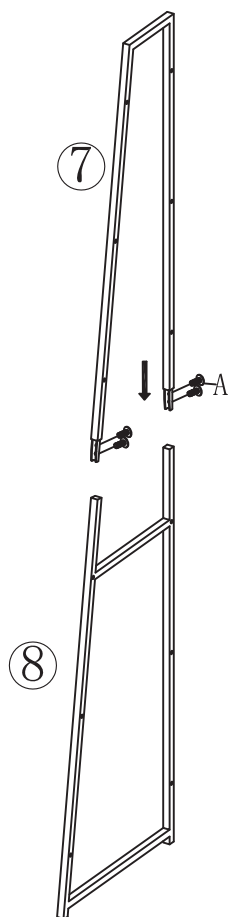



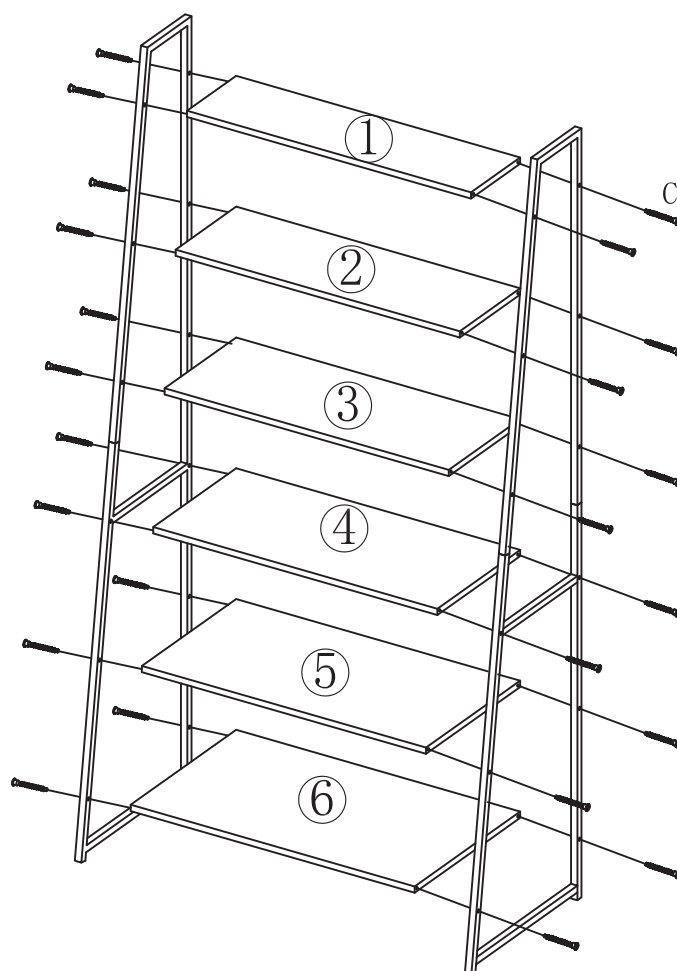

X2

STEP 2 C -  x 24

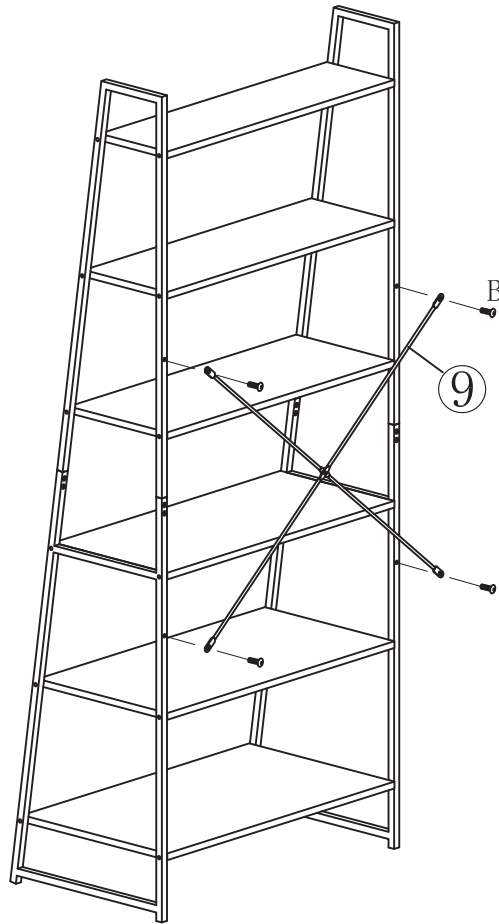

STEP 3 **B -  x 4**



STEP 4 **D -  x 2 E -  x 2 F -  x 2**

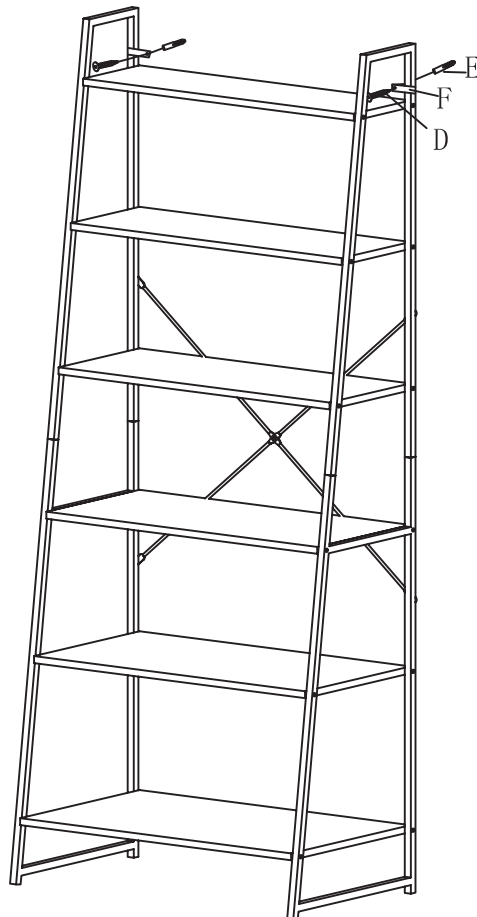

TOPPLING FURNITURE WARNING:

- It is strongly recommended that this product is permanently fixed to the wall.
- Please seek professional advice if you are in doubt of what fixing device to use.
- Regularly check that anchors are securely maintained.
- Stability of tall items may be affected by thick pile carpet or uneven floors .
- Do not place unanchored televisions on furniture .

CAUTION: for your safety when attaching the anchor fixings, please note the following:

- Check any electrical wires or plumbing inside the wall before drilling any holes (if you are unsure please seek professional advice from a qualified tradesperson).



WARNING: PLEASE SECURE YOUR FURNITURE WITH THE SUPPLIED WALL FIXING. SCAN THE CODE FOR MORE INFORMATION.

