

Assembly Instruction

43150977 LARGE 4 TIER BLACK SHELVING SET









CARE INSTRUCTION:

WIPE CLEAN WITH A SOFT DAMP CLOTH. NEVER USE SCOURERS, ABRASIVES OR CHEMICAL SOLVENTS. KEEP AWAY FROM MOISTURE AND DIRECT SUNLIGHT. STORE IN A DRY PLACE FOR INDOOR USE ONLY.

WARNING:

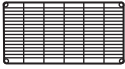
DO NOT STAND, SIT OR LEAN ON THE UNIT. DO NOT USE THIS UNIT AS A STEP LADDER. ENSURE THIS UNIT IS USED ONLY ON A FLAT SURFACE. DO NOT USE THIS UNIT UNLESS ALL PARTS ARE FIRMLY SECURED. LOAD THE SHELF EVENLY TO PREVENT IT FROM TOPPLING OVER. ITEM IS FOR STORAGE PURPOSE ONLY. FAILURE TO FOLLOW THESE WARNINGS COULD RESULT IN SERIOUS INJURY. CONTAINS SMALL PARTS. IT IS TO BE ASSEMBLED BY AN ADULT. **MAXIMUM SAFE LOAD: 50KGS FOR EACH SHELF.**

Hardware list

	A	Top pole	4pcs		E	Strap	2pcs
	B	Bottom pole	4pcs		F	Screw	2pcs
	C	Shelf	4pcs		G	Ring	2pcs
	D	Black clip	32pcs		H	Fastener	2pcs

STEP 1

 AX4  BX4  DX8

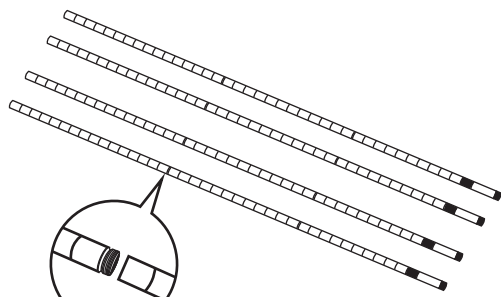

assembly instructions: start with the base shelf and build upwards.

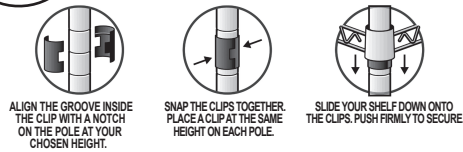

ALIGN THE GROOVE INSIDE THE CLIP WITH A NOTCH ON THE POLE AT YOUR CHOSEN HEIGHT.

SNAP THE CLIPS TOGETHER. PLACE A CLIP AT THE SAME HEIGHT ON EACH POLE.



SLIDE YOUR SHELF DOWN ONTO THE CLIPS. PUSH FIRMLY TO SECURE.

STEP 2

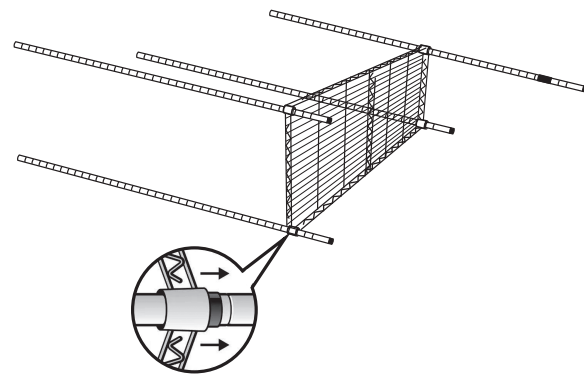
 CX1





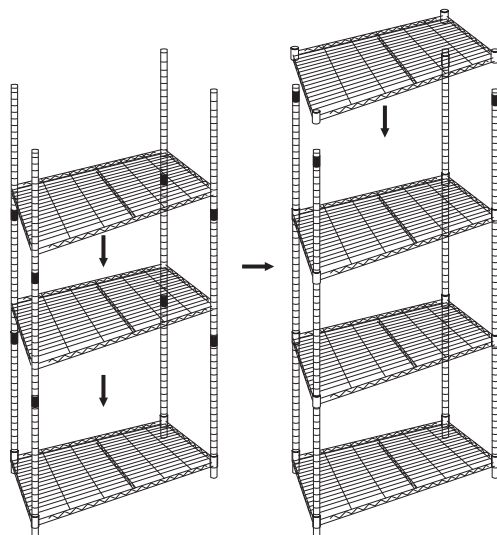

STEP 3

 CX3  DX24



STEP 4

 EX2  FX2  GX2  HX2

